



CONTRACT DOCUMENTS & SPECIFICATIONS

for

**18TH STREET- MOORES CREEK DRAINWAY TO DIERS AVENUE;
PROJECT NO. 2022-P-8**

Bid Opening

Tuesday, January 17, 2023 @ 2:00 pm
City of Grand Island, City Hall
100 East 1st Street
Grand Island, NE 68801

**ENGINEERING DIVISION
DEPARTMENT OF PUBLIC WORKS
GRAND ISLAND, NEBRASKA**

DECEMBER 2022

BIDDER CHECKLIST FOR

**18TH STREET- MOORES CREEK DRAINWAY TO DIERS AVENUE;
PROJECT NO. 2022-P-8**

CITY OF GRAND ISLAND, NEBRASKA

Bids must be received by the City Clerk before 2:00 p.m., (local time) on Tuesday, January 17, 2023.

The following items must be completed for your bid to be considered.

- This completed bidder checklist form.
 - A signed **original and one copy** of the bidding documents.
 - Acknowledgment of Addendum(s), if any.
 - Firm unit pricing; or lump sum pricing as applicable. (See bid Form)
 - A certified check, cashiers check or bid bond in a separate envelope attached to the **outside of the envelope containing the bid**. Each envelope must be clearly marked indicating its contents. Failure to submit the necessary qualifying information in clearly marked and separate envelopes will result in your bid not being opened.
 - Acknowledgement of **PERFORMANCE BOND** requirement on award of the Contract. The successful Contractor shall furnish a Performance Bond which shall be in an amount equal to the full contract price, guaranteeing faithful compliance with all requirements of the contract documents and complete fulfillment of the contract, and payment of all labor, material and other bills incurred in carrying out this contract. According to Nebraska Law, the surety company executing the Performance Bond must be authorized to do business in the State of Nebraska.
 - Acknowledgement of **PAYMENT BOND** requirement on award of the contract. The successful contractor shall furnish a Payment Bond which shall be in an amount equal to the full contract price, guaranteeing protection of all persons supplying labor and materials to the contractor or its subcontractors for the performance of the work provided for in the contract. In accordance with Nebraska Law, the surety company executing the Payment Bond must be authorized to do business in the State of Nebraska.
- * *If checked you will be claiming the individual pricing as listed on the Bid Form is proprietary information and should not be released under a public records request. The total amount of the bid is not considered proprietary information and will be released pursuant to City Procurement Code.*

Bidder Company Name

Date

Print – Name of Person Completing Bid

Signature

**18TH STREET- MOORES CREEK DRAINWAY TO DIERS AVENUE;
PROJECT NO. 2022-P-8**

CITY OF GRAND ISLAND, NEBRASKA

TABLE OF CONTENTS

1. Bidder Checklist
2. Table of Contents
3. Advertisement to Bidders
4. Contractor's Bid
5. Named Equipment/ Subcontractors Form
6. Instructions to Bidders
7. Insurance Requirements
8. Exempt Sales Certificate
9. Purchasing Agent Appointment
10. Contract Agreement
11. Division I - General Specifications
12. Division IA - Special Provisions
13. Division II – Portland Cement Concrete
14. Division III – Curb and Gutter, Sidewalks and Driveways
15. Division IV - Asphalt Concrete Surface Course
16. Division V – Storm and Sanitary Sewer
17. Division VI – Water Mains
18. Status of Utilities
19. Plan Sets

ADVERTISEMENT TO BIDDERS
for

**18TH STREET- MOORES CREEK DRAINWAY TO DIERS AVENUE;
PROJECT NO. 2022-P-8**

for
CITY OF GRAND ISLAND, NEBRASKA

Sealed bids will be **received at the office of the City Clerk**, 100 E. First Street., Grand Island, NE 68801 or P.O. Box 1968, Grand Island, Nebraska 68802 until **2:00 p.m., (Local Time), Tuesday, January 17, 2023** for the construction of **18th Street- Moores Creek Drainway to Diers Avenue** for the City of Grand Island. Bids will be publicly opened at this time in the Conference Room #1 located on 1st floor of City Hall. Bids received after specified time will be returned unopened to sender.

Bids shall be submitted on forms which will be furnished by the City OR bidding documents, plans, and specifications for use in preparing bids may be downloaded from the Quest CDN website, www.QuestCDN.com for a thirty dollar (\$30) fee. Bids must be uploaded to the Quest CDN website and received before the specified time to be considered. Each bidder shall submit with their bid a certified check, a cashiers check or bid bond payable to the City Treasurer in an amount no less than five percent (5%) of the bid price which shall guarantee good faith on the part of the bidder and the entering into a contract within fifteen (15) days, at the bid price, after acceptance by the City. **“Your certified check, cashiers check or bid bond must be submitted in a separate envelope attached to the outside of the envelope containing the bid.”** Each envelope must be clearly marked indicating its contents. **Failure to submit the necessary qualifying information in clearly marked and separate envelopes will result in your bid not being opened or considered.** OR Bid bonds must be uploaded to Quest CDN, www.QuestCDN.com. Bid bonds must be issued by surety companies authorized to do business in the State of Nebraska. **Please return one original and one copy of each bid sheet.**

The successful bidder will be required to comply with fair labor standards as required by Nebraska R.R.S. 73-102 and comply with Nebraska R.R.S. 48-657 pertaining to contributions to the Unemployment Compensation Fund of the State of Nebraska.

Successful bidder shall comply with the City's insurance requirements, and supply performance and payment bonds. Successful bidder shall maintain a Drug Free Workplace Policy.

Bids will be evaluated by the Purchaser based on price, quality, adherence to schedule, plan and specification, economy and efficiency of operation, experience and reputation of bidder, ability, capacity, and skill of the bidder to perform contract required and adaptability of the particular items to the specific use intended.

The Purchaser reserves the right to reject any or all bids and to waive irregularities therein and to accept whichever bid that may be in the best interest of the City, at its sole discretion.

GRATUITIES AND KICKBACKS: City Code states that it is unethical for any person to offer, give, or agree to give any City employee or former City employee, or for any City employee or former City employee to solicit, demand, accept, or agree to accept from another person, a gratuity or an offer of employment in connection with any decision, approval, disapproval, recommendation, or preparation of any part of a program requirement or a purchase request, influencing the content of any specification or procurement standard, rendering of advice, investigation, auditing, or in any other advisory capacity in any proceeding or application, request for ruling, determination, claim or controversy, or other particular matter, pertaining to any program requirement or a contract or

subcontract, or to any solicitation or proposal therefore. It shall be unethical for any payment, gratuity, or offer of employment to be made by or on behalf of a subcontractor under a contract to the prime contractor or higher tier subcontractor or any person associated therewith, as an inducement for the award of a subcontract to order.

No bidder may withdraw their bid for a period of forty-five (45) days after date of opening bids.

TITLE VI: The City of Grand Island, in accordance with Title VI of the Civil Rights Act of 1964, 78 Stat. 252, 42 U.S.C 2000d to 2000d-4 and Title 49, Code of Federal Regulations, Department of Transportation, Subtitle A, Office the Secretary, Part 21, Nondiscrimination in Federally assisted programs of the Department of Transportation issued pursuant to such Act, hereby notified all bidden that it will affirmatively insure that in any contact entered into pursuant to this advertisement, minority business enterprises will be afforded full opportunity to submit bids in response to this invitation and will not be discriminated against on the grounds of race, color, or national origin, sex, age and disability/handicap in consideration for an award.

SECTION 504/ADA NOTICE TO THE PUBLIC: The City of Grand Island does not discriminate on the basis of disability in admission of its programs, services, or activities, in access to them, in treatment of individuals with disabilities, or in any aspect of their operations. The City of Grand Island also does not discriminate on the basis of disability in its hiring or employment practices.

This notice is provided as required by Title II of the Americans with Disabilities Act of 1990 and Section 504 of the Rehabilitation Act of 1973. Questions, complaints, or requests for additional information or accommodation regarding the ADA and Section 504 may be forwarded to the designated ADA and Section 504 compliance coordinator.

City Administrator
308-389-0140
100 East First Street, Grand Island, NE 68801
Monday through Friday; 8:00 a.m. to 5:00 p.m.

Plans and specifications for use in preparing bids may be obtained from the office of the City Engineer, Second Floor, City Hall, 100 East First Street, Grand Island, NE.

RaNae Edwards
City Clerk

CONTRACTOR'S BID

**18TH STREET- MOORES CREEK DRAINWAY TO DIERS AVENUE;
PROJECT NO. 2022-P-8**

CITY OF GRAND ISLAND, NEBRASKA

CONTRACTOR'S BID

TO THE MEMBERS OF THE COUNCIL
CITY OF GRAND ISLAND
GRAND ISLAND, NEBRASKA

THE UNDERSIGNED BIDDER, having examined the plans, specifications, general and special conditions, and other proposed contract documents, and all addenda thereto and being acquainted with and fully understanding (a) the extent and character of the work covered by this Bid, (b) the location, arrangement, and specified requirements for the proposed work, (c) the location, character, and condition of existing streets, roads, highways, railroad, pavements, surfacing, walks, driveways, curbs, gutters, trees, sewers, utilities, drainage courses and structures, and other installations, both surface and underground which may affect or be affected by the proposed work, (d) the nature and extent of the excavations to be made and the handling and re-handling of excavated materials, (e) the location and extent of necessary or probable dewatering requirements, (f) the difficulties and hazards to the work which might be caused by storm and flood water, (g) local conditions relative to labor, transportation, hauling and rail delivery facilities, and (h) all other factors and conditions affecting or which may be affected by the work.

HEREBY PROPOSES to furnish all required materials, supplies, equipment, tools and plans, to perform all necessary labor and supervision, and to construct, install, erect, equip and complete all work stipulated in, required by and in accordance with the contract documents and the plans, specifications and other documents referred to therein (as altered, amended or modified by all addenda thereto) for and in consideration of the following prices:

BASE BID SECTION

| Item No. | Item | Est. Quantity | Unit | Unit Price | Extended Price |
|----------|---------------------------------------|---------------|------|------------|----------------|
| 1 | MOBILIZATION | 1.00 | LS | \$ | \$ |
| 2 | 8" CONCRETE PAVEMENT W/ INTEGRAL CURB | 5,606.00 | SY | \$ | \$ |
| 3 | 7" CONCRETE PAVEMENT | 907.00 | SY | \$ | \$ |
| 4 | 6" CONCRETE PAVEMENT | 702.00 | SY | \$ | \$ |
| 5 | 5" CONCRETE SIDEWALK | 893.00 | SY | \$ | \$ |
| 6 | DETECTABLE WARNING PANEL | 110.00 | SF | \$ | \$ |
| 7 | STORM SEWER MANHOLE | 3.00 | EA | \$ | \$ |
| 8 | STORM SEWER CURB INLET | 8.00 | EA | \$ | \$ |

| | | | | | |
|----|--|----------|-----|----|----|
| 9 | STORM SEWER AREA INLET | 4.00 | EA | \$ | \$ |
| 10 | STORM SEWER COLLAR | 2.00 | EA | \$ | \$ |
| 11 | 15" REINFORCED CONCRETE STORM SEWER PIPE | 589.00 | LF | \$ | \$ |
| 12 | 18" REINFORCED CONCRETE STORM SEWER PIPE | 384.00 | LF | \$ | \$ |
| 13 | 24" REINFORCED CONCRETE STORM SEWER PIPE | 125.00 | LF | \$ | \$ |
| 14 | 30" REINFORCED CONCRETE STORM SEWER PIPE | 401.00 | LF | \$ | \$ |
| 15 | 30" REINFORCED CONCRETE FLARED END SECTION | 1.00 | EA | \$ | \$ |
| 16 | RECONSTRUCT MANHOLE | 1.00 | EA | \$ | \$ |
| 17 | ADJUST MANHOLE TO GRADE | 4.00 | EA | \$ | \$ |
| 18 | 6" PVC SANITARY SEWER SERVICE | 24.00 | LF | \$ | \$ |
| 19 | 6" PVC SANITARY SEWER CAP | 1.00 | EA | \$ | \$ |
| 20 | CONNECT TO EXISTING SEWER SERVICE | 1.00 | EA | \$ | \$ |
| 21 | 8" D.I. WATER MAIN | 492.00 | LF | \$ | \$ |
| 22 | FIRE HYDRANT ASSEMBLY, TYPE 1 | 1.00 | EA | \$ | \$ |
| 23 | FIRE HYDRANT ASSEMBLY, TYPE 2 | 1.00 | EA | \$ | \$ |
| 24 | 8" GATE VALVE W/ BOX | 1.00 | EA | \$ | \$ |
| 25 | DUCTILE IRON FITTINGS | 1,165.00 | LBS | \$ | \$ |
| 26 | 8" TAPPING SLEEVE AND VALVE W/ BOX | 2.00 | EA | \$ | \$ |
| 27 | IN-LINE I BEAM BLOCK | 2.00 | EA | \$ | \$ |
| 28 | 2" CORPORATION STOP | 1.00 | EA | \$ | \$ |
| 29 | 2" CURB STOP | 1.00 | EA | \$ | \$ |
| 30 | 2" WATER SERVICE | 59.00 | LF | \$ | \$ |
| 31 | RECONNECT WATER SERVICE | 1.00 | EA | \$ | \$ |
| 32 | CONCRETE JOINT ENCASEMENT | 4.00 | EA | \$ | \$ |
| 33 | TESTING AND SAMPLING TAP | 2.00 | EA | \$ | \$ |
| 34 | REMOVE AND SALVAGE FIRE HYDRANT | 2.00 | EA | \$ | \$ |

| | | | | | |
|----|--|----------|-----|----|----|
| 35 | ABANDON VALVE | 1.00 | EA | \$ | \$ |
| 36 | DEWATERING- WATER MAIN | 1.00 | LS | \$ | \$ |
| 37 | ROADWAY SIGN | 4.00 | EA | \$ | \$ |
| 38 | STREET NAME SIGN | 6.00 | EA | \$ | \$ |
| 39 | TELESPAR SIGN POST | 8.00 | EA | \$ | \$ |
| 40 | PERMANENT BARRICADE, TYPE III | 2.00 | EA | \$ | \$ |
| 41 | 12" WHITE PERMANENT PAVEMENT MARKING, PAINT, GROOVED | 20.00 | LF | \$ | \$ |
| 42 | PARKING LOT PAVEMENT MARKING | 1.00 | LS | \$ | \$ |
| 43 | RESET PARKING LOT LIGHT POLE | 2.00 | EA | \$ | \$ |
| 44 | REMOVE PAVEMENT | 5,606.00 | SY | \$ | \$ |
| 45 | REMOVE SIDEWALK | 51.00 | SY | \$ | \$ |
| 46 | REMOVE STORM SEWER MANHOLE | 2.00 | EA | \$ | \$ |
| 47 | REMOVE STORM SEWER CURB INLET | 2.00 | EA | \$ | \$ |
| 48 | REMOVE STORM SEWER AREA INLET | 2.00 | EA | \$ | \$ |
| 49 | REMOVE STORM SEWER FLARED END SECTION | 1.00 | EA | \$ | \$ |
| 50 | REMOVE STORM SEWER PIPE | 490.00 | LF | \$ | \$ |
| 51 | REMOVE AND SALVAGE LIGHT POLE | 4.00 | EA | \$ | \$ |
| 52 | REMOVE AND RESET COMMUNITY MAILBOX | 1.00 | EA | \$ | \$ |
| 53 | REMOVE AND RESET MAILBOX | 1.00 | EA | \$ | \$ |
| 54 | SODDING | 1,979.00 | SY | \$ | \$ |
| 55 | SEEDING | 1.10 | AC | \$ | \$ |
| 56 | HYDROMULCHING | 1.70 | TON | \$ | \$ |
| 57 | WATERING | 8.80 | AC | \$ | \$ |
| 58 | EROSION CONTROL MAT | 160.00 | SY | \$ | \$ |
| 59 | EROSION CONTROL LINEAR | 522.00 | LF | \$ | \$ |

| | | | | | |
|----|---|----------|----|----|----|
| 60 | INLET SEDIMENT FILTER | 11.00 | EA | \$ | \$ |
| 61 | COVER CROP SEEDING | 2.00 | AC | \$ | \$ |
| 62 | SPRINKLER REPAIR | 1.00 | LS | \$ | \$ |
| 63 | TEMPORARY TRAFFIC CONTROL | 1.00 | LS | \$ | \$ |
| 64 | TEMPORARY CRUSHED ROCK SURFACING | 100.00 | TN | \$ | \$ |
| 65 | FOUNDATION COURSE- STRUCTURES | 10.00 | TN | \$ | \$ |
| 66 | FOUNDATION COURSE- ROADWAY | 1,000.00 | TN | \$ | \$ |
| 67 | GENERAL CLEARING AND GRUBBING | 1.00 | LS | \$ | \$ |
| 68 | SUBGRADE PREPARATION | 5,606.00 | SY | \$ | \$ |
| 69 | OVER-EXCAVATION | 3,100.00 | CY | \$ | \$ |
| 70 | REMOVAL AND REPLACEMENT OF UNSUITABLE MATERIALS | 1,000.00 | CY | \$ | \$ |
| 71 | EARTHWORK | 1.00 | LS | \$ | \$ |

TOTAL BASE BID= \$ _____

ALTERNATE BID SECTION

| Item No. | Item | Est. Quantity | Unit | Unit Price | Extended Price |
|----------|---|---------------|------|------------|----------------|
| 2A | 8" DOWELED CONCRETE PAVEMENT W/ INTEGRAL CURB | 5,606.00 | SY | \$ | \$ |

TOTAL ALTERNATE BID= \$ _____

EXPERIENCE DATA:

Each bidder shall supply the following data on their experience:

Name of Bidder: _____

Project Owner/Contact/Phone No. _____ Project Location _____ Completion Date _____

Additional Data: _____

INSURANCE: Bidder acknowledges that bid includes compliance with the attached insurance requirements.

ADDENDA:
Bidder acknowledges that the following Addendums were received and considered in Bid preparation.

| <u>ADDENDUM NO.</u> | <u>DATE</u> | <u>SIGNATURE</u> |
|---------------------|-------------|------------------|
| _____ | _____ | _____ |
| _____ | _____ | _____ |

Exceptions shall be listed in the following blanks. If additional space is required for exception explanation, please reference and attach a letter to bid. Reference shall not be made to other attachments for exceptions and supplementary terms. Failure to outline such exceptions as specifically stated herein will require the successful bidder to comply with these specifications. In case of conflict between the bid and these specifications, these specifications shall govern unless specific exceptions are listed by the bidder.

Exceptions to specifications, pages _____

The undersigned bidder agrees to furnish the required performance and payment bond and to enter into a contract within fifteen (15) days after acceptance of this Bid, and further agrees to complete all work covered by the foregoing bid in accordance with specified requirements. **No work shall commence until the Certificate of Insurance and bonds (when required) are approved by the City and the contract is executed.** The proposed work can commence after the contract is signed and the required bond is approved.

Completion: All contract work shall be substantially completed by **September 1, 2023** and ready for final acceptance by **November 30, 2023**. Substantially complete is defined that all pavements including driveways, sidewalks, and striping is completed and open to traffic. Final acceptance is defined that all items are complete for the project including any final punch list items and establishment of all seeded areas.

Liquidated Damages: It is understood and agreed that time is the essence of the contract. Should the Contractor fail to perform all of the work within the overall period of time stipulated in the Contract Agreement, the Contractor shall pay to the City, as liquidated damages and not as a penalty, **\$350.00 per calendar** day of default unless extensions of time granted by the City specifically provide for the waiving of liquidated damages.

The City shall have the right to deduct the liquidated damages from any moneys in its hands, otherwise due, or to become due, to the Contractor, or to use for and recover compensation for damages for non-performance of this contract within the time stipulated.

Enclosed herewith is the required bid guarantee in the amount of _____ Dollars (\$_____)

which the undersigned bidder agrees is to be forfeited to and become the property of the City of Grand Island, Nebraska, as liquidated damages should this Bid be accepted and a contract be awarded to them and they fail to enter into a contract in the form prescribed and to furnish the required bond within fifteen (15) days, but otherwise the aforesaid bid guarantee will be returned upon signing the contract and delivering the approved bond.

In submitting the bid it is understood that the right is reserved by the City to reject any and all bids; to waive irregularities therein and to accept whichever bid that may be in the best interest of the City. It is understood that this bid may not be withdrawn by the bidder until after forty-five (45) days from bid opening.

In submitting the bid, the bidder states that bidder fully complies with, and will continue to comply with, applicable State fair labor standards as required by section 73-102 RRS, 1943 and also complies with, and will continue to comply with, section 48-657 RRS, 1943 pertaining to contributions to the Unemployment Compensation Fund of the State of Nebraska.

In submitting this bid, the bidder states that a bidder's authorized representative visited the site of the work and thoroughly informed themselves of all conditions and factors which would affect the work and the cost thereof.

Site Inspected By: _____

Date: _____

The undersigned bidder hereby certifies (a) that this bid is genuine and is not made in the interest of or in the behalf of any undisclosed person, firm or corporation, and is not submitted in conformity with any agreement or rules of any group, association, organization or corporation, (b) that they have not directly or indirectly induced or solicited any person, firm or corporation to refrain from bidding, (c) that they have not sought, by collusion or otherwise, to obtain for themselves an advantage over any other bidder or over the City of Grand Island, and (d) that they have not directly or indirectly induced or solicited any other bidder to put in a false or sham bid.

DATED _____

SIGNATURE OF BIDDER:

If an Individual: _____ doing business
as _____

If a Partnership: _____
by _____, member of firm.

If a Corporation: _____
by _____ (Seal)
Title

BUSINESS ADDRESS OF BIDDER

TELEPHONE NUMBER OF BIDDER

EMAIL

NAMED EQUIPMENT / SUBCONTRACTORS

Bidders shall enter the names of manufacturers for items of equipment proposed to be furnished. Substitutions will not be permitted unless the proposed equipment does not meet the specifications or the manufacturer of the proposed equipment is unable to meet delivery requirements of the construction schedule.

Acceptance of the named equipment as part of the bid shall not constitute a waiver of specifications covering such equipment. Final acceptance shall be based upon review of shop drawings of the proposed equipment.

| <i>Equipment</i> | <i>Manufacturer</i> |
|-------------------------|----------------------------|
| | |
| | |
| | |
| | |

LIST OF SUBCONTRACTORS

Bidders shall enter the names of subcontractors to be used in performing the work. If any of the following work is to be self-performed, fill in the name of the Bidder. Bidder certifies that all subcontractors listed are eligible to perform the work. The City reserves the right to reject any listed subcontractor(s).

| <i>Subcontractor's Work</i> | <i>Subcontractor's Name</i> |
|------------------------------------|------------------------------------|
| | |
| | |
| | |
| | |
| | |
| | |

Failure to furnish the information requested on this form may be cause for rejection of the bid.

Bidder: _____

INSTRUCTIONS TO BIDDERS

INSTRUCTIONS TO BIDDERS

18TH STREET- MOORES CREEK DRAINWAY TO DIERS AVENUE; PROJECT NO. 2022-P-8

CITY OF GRAND ISLAND, NEBRASKA

EXCEPTIONS TO SPECIFICATIONS: Each bidder shall carefully check all requirements herein set forth and shall offer items which fully comply with these requirements or shall plainly set forth all points, features, conditions, specifications of items that are non-compliant. Bidder must comply with all applicable Federal, State and Local rules and regulations.

SUBMISSION OF BIDS: All bids shall be submitted using the City's bid form. Bids shall **be addressed to the City Clerk** and plainly marked, **"BID FOR 18TH STREET- MOORES CREEK DRAINWAY TO DIERS AVENUE; PROJECT NO. 2022-P-8"**.

INSURANCE COVERAGE: The Contractor shall purchase and maintain at their expense as a minimum insurance coverage of such types and in such amounts as are specified herein to protect Contractor and the interest of Owner and others from claims which may arise out of or result from Contractor's operations under the Contract Documents, whether such operations be by Contractor or by any subcontractor or anyone directly or indirectly employed by any of them or for whose acts any of them may be legally liable. Failure of Contractor to maintain proper insurance coverage shall not relieve them of any contractual responsibility or obligation.

BASE BID: The bidder is expected to base their bids on materials and items complying fully with these specifications, and in the event the contractor names in the bid materials items which do not conform, they will be responsible for furnishing materials and items which fully conform at no change in the bid price.

BIDDER QUALIFICATION: Bids will be received only from qualified bidders. A bidder will be considered qualified if they are a recognized manufacturer or supplier of materials and items similar to that specified herein with complete factory facilities in the United States and has had experience in the design and manufacture of items of equal or greater size than that specified herein. If requested, the Bidder shall supply experience data. Such data will be used to assist in determining the qualifications of the Bidder. Bidder must comply with all applicable Federal, State and Local rules and regulations.

GRATUITIES AND KICKBACKS: City Code states that it is unethical for any person to offer, give, or agree to give any City employee or former City employee, or for any City employee or former City employee to solicit, demand, accept, or agree to accept from another person, a gratuity or an offer of employment in connection with any decision, approval, disapproval, recommendation, or preparation of any part of a program requirement or a purchase request, influencing the content of any specification or procurement standard, rendering of advice, investigation, auditing, or in any other advisory capacity in any proceeding or application, request for ruling, determination, claim or controversy, or other particular matter, pertaining to any program requirement or a contract or subcontract, or to any solicitation or proposal therefore. It shall be unethical for any payment, gratuity, or offer of employment to be made by or on behalf of a subcontractor under a contract to the prime contractor or higher tier subcontractor or any person associated therewith, as an inducement for the award of a subcontract to order.

CHECKS OR BID BONDS: Checks or bid bonds of the unsuccessful bidders will be returned when their bids have been rejected and not to exceed forty-five (45) days from the date bids are opened. All bids shall remain in force for this forty-five (45) day Period. The check or bid bond of the successful bidder will be returned when the Contracts are signed by both parties and necessary bonds supplied. Should the Purchaser make an award to a Contractor who refuses to enter into a Contract and furnish the required bonds within fifteen (15) days after notification of acceptance, then the bid security which has been deposited with the Purchaser will be forfeited to the Purchaser as liquidated damages.

PERFORMANCE BOND: When required, on award of the Contract, the successful Contractor shall furnish a Performance Bond which shall be in an amount equal to the full Contract price, guaranteeing faithful compliance with all requirements of the Contract Documents and complete fulfillment of the Contract, and payment of all labor, material and other bills incurred in carrying out this Contract. According to Nebraska Law, the surety company executing the Performance Bond must be authorized to do business in the State of Nebraska.

PAYMENT BOND: When required, on award of the Contract, the successful Contractor shall furnish a Payment Bond which shall be in an amount equal to the full Contract price, guaranteeing protection of all persons supplying labor and materials to the Contractor or its subcontractors for the performance of the work provided for in the Contract. In accordance with Nebraska Law, the surety company executing the Payment Bond must be authorized to do business in the State of Nebraska.

TAXES: The City of Grand Island is exempt from paying local City and State Sales Tax for materials incorporated into the work. Refer to Exempt Sale Certificate enclosed for your information. Contractor must pay any other tax which might be applicable.

REQUESTS FOR PAYMENT: The City of Grand Island will make payments only after approval at regularly scheduled City Council meetings. These meetings typically occur the second and fourth Tuesday each month. Requests for payment must be received no less than ten (10) working days prior to the designated meeting to allow proper review and consideration. Progress Payments will be permitted during the project, so long as work is being done to the City's satisfaction unless otherwise stated in bidding documents.

REQUEST FOR INTERPRETATION: If any person, contemplating submitting a bid for this Contract is in doubt as to the true meaning of any part of the specifications or other proposed Contract documents, they may submit to the Purchasing Department a written request for an interpretation thereof. The person submitting the request will be responsible for its prompt delivery. Any interpretation of the proposed documents will be made by addendum only issued and/or delivered to each person receiving a set of such documents. The addenda upon closing shall become a part of the Contract. The Purchasing Department will not be responsible for any other explanation or interpretation of the proposed documents.

TIME OF COMPLETION: All contract work shall be substantially completed by **September 1, 2023** and ready for final acceptance by **November 30, 2023**. Substantially complete is defined that all pavements including driveways, sidewalks, and striping is completed and open to traffic. Final acceptance is defined that all items are complete for the project including any final punch list items and establishment of all seeded areas.

LIQUIDATED DAMAGES: It is understood and agreed that time is the essence of the contract. Should the Contractor fail to perform all of the work within the overall period of time stipulated in the Contract Agreement, the Contractor shall pay to the City, as liquidated damages and not as a penalty, **\$350.00** per **calendar** day of default unless extensions of time granted by the City specifically provide for the waiving of liquidated damages.

The City shall have the right to deduct the liquidated damages from any moneys in its hands, otherwise due, or to become due, to the Contractor, or to use for and recover compensation for damages for non-performance of this contract within the time stipulated.

CLEANING UP: Contractor shall maintain a clean and safe work area while on site.

ADDENDA: Any addendum to the specifications issued during the time allowed for preparation of bids shall be covered in the bid and shall become a part of the specifications. Addendums issued before the date of the letting will be sent to all bidders. One signed copy is to be returned immediately to the Purchasing Department (or other department if so designated in the Addendum) as acknowledgment of receipt.

MODIFICATION OF BIDS: Bids may be modified or withdrawn by an appropriate document duly executed in the manner that a bid must be executed and delivered to the place where bids are to be submitted at any time prior to the final time set for receiving bids. Bidders may modify or withdraw bids by Fax communication at any time prior to the time set for receiving bids provided this instruction is positively identified. Any Fax modification should not reveal the amended bid price but should provide only the addition, subtraction or other modifications. A duly-executed document confirming the Fax modification shall be submitted within three days after bids are opened.

BID DATA: Bidders shall submit bid data, if required, on items offered in the Bid by **furnishing one original and one copy of the completed Contractor's Bid form**. The bid sheets shall be filled out legibly in ink to permit reproduction.

BIDDER SECURITY: Bidder security, when required, shall be enclosed in a separate envelope marked, "**BIDDER SECURITY/BID FOR 18TH STREET- MOORES CREEK DRAINWAY TO DIERS AVENUE; PROJECT NO. 2022-P-8**". The envelope shall contain only a cashier's check, certified check or bidder's bond payable to the City of Grand Island Treasurer in an amount no less than five (5) percent of the bid price which shall guarantee good faith on the part of the bidder and the entering into a contract within fifteen (15) days, at the bid price, after acceptance by the City. **Failure to submit the necessary qualifying information in clearly marked and separate envelopes will result in your bid not being opened or considered. OR Bid bonds must be uploaded to Quest CDN, www.QuestCDN.com.** Bid bonds must be issued by surety companies authorized to do business in the State of Nebraska.

This separate envelope shall be attached to a sealed envelope containing the bid and any other bid materials. This second envelope shall be labeled "BID FOR 18TH STREET- MOORES CREEK DRAINWAY TO DIERS AVENUE; PROJECT NO. 2022-P-8" and be addressed to the City Clerk. Bids of an incomplete nature or subject to multiple interpretation may, at the option of the Purchaser, be rejected as being irregular.

FINANCIAL STATEMENT: The bidder shall furnish, upon request, a complete financial statement signed by the bidder, if an individual, by all partners if the bidder is a partnership and, by the President or Secretary, if the bidder is a corporation.

DRUG FREE WORKPLACE POLICY: Bidders shall furnish, upon request, a copy of their Drug Free workplace Policy.

EQUAL EMPLOYMENT OPPORTUNITY: The Contractor agrees that during the performance of this Contract not to discriminate in hiring or any other employment practice on the basis of race, color, religion, sex, disability, age or national origin, and to comply with Executive Order 11,246 of September 24, 1965, and the rules, regulations and relevant orders of the Secretary of Labor, and Chapter 20 of the Reissue Revised Statutes of the State of Nebraska.

LOCAL CONDITIONS: Each bidder shall have an authorized representative visit the site of the work and thoroughly inform them of all conditions and factors which would affect the work and the cost thereof, including the arrangement and conditions of existing or proposed structures affecting or affected by the proposed work; the procedure necessary for maintenance of uninterrupted operation; the availability and cost of labor and facilities for transportation, handling, and storage of materials and equipment.

TILE VI: The City of Grand Island, in accordance with Title VI of the Civil Rights Act of 1964, 78 Stat. 252, 42 U.S.C 2000d to 2000d-4 and Title 49, Code of Federal Regulations, Department of Transportation, Subtitle A, Office the Secretary, Part 21, Nondiscrimination in Federally assisted programs of the Department of Transportation issued pursuant to such Act, hereby notified all bidden that it will affirmatively insure that in any contract entered into pursuant to this advertisement, minority business enterprises will be afforded full opportunity to submit bids in response to this invitation and will not be discriminated against on the grounds of race, color, or national origin, sex, age and disability/handicap in consideration for an award.

SECTION 504/ADA NOTICE TO THE PUBLIC: The City of Grand Island does not discriminate on the basis of disability in admission of its programs, services, or activities, in access to them, in treatment of individuals with disabilities, or in any aspect of their operations. The City of Grand Island also does not discriminate on the basis of disability in its hiring or employment practices. This notice is provided as required by Title II of the Americans with Disabilities Act of 1990 and Section 504 of the Rehabilitation Act of 1973. Questions, complaints, or requests for additional information or accommodation regarding the ADA and Section 504 may be forwarded to the designated ADA and Section 504 compliance coordinator.

City Administrator
308-389-0140
100 East First Street, Grand Island, NE 68801
Monday through Friday; 8:00 a.m. to 5:00 p.m.

It must be understood and agreed that all such factors have been investigated and considered in the preparation of every bid submitted. No claims for financial adjustment to any Contract awarded for the work under these Specifications and documents will be permitted by the City, which are based on lack of such prior information, or its effect on the cost of the work.

CORRESPONDENCE: Correspondence regarding drawings, instruction manuals, and other engineering data shall be clearly marked "FOR ENGINEERING DEPARTMENT" and sent through:

City of Grand Island
Public Works Department/Engineering Division
P.O. Box 1968
Grand Island, NE 68802-1968
(308) 385-5455
Attn: Keith Kurz

LOCAL BIDDER PREFERENCE: In case of tied low bids, all other things being equal, preference shall be given in the following order:

1. To those bidders who manufacture their products within the limits of the City of Grand Island.
2. To those bidders who manufacture their products within the limits of the County of Hall.
3. To those bidders who package, process, or through some other substantial operation have employees and facilities for these purposes in the City of Grand Island.
4. To those bidders who package, process, or through some other substantial operation have employees and facilities for these purposes in the County of Hall.
5. To those bidders who maintain a bona fide business office in the City of Grand Island, whose products may be made outside the confines of the City of Grand Island.
6. To those bidders who maintain a bona fide business office in the County of Hall, whose products may be made outside the confines of the County of Hall.
7. To those bidders whose commodities are manufactured, mined, produced, or grown within the State of Nebraska, and to all firms, corporations, or individuals doing business as Nebraska firms, corporations or individuals, when quality is equal or better, and delivered price is the same or less than the other bids received.
8. To those bidders whose commodities are manufactured, mined, produced, or grown within the United States of America, and to all firms, corporations, or individuals doing business as firms registered in states other than Nebraska, when quality is equal or better, and delivered price is the same or less than the other bids received.

INSURANCE REQUIREMENTS

MINIMUM INSURANCE REQUIREMENTS

**18TH STREET- MOORES CREEK DRAINWAY TO DIERS AVENUE;
PROJECT NO. 2022-P-8**

CITY OF GRAND ISLAND, NEBRASKA

You are urged to include in your bid compliance with the City’s minimum insurance requirements; however, any non-compliance must be detailed in the Exceptions Section of the bid. Compliance with the specified OCP coverage is mandatory.

The successful bidder shall obtain insurance from companies authorized to do business in Nebraska of such types and in such amounts as may be necessary to protect the bidder and the interests of the City against hazards or risks of loss as hereinafter specified. This insurance shall cover all aspects of the Bidder's operations and completed operations. Failure to maintain adequate coverage shall not relieve bidder of any contractual responsibility or obligation. Minimum insurance coverage shall be the amounts stated herein or the amounts required by applicable law, whichever are greater.

1. WORKERS COMPENSATION AND EMPLOYER'S LIABILITY

This insurance shall protect the Bidder against all claims under applicable State workers compensation laws. This insurance shall provide coverage in every state in which work for this project might be conducted. The liability limits shall not be less than the following:

| | |
|----------------------|-------------------------|
| Workers Compensation | Statutory Limits |
| Employers Liability | \$100,000 each accident |
| | \$100,000 each employee |
| | \$500,000 policy limit |

2. BUSINESS AUTOMOBILE LIABILITY

This insurance shall be written in comprehensive form and shall protect the Bidder, Bidder's employees, or subcontractors from claims due to the ownership, maintenance, or use of a motor vehicle. The liability limits shall be not less than the following:

| | |
|---------------------------------|----------------------------------|
| Bodily Injury & Property Damage | \$ 500,000 Combined Single Limit |
|---------------------------------|----------------------------------|

3. COMPREHENSIVE GENERAL LIABILITY

The comprehensive general liability coverage shall contain no exclusion relative to explosion, collapse, or underground property. The liability limits shall be not less than the following:

| | |
|---------------------------------|----------------------------|
| Bodily Injury & Property Damage | \$ 500,000 each occurrence |
| | \$1,000,000 aggregate |

4. UMBRELLA LIABILITY INSURANCE

This insurance shall protect the Bidder against claims in excess of the limits provided under employer's liability, comprehensive automobile liability, and commercial general liability policies. The umbrella policy shall follow the form of the primary insurance, including the application of the primary limits. The liability limits shall not be less than the following:

| | |
|---------------------------------|-------------------------------|
| Bodily Injury & Property Damage | \$1,000,000 each occurrence |
| | \$1,000,000 general aggregate |

5. ADDITIONAL REQUIREMENTS

The City may require insurance covering a Bidder or subcontractor more or less than the standard requirements set forth herein depending upon the character and extent of the work to be performed by such Bidder or subcontractor.

Insurance as herein required shall be maintained in force until the City releases the Bidder of all obligations under the Contract.

The Bidder shall provide and carry any additional insurance as may be required by special provisions of these specifications.

6. CERTIFICATE OF INSURANCE

Satisfactory certificates of insurance shall be filed with the City prior to starting any work on this Contract. **The certificates shall show the City as an additional insured on all coverage except Workers Compensation. The certificate shall state that thirty (30) days written notice shall be given to the City before any policy is cancelled (strike the "endeavor to" wording often shown on certificate forms). If the bidder cannot have the "endeavor to" language stricken, the bidder may elect to provide a new certificate of insurance every 30 days during the contract. Bidder shall immediately notify the City if there is any reduction of coverage because of revised limits or claims paid which affect the aggregate of any policy.**

EXEMPT SALE CERTIFICATE

TAX FORM 13

| Name and Mailing Address of Purchaser | | | Name and Mailing Address of Seller | | |
|---------------------------------------|-------|----------|------------------------------------|-------|----------|
| Name | | | Name | | |
| Legal Name | | | | | |
| Street Address (Do not use PO Box) | | | Street or Other Mailing Address | | |
| City | State | Zip Code | City | State | Zip Code |

Check Type of Certificate

- Single Purchase If single purchase is checked, enter the related invoice or purchase order number _____.
- Blanket If blanket is checked, this certificate is valid until revoked in writing by the purchaser.

I hereby certify that the purchase, lease, or rental by the above purchaser is exempt from the Nebraska sales tax for the following reason:

- Check One** Purchase for Resale (Complete Section A.) Exempt Purchase (Complete Section B.) Contractor (Complete Section C.)

Section A—Nebraska Resale Certificate

Description of Property or Service Purchased

I hereby certify that the purchase, lease, or rental of _____ from the seller listed above is exempt from the Nebraska sales tax as a purchase for resale, rental, or lease in the normal course of our business. The property or service will be resold either in the form or condition in which it was purchased, or as an ingredient or component part of other property or service to be resold.

I further certify that we are engaged in business as a: Wholesaler Retailer Manufacturer Lessor
of _____
Description of Product or Service Sold, Leased, or Rented

My Nebraska Sales Tax Permit Number is 01-_____.

If none, state the reason _____.

or Foreign State Sales Tax Number _____ State _____.

Section B—Nebraska Exempt Sale Certificate

The basis for this exemption is exemption category _____ (insert appropriate number for the category of exemption described on the reverse side).

If exemption category 2 or 5 is claimed, enter the following information:

Description of Items Purchased _____ Intended Use of Items Purchased _____.

If exemption category 3 or 4 is claimed, enter your Nebraska Exemption Certificate number. 05-_____
Do **not** enter your Federal Employer ID Number.

If exemption category 6 is claimed, the seller must enter the following information and sign this form below:

| | | | |
|---------------------------|------------------------------------|--|---|
| Description of Items Sold | Date of Seller's Original Purchase | Was tax paid when purchased by seller? <input type="checkbox"/> Yes <input type="checkbox"/> No | Was item depreciable? <input type="checkbox"/> Yes <input type="checkbox"/> No |
|---------------------------|------------------------------------|--|---|

Section C—For Contractors Only

1. Purchase of building materials or fixtures.

- As an Option 1 or Option 3 contractor, I hereby certify that the purchase of building materials and fixtures from the seller listed above are exempt from Nebraska sales tax. My Nebraska Sales or Use Tax Permit Number is: _____.

2. Purchases made by an Option 2 contractor under a Purchasing Agent Appointment on behalf of _____
(exempt entity)

As an Option 2 contractor, I hereby certify that the purchase of building materials and fixtures from the seller listed above is exempt from Nebraska sales tax pursuant to the **attached** Purchasing Agent Appointment and Delegation of Authority for Sales and Use Tax, Form 17.

Any purchaser, agent, or other person who completes this certificate for any purchase which is not for resale, lease, or rental in the regular course of the purchaser's business, or is not otherwise exempted from sales and use taxes is subject to a penalty of \$100 or ten times the tax, whichever amount is larger, for each instance of presentation and misuse. With regard to a blanket certificate, this penalty applies to each purchase made during the period the blanket certificate is in effect. Under penalties of law, I declare that I am authorized to sign this certificate, and to the best of my knowledge and belief, it is correct and complete.

**sign
here** ▶

Authorized Signature _____ Title _____ Date _____

Stacy R. Nonhof

Authorized Signature Name (please print)

Do not send this certificate to the Nebraska Department of Revenue. Keep it as part of your records.

Sellers cannot accept incomplete certificates.

revenue.nebraska.gov, 800-742-7474 (NE and IA), 402-471-5729

Instructions

Who May Issue a Resale Certificate. Form 13, Section A, is issued by persons or organizations making purchases of property or taxable services that will subsequently be resold in the purchaser's normal course of business. The property or services must be resold in the same form or condition as when purchased, or as an ingredient or component part of other property that will be resold.

Who May Issue an Exempt Sale Certificate. Form 13, Section B, may only be issued by governmental units and persons or organizations that are exempt from paying Nebraska sales and use tax. Nonprofit organizations that are exempt from paying sales and use tax are listed in the [Nebraska Sales Tax Exemption Chart](#).

Enter the appropriate number from the "Categories of Exemption" in the space provided that properly reflects the basis for your exemption. If category 2 through 6 is the basis for exemption, you must complete the information requested in Section B.

For additional information about proper issuance and use of this certificate, please review [Reg-1-013, Sale for Resale – Resale Certificate](#), and [Reg-1-014, Exempt Sale Certificate](#).

Contractors. To make tax-exempt purchases of building materials and fixtures, Option 1 or Option 3 contractors must complete Form 13, Section C, Part 1.

To make tax-exempt purchases of building materials and fixtures pursuant to a construction project for an exempt governmental unit or an exempt nonprofit organization, Option 2 contractors must complete Form 13, Section C, Part 2. The contractor must also attach a copy of a properly completed [Purchasing Agent Appointment and Delegation of Authority for Sales and Use Tax, Form 17](#), to the Form 13, and both documents must be given to the supplier when purchasing building materials. See the [contractor information guides](#) for additional information.

When and Where to Issue. The Form 13 must be given to the seller at the time of the purchase to document why sales tax does not apply to the purchase. The Form 13 must be kept with the seller's records for audit purposes (see [Reg-1-012, Exemptions](#)). Do not send Forms 13 to the Nebraska Department of Revenue.

Sales Tax Number. A purchaser who is engaged in business as a wholesaler or manufacturer is not required to provide an ID number when completing Section A. Out-of-state purchasers may provide their home state sales tax number. Section B does not require a Nebraska ID number when exemption category 1, 2, or 5 is indicated.

Fully Completed Resale or Exempt Sale Certificate. For a resale certificate to be fully completed, it must include: (1) identification of the purchaser and seller, type of business engaged in by the purchaser, and reason for the exemption; (2) sales tax permit number; (3) signature of an authorized person; and (4) the date of issuance.

For an exempt sale certificate to be fully completed, it must include: (1) identification of purchaser and seller; (2) a statement that the certificate is for a single purchase or is a blanket certificate covering future sales; (3) a statement of the basis for exemption, including the type of activity engaged in by the purchaser; (4) signature of an authorized person; and (5) the date of issuance.

Penalties. Any purchaser who gives a Form 13 to a seller for any purchase which is other than for resale, lease, or rental in the normal course of the purchaser's business, or is not otherwise exempted from sales and use tax under the Nebraska Revenue Act, is subject to a penalty of \$100 or ten times the tax, whichever is greater, for each instance of presentation and misuse. In addition, any purchaser, or

their agent, who fraudulently signs a Form 13 may be found guilty of a Class IV misdemeanor.

Categories of Exemption

1. Governmental agencies identified in [Reg-1-012, Exemptions](#); [Reg-1-072, United States Government and Federal Corporations](#); and [Reg-1-093, Governmental Units](#). Governmental units are not assigned exemption numbers.

Sales to the United States government, its agencies, instrumentalities, and corporations wholly owned by the U.S. government are exempt from sales tax. However, sales to institutions chartered or created under federal authority, but which are not directly operated and controlled by the United States government for the benefit of the public, generally are taxable. For construction projects for federal agencies, see [Reg-1-017, Contractors](#).

Purchases by governmental units that are **not** exempt from Nebraska sales and use taxes include, but are not limited to: governmental units of other states; sanitary and improvement districts; rural water districts; railroad transportation safety districts; and county historical or agricultural societies.

2. Purchases when the intended use renders it exempt as stated in paragraph 012.02D of [Reg-1-012, Exemptions](#). See [Nebraska Sales Tax Exemption Chart](#). Complete the description of the item purchased and the intended use on the front of Form 13.

Beginning October 1, 2014, sales of repair and replacement parts for agricultural machinery and equipment used in commercial agriculture are exempt from sales and use taxes. When claiming this exemption, please enter "commercial agriculture" on the **Intended Use of Items Purchased** line.

3. Purchases made by organizations that have been issued a Nebraska Exempt Organization Certificate of Exemption. [Reg-1-090, Nonprofit Organizations](#); [Reg-1-091, Religious Organizations](#); and [Reg-1-092, Educational Institutions](#), identify these organizations. These organizations are issued a Nebraska state exemption ID number. This exemption number must be entered in Section B of Form 13.

Nonprofit **health care organizations** that hold a certificate of exemption are exempt for purchases of items for use at their facility, or portion of the facility, covered by the license issued under the Health Care Facility Licensure Act. Only specific types of health care facilities and activities are exempt. Purchases of items for use at facilities that are not covered under the license, or for any other activities that are not specifically exempt, are taxable.

4. Purchases of common or contract carrier motor vehicles, trailers, and semitrailers; accessories that physically become part of a common or contract carrier vehicle; and repair and replacement parts for these vehicles. The exemption number must be entered in Section B of the Form 13.
5. Purchases of manufacturing machinery and equipment made by a person engaged in the business of manufacturing, including repair and replacement parts or accessories, for use in manufacturing.
6. Occasional sales of used business or farm machinery or equipment productively used by the seller as a depreciable capital asset for more than one year in his or her business. The seller must have previously paid tax on the item being sold. The seller must complete, sign, and give the exemption certificate to the purchaser.

**PURCHASING AGENT
APPOINTMENT**

TAX FORM 17

Purchasing Agent Appointment and Delegation of Authority for Sales and Use Tax

PURCHASING AGENT APPOINTMENT

| Name and Address of Prime Contractor | | | Name and Address of Governmental Unit or Exempt Organization | | |
|--------------------------------------|-------|----------|--|-------|----------|
| Name | | | Name | | |
| Street or Other Mailing Address | | | Street or Other Mailing Address | | |
| City | State | Zip Code | City | State | Zip Code |
| Name and Location of Project | | | Appointment Information | | |
| Name | | | Effective Date (see Instructions) | | |
| Street or Other Mailing Address | | | Expiration Date | | |
| City | State | Zip Code | Nebraska Exemption Number (Exempt Organizations Only) | | |
| Identify Project | | | | | |

The undersigned governmental unit or exempt organization appoints the above-named contractor and the contractor's delegated subcontractors as its agent to purchase and pay for building materials that will be annexed to real estate by them into the tax exempt construction project stated above.

**sign
here** ▶

Authorized Signature of Governmental Unit or Exempt Organization

Title

Date

DELEGATION OF PRIME CONTRACTOR'S AUTHORITY

| Name and Address of Subcontractor | | | Delegation Information | | |
|-----------------------------------|-------|----------|------------------------|--|--|
| Name | | | Effective Date | | |
| Street or Other Mailing Address | | | Expiration Date | | |
| City | State | Zip Code | Portion of Project | | |

The undersigned prime contractor hereby delegates authority to act as the purchasing agent of the named governmental unit or exempt organization to the above-named subcontractor.

**sign
here** ▶

Signature of Prime Contractor or Authorized Representative

Title

Date

INSTRUCTIONS

WHO MUST FILE. Any governmental unit or organization that is **exempt** from sales and use tax may appoint as its agent a prime contractor to purchase building materials and/or fixtures that will be annexed to property that belongs to or will belong to the governmental unit or exempt organization pursuant to a construction contract with the governmental unit or exempt organization. The appointment of the prime contractor as its agent is completed by issuing a Purchasing Agent Appointment and Delegation of Authority for Sales and Use Tax, Form 17, to the prime contractor. The Form 17 is required to be given to the contractor **BEFORE** he or she annexes building materials. The governmental unit or exempt organization must identify the project (e.g., east wing, chapel construction, or new school auditorium). Most

nonprofit organizations are NOT exempt from sales tax in Nebraska. In addition, not all governmental units are exempt from Nebraska sales tax. Refer to [Contractor Information](#) on our Web site for additional information on exempt entities. A contractor can confirm the exempt status of a governmental unit or exempt organization by contacting the Nebraska Department of Revenue.

The exemption from the payment of the Nebraska and local option sales and use taxes only applies if the governmental unit or exempt organization directly, or through its contractor, pays for the building materials. **IMPORTANT NOTE:** When an organization that requires licensure in order to be exempt (i.e., nonprofit hospitals), but is not licensed at the time of the construction project, the exempt organization **CANNOT**

issue either a purchasing agent appointment or an exemption certificate. If the exempt organization becomes licensed upon completion of the project, it may apply for a refund of the tax paid or collected by the contractors.

WHEN TO FILE. A prime contractor engaging in a construction project with a governmental unit or exempt organization must receive a properly completed and signed Form 17 **BEFORE** any building materials are annexed. If Form 17 is not issued, the contractor must pay the sales and use taxes and the governmental unit or exempt organization may obtain a refund of the taxes paid by the contractor.

WHERE TO FILE. A copy of the completed form should be retained by the governmental unit or exempt organization issuing the Form 17. The original is to be retained by the prime contractor. Copies of this form must be made by the prime contractor for delegation purposes to any subcontractors working on the project identified on this form.

APPOINTMENT INFORMATION. Enter the dates the purchasing agent appointment will become effective and when it will expire. This appointment will not allow any purchases without payment of the tax by the prime contractor or subcontractor before the effective date or after the expiration date. The dates the delegation becomes effective and the expiration dates must be completed. The phrase “upon completion” or similar phrase is not acceptable as an expiration date. The governmental unit or exempt organization may need to issue another Form 17 if the project is not completed within the prior “effective” and “expiration” dates. Exempt organizations must enter their Nebraska Sales and Use Tax Exemption number.

DELEGATION OF PRIME CONTRACTOR’S AUTHORITY. The prime contractor may delegate his or her authority to act as the purchasing agent of the governmental unit or exempt organization to a subcontractor. The prime contractor must complete his or her copy of Form 17 for each subcontractor who is delegated authority to act as a purchasing agent. Reproductions of this delegation must be provided to the subcontractor, who must retain a copy for his or her records, and to the governmental unit or exempt organization.

Enter the dates the delegation of the subcontractor will become effective, when it will expire, and the portion of the project delegated. This delegation will not allow any purchases without payment of the tax by the subcontractor before the delegation date or after the expiration date. Any further delegation from a subcontractor to additional subcontractors must be delegated by providing a copy of the Form 17 that they received from the prime contractor and attaching it to a separate Form 17 with any further delegation to other subcontractors. The purchasing agent appointment is limited to the contractor’s purchase of building materials and/or fixtures for the specific project and is only valid during the appointment dates shown on the Form 17.

EXEMPT SALE CERTIFICATE. A prime contractor who has been appointed to act as a purchasing agent by a governmental unit or exempt organization, and who hires a subcontractor operating as an Option 1 contractor, must provide to that subcontractor a completed copy of Form 17 and a [Nebraska Resale or Exempt Sale Certificate, Form 13](#), with Section C,

Part 2, completed. The subcontractor will retain these forms in his or her records, and will not charge the contractor sales tax on any portion of the invoice involving the annexation of materials to the specific project identified on the Form 17. If these forms are not provided to the subcontractor operating under Option 1, the subcontractor must collect and remit sales tax on the charge for the separately stated building materials portion of the invoice. If the Option 1 subcontractor does not separately state the charge for the building materials from contractor labor, then the entire charge is taxable to the prime contractor.

Contractors operating under Option 2 (maintaining a tax-paid inventory) who have been issued a Form 17 from a governmental unit or an exempt organization, must furnish each vendor a copy of the Form 17 and a Form 13, completing Section C, Part 2, when purchasing building materials that will be annexed to real estate. Forms 13 and 17 must be retained with the vendor’s and contractor’s records for audit purposes. A contractor or subcontractor may reproduce copies of these documents which will be furnished to the vendors for each invoice or order made by them.

Invoices from vendors for the purchase of building materials by the contractor as purchasing agent, or the authorized subcontractor, must clearly identify that such purchase is for the specific Form 17 project.

CREDIT/REFUND OF SALES AND USE TAX. A contractor or subcontractor who has been appointed as a purchasing agent before any materials are annexed, may withdraw sales or use tax-paid materials from inventory that will be annexed to real estate or used to repair property annexed to real estate and receive a credit for the sales or use tax amount previously paid on those materials.

The contractor or subcontractor may take a credit either against his or her current tax liability, or file a [Claim for Overpayment of Sales and Use Tax, Form 7](#), and receive a refund of the sales or use tax paid on those materials.

TOOLS, EQUIPMENT, AND SUPPLIES. The purchase, rental, or lease of tools, supplies, or equipment (i.e., scaffolding, barricades, machinery, etc.) by a contractor for use in the completion of an exempt project CANNOT be purchased tax free, even if the contractor has been issued a Form 17. These items do not become annexed to the real estate.

OPTION 1 CONTRACTOR ONLY. If an Option 1 contractor is the **only** contractor involved in performing work for a governmental unit or exempt organization, a Form 17 is NOT required. The Option 1 contractor must only obtain a Form 13, Section B, from the exempt project owner.

PENALTY. Any person who signs this document with the intent to evade payment of tax is liable for the sales and use tax, interest, and penalty, and may be found guilty of a misdemeanor.

AUTHORIZED SIGNATURE. The purchasing agent appointment must be signed by an officer of the exempt organization or proper government official. The delegation of prime contractor’s authority must be signed by the owner, partner, corporate officer, or other individual authorized to sign by a power of attorney on file with the Nebraska Department of Revenue.

CONTRACT AGREEMENT

CONTRACT AGREEMENT

THIS AGREEMENT made and entered into this ____ day of _____, **2023**, by and between _____, hereinafter called the Contractor, and the City of Grand Island, Nebraska, hereinafter called the City.

WITNESSETH:

THAT, WHEREAS, in accordance with law, the City has caused contract documents to be prepared and an advertisement calling for bids to be published, for construction of **18th Street- Moores Creek Drainway to Diers Avenue; Project No. 2022-P-8**; and

WHEREAS, the City, in the manner prescribed by law, has publicly opened, examined, and canvassed the proposals submitted, and has determined the aforesaid Contractor to be the lowest responsive bidder, and has duly awarded to the said Contractor a contract therefore, for the sum or sums named in the Contractor's bid, a copy thereof being attached to and made a part of this contract;

NOW, THEREFORE, in consideration of the compensation to be paid to the Contractor and of the mutual agreements herein contained, the parties have agreed and hereby agree, the City for itself and its successors, and the Contractor for itself or themselves, and its or their successors, as follows:

ARTICLE I. That the Contractor shall (a) furnish all tools, equipment, superintendence, transportation, and other construction materials, services and facilities; (b) furnish, as agent for the City, all materials, supplies and equipment specified and required to be incorporated in and form a permanent part of the completed work; (c) provide and perform all necessary labor; and (d) in a good substantial and workmanlike manner and in accordance with the requirements, stipulations, provisions, and conditions of the contract documents as listed in the attached General Specifications and Special Provisions, said documents forming the contract and being as fully a part thereof as if repeated verbatim herein, perform, execute, construct and complete all work included in and covered by the City's official award of this contract to the said Contractor, such award being based on the acceptance by the City of the Contractor's bid;

ARTICLE II. That the City shall pay to the contractor for the performance of the work embraced in this contract and the contractor will accept as full compensation therefore the sum (subject to adjustment as provided by the contract) of _____ **AND XX/100 DOLLARS (\$_____)** for all services, materials, and work covered by and included in the contract award and designated in the foregoing Article I; payments thereof to be made in cash or its equivalent in the manner provided in the General Specifications.

ARTICLE III. The contractor hereby agrees to act as agent for the City in purchasing materials and supplies for the City for incorporation into the work of this project. The City shall be obligated to the vendor of the materials and supplies for the purchase price, but the contractor shall handle all payments hereunder on behalf of the City. The vendor shall make demand or claim for payment of the purchase price from the City by submitting an invoice to the contractor. Title to all materials and supplies purchased hereunder shall vest in the City directly from the vendor. Regardless of the method of payment, title shall vest immediately in the City. The contractor shall not acquire title to any materials and supplies incorporated into the project. All invoices shall bear the contractor's name as agent for the City. This paragraph will apply only to these materials and supplies actually incorporated into and becoming a part of the finished product of **18th Street- Moores Creek Drainway to Diers Avenue; Project No. 2022-P-8**.

ARTICLE IV. All contact work shall be substantially completed by **September 1, 2023** and ready for final acceptance by **November 30, 2023**. Substantially complete is defined that all pavements including driveways, sidewalks, and striping is completed and open to traffic. Final acceptance is defined that all items are complete for the project including any final punch list items and establishment of all seeded areas.

ARTICLE V. It is understood and agreed that time is the essence of the contract. Should the Contractor fail to perform all of the work within the overall period of time stipulated in the Contract Agreement, the Contractor shall pay to the City, as liquidated damages and not as a penalty, **\$350.00** per **calendar** day of default unless extensions of time granted by the City specifically provide for the waiving of liquidated damages.

The City shall have the right to deduct the liquidated damages from any moneys in its hands, otherwise due, or to become due, to the Contractor, or to use for and recover compensation for damages for non-performance of this contract within the time stipulated.

ARTICLE VI. The Contractor agrees to comply with all applicable State fair labor standards in the execution of this contract as required by Section 73-102, R.R.S. 1943. The Contractor further agrees to comply with the provisions of Section 48-657, R.R.S. 1943, pertaining to contributions to the Unemployment Compensation Fund of the State of Nebraska. During the performance of this contract, the contractor and all subcontractors agree not to discriminate in hiring or any other employment practice on the basis of race, color, religion, sex, national origin, age or disability. The Contractor agrees to comply with all applicable Local, State and Federal rules and regulations.

ARTICLE VII. GRATUITIES AND KICKBACKS: City Code states that it is unethical for any person to offer, give, or agree to give any City employee or former City employee, or for any City employee or former City employee to solicit, demand, accept, or agree to accept from another person, a gratuity or an offer of employment in connection with any decision, approval, disapproval, recommendation, or preparation of any part of a program requirement or a purchase request, influencing the content of any specification or procurement standard, rendering of advice, investigation, auditing, or in any other advisory capacity in any proceeding or application, request for ruling, determination, claim or controversy, or other particular matter, pertaining to any program requirement or a contract or subcontract, or to any solicitation or proposal therefore. It shall be unethical for any payment, gratuity, or offer of employment to be made by or on behalf of a subcontractor under a contract to the prime contractor or higher tier subcontractor or any person associated therewith, as an inducement for the award of a subcontract to order.

ARTICLE VIII. The City of Grand Island, Nebraska operates on a fiscal year beginning October 1st and ending on the following September 30th. It is understood and agreed that any portion of this agreement which will be performed in a future fiscal year is contingent upon the City Council adopting budget statements and appropriations sufficient to fund such performance.

ARTICLE IX. FAIR EMPLOYMENT PRACTICES: Each proposer agrees that they will not discriminate against any employee or applicant for employment because of age, race, color, religious creed, ancestry, handicap, sex or political affiliation.

ARTICLE X. LB 403: Every public contractor and his, her or its subcontractors who are awarded an agreement by the City for the physical performance of services within the State of Nebraska shall register with and use a federal immigration verification system to determine the work eligibility status of new employees physically performing services within the State of Nebraska.

IN WITNESS WHEREOF, the parties hereto have executed this Contract Agreement as of the date and year first above written.

CONTRACTOR

By _____

Date _____

Title _____

CITY OF GRAND ISLAND, NEBRASKA,

By _____
Mayor

Date _____

Attest: _____
City Clerk

The contract and bond are in due form according to law and are hereby approved.

Attorney for the City

Date _____

APPENDIX A – TITLE VI NON-DISCRIMINATION -

During the performance of this contract, the contractor, for itself, its assignees and successors in interest (hereinafter referred to as the "contractor") agrees as follows:

- (1) **Compliance with Regulations:** The contractor shall comply with the Regulation relative to nondiscrimination in Federally-assisted programs of the Department of Transportation (hereinafter, "DOT") Title 49, Code of Federal Regulations, Part 21, and the Federal Highway Administration (hereinafter "FHWA") Title 23, Code of Federal Regulations, Part 200 as they may be amended from time to time, (hereinafter referred to as the Regulations), which are herein incorporated by reference and made a part of this contract.
- (2) **Nondiscrimination:** The Contractor, with regard to the work performed by it during the contract, shall not discriminate on the grounds of race, color, or national origin, sex, age, and disability/handicap in the selection and retention of subcontractors, including procurements of materials and leases of equipment. The contractor shall not participate either directly or indirectly in the discrimination prohibited by 49 CFR, section 21.5 of the Regulations, including employment practices when the contract covers a program set forth in Appendix B of the Regulations.
- (3) **Solicitations for Subcontractors, Including Procurements of Materials and Equipment:** In all solicitations either by competitive bidding or negotiation made by the contractor for work to be performed under a subcontract, including procurements of materials or leases of equipment, each potential subcontractor or supplier shall be notified by the contractor of the contractor's obligations under this contract and the Regulations relative to nondiscrimination on the grounds of race, color, or national origin, sex, age, and disability/handicap.
- (4) **Information and Reports:** The contractor shall provide all information and reports required by the Regulations or directives issued pursuant thereto, and shall permit access to its books, records, accounts, other sources of information, and its facilities as may be determined by the City of Grand Island or the FHWA to be pertinent to ascertain compliance with such Regulations, orders and instructions. Where any information required of a contractor is in the exclusive possession of another who fails or refuses to furnish this information the contractor shall so certify to the City of Grand Island, or the FHWA as appropriate, and shall set forth what efforts it has made to obtain the information.
- (5) **Sanctions for Noncompliance:** In the event of the contractor's noncompliance with the nondiscrimination provisions of this contract, the City of Grand Island shall impose such contract sanctions as it or the FHWA may determine to be appropriate, including, but not limited to:
 - (a.) withholding of payments to the contractor under the contract until the contractor complies, and/or
 - (b.) cancellation, termination or suspension of the contract, in whole or in part.
- (6) **Incorporation of Provisions:** The contractor shall include the provisions of paragraphs (1) through (6) in every subcontract, including procurements of materials and leases of equipment, unless exempt by the Regulations, or directives issued pursuant thereto.

The contractor shall take such action with respect to any subcontract or procurement as the City of Grand Island or the FHWA may direct as a means of enforcing such provisions including sanctions for non-compliance: Provided, however, that, in the event a contractor becomes involved in, or is threatened with, litigation with a subcontractor or supplier as a result of such direction, the contractor may request the City of Grand Island to enter into such litigation to protect the interests of the City of Grand Island, and, in addition, the contractor may request the United States to enter into such litigation to protect the interests of the United States.

DIVISION I

GENERAL SPECIFICATIONS

**APPLICABLE TO ALL
CONSTRUCTION CONTRACTS**

**DIVISION I
GENERAL SPECIFICATIONS**

C O N T E N T S

| Section | Description |
|----------|--|
| 1 | DEFINITIONS OF WORDS AND TERMS |
| 1.01 | Abbreviations |
| 1.02 | Advertisement |
| 1.03 | Award |
| 1.04 | Backslope |
| 1.05 | Bidder |
| 1.06 | Calendar Day |
| 1.07 | Change Order |
| 1.08 | City |
| 1.09 | Contract |
| 1.10 | Contract or Performance Bond |
| 1.11 | Contract Item |
| 1.12 | Contract Period |
| 1.13 | Contractor |
| 1.14 | Cul-de-sac Street |
| 1.15 | Culvert |
| 1.16 | Easement (Right-of-way) |
| 1.17 | Employee |
| 1.18 | Engineer |
| 1.19 | Extra Work |
| 1.20 | Holidays |
| 1.21 | Inspector |
| 1.22 | Laboratory |
| 1.23 | Notice to Bidders |
| 1.24 | Plans |
| 1.25 | Project |
| 1.26 | Bid |
| 1.27 | Bid Form |
| 1.28 | Bid Guarantee |
| 1.29 | Right-of-way |
| 1.30 | Special Provisions |
| 1.31 | Specifications |
| 1.32 | Subcontractor |
| 1.33 | Superintendent |
| 1.34 | Supplemental Agreements |
| 1.35 | Supplemental Specifications |
| 1.36 | Surety |
| 1.37 | Work |
| 1.38 | Working Day |
| 1.39 | Working Drawings |
| 1.40 | Work Order |
| 1.41 | Completion of the Work and Formal Acceptance by the City |
| 1.42 | Final Acceptance of the Work |

Revised 1-25-2011

| Section | Description |
|----------|--|
| 2 | BID REQUIREMENTS AND CONDITIONS |
| 2.01 | Contents of Bid Forms |
| 2.02 | Interpretation of Quantities in Bid Forms |
| 2.03 | Examination of Plans, Specifications, Special Provisions and Site of Work |
| 2.04 | Preparation of Bid |
| 2.05 | Statement of Bidder's Plant and Financial Conditions |
| 2.06 | Certified, Check, Cashier's Check, or Bid Bond |
| 2.07 | Filing of Bid |
| 2.08 | Withdrawal of Bid |
| 2.09 | Public Opening of Bids |
| 2.10 | Material Guarantee |
| 3 | AWARD AND EXECUTION OF THE CONTRACT |
| 3.01 | Consideration of Bids |
| 3.02 | Award of Contract |
| 3.03 | Cancellation of Award |
| 3.04 | Return of Bid Guarantee |
| 3.05 | Performance Bond |
| 3.06 | Contract Documents |
| | Revised 1-25-2011 |
| 3.07 | Failure to Execute Contract |
| 4 | SCOPE OF WORK |
| 4.01 | Intent of Plans and Specifications |
| 4.02 | Special Work |
| 4.03 | Increased or Decreased Quantities of Work |
| | Revised 1-25-2011 |
| 4.04 | Extra Work |
| 4.05 | Maintenance of Detours |
| 4.06 | Temporary Traffic Control |
| | Revised 1-25-2011 |
| 4.07 | Maintenance of Traffic |
| 4.08 | Street Closing |
| 4.09 | Miscellaneous Removal Items |
| 4.10 | Removal and Replacement of Property Stakes |
| 4.11 | Removal and Disposal of Structures and Obstructions |
| 4.12 | Rights In and Use of Materials Found on the Right-of-Way |
| 4.13 | Construction and Demolition Debris |
| 4.14 | Final Cleaning Up |
| 4.15 | Right-of-way |
| 4.16 | Railroad Crossings |
| 4.17 | Safety and Health Regulations for Constructions |
| 5 | CONTROL OF WORK |
| 5.01 | Authority of Engineer |
| 5.02 | Plans and Working Drawings |
| 5.03 | Alteration of Plans or of Character of Work |
| 5.04 | Coordination of Plans, Specifications, Special Provisions, and Supplemental Specifications |
| 5.05 | Cooperation of Contractor |

| Section | Description |
|----------|---|
| 5.06 | Surveys |
| 5.07 | Authority and Duties of Inspector |
| 5.08 | Inspection of Work |
| 5.09 | Removal of Defective Work |
| 5.10 | Final Inspection |
| 6 | CONTROL OF MATERIALS |
| 6.01 | Source of Supply and Quality Requirements |
| 6.02 | Methods of Sampling and Testing, and Cited Specifications |
| 6.03 | Storage of Materials |
| 6.04 | Unacceptable Materials |
| 6.05 | Guarantee |
| 6.06 | "Or Equal" Clause |
| 7 | LEGAL RELATIONS AND RESPONSIBILITY TO THE PUBLIC |
| 7.01 | Laws to be Observed |
| 7.02 | State and City Fair Labor Standards |
| 7.03 | Anti-discrimination |
| 7.04 | Permits |
| 7.05 | Patents |
| 7.06 | Restoration of Surface Opened by Permit |
| 7.07 | Safety, Health, and Sanitation |
| 7.08 | Barricades and Warning Signs |
| 7.09 | Use of Explosives |
| 7.10 | Claims for Labor and Materials |
| 7.11 | Contractor's Insurance |
| 7.12 | Proof of Carriage of Insurance |
| 7.13 | Contractor's Responsibility for Utility Property and Services |
| 7.14 | No Waiver of Legal Rights |
| 7.15 | Exposure of Pipe or Manholes |
| 8 | PROSECUTION AND PROGRESS |
| 8.01 | Subletting or Assigning of Contract |
| 8.02 | Prosecution of Work |
| 8.03 | Limitations of Operations |
| 8.04 | Methods and Equipment |
| 8.05 | Temporary Suspension of Work |
| 8.06 | Liquidated Damages |
| 8.07 | Extension of Contract Period |
| 8.08 | Abrogation |
| 8.09 | Termination of Contractor's Responsibility |
| 9 | MEASUREMENT AND PAYMENT |
| 9.01 | Payments |
| 9.02 | Payments Withheld |
| 9.03 | Acceptance and Final Payment |
| 9.04 | Payment for Extra Work |

**DIVISION I
GENERAL SPECIFICATIONS**

SECTION 1 - DEFINITIONS OF WORDS AND TERMS

Wherever in these specifications or in other contract documents the following terms or pronouns in place of them are used, the intent and meaning shall be interpreted as follows:

1.01 Abbreviations.

| | |
|--------|---|
| AASHTO | American Association of State Highway And Transportation Officials |
| ASTM | American Society for Testing and Materials |
| ANSI | American National Standards Institute |
| AWWA | American Water Works Association |
| AREA | American Railway Engineering Association |
| AWS | American Welding Society |
| AAN | American Association of Nurserymen |

1.02 Advertisement. The advertisement for work or materials on which bids are to be received.

1.03 Award. The decision of the City to accept the bid of the lowest responsible bidder for the work, subject to the execution and approval of a satisfactory contract therefor and bond to secure the performance thereof and to such other conditions as may be specified or otherwise required by law.

1.04 Backslope. The sloping surface of a cut, the downward inclination of which is toward the roadbed.

1.05 Bidder. Any individual, firm, or corporation formally submitting a bid for the work contemplated, acting directly or through a duly authorized representative.

1.06 Calendar Day. Every day shown on the calendar, Sundays and holidays included.

1.07 Change Order. A written order to the Contractor, signed by the Engineer, ordering a change in the work from that originally shown in the plans and specifications.

1.08 City. The word "City" as used in these specifications refers to the City of Grand Island, Nebraska, acting through its City Council.

1.09 Contract. The written agreement executed between the City and the Contractor, covering the performance of the work and the furnishing of labor and materials, by which the Contractor is bound to perform the work and furnish the labor and materials, and by which the City is obligated to compensate Contractor therefor at the mutually established and accepted rate or price.

The contract shall include the "Notice to Bidders", these specifications, the Contractor's bond, the general and detailed plans, the bid, special provisions, and supplemental agreements.

1.10 Contract or Performance Bond. The approved form of security, executed by the Contractor and their surety or sureties, guaranteeing complete execution of the contract and all supplemental agreements pertaining thereto and the payment of all legal debts pertaining to the construction of the project.

1.11 Contract Item. An item of work specifically described and for which a price, either unit or lump sum, is provided. It includes the performance of all work and the furnishing of all labor, equipment, and materials described in the text of a specification item included in the contract or described in any subdivision of the text of the supplemental specification or special provision of the contract.

1.12 Contract Period. The period from the date specified in the contract for the commencement of the work to the date specified for its completion, both dates inclusive.

1.13 Contractor. The party of the second part to the contract; the individual, firm, or corporation undertaking the execution of the work under the terms of the contract and acting directly or through Contractor's agents or authorized employees.

1.14 Cul-de-sac Street. A local street open at one end only and with special provision for turning around.

1.15 Culvert. Any structure not classified as a bridge which provides an opening under any street.

1.16 Easement (Right-of-way). A right acquired by public authority to use or control property for a designated purpose.

1.17 Employee. Any person working on the project mentioned in the contract of which these specifications are a part, and who is under the direction or control or receives compensation from the Contractor or Contractor's subcontractor.

1.18 Engineer. The City Engineer, acting either directly or through an assistant or other representative duly authorized by the City Engineer, such assistant or representative acting within the scope of the particular duties assigned or with the authority given.

1.19 Extra Work. Work performed by the Contractor in order to complete the contract in an acceptable manner but for which there is no basis of payment provided in the contract.

1.20 Holidays. In the State of Nebraska, holidays occur on: January 1, Martin Luther King, Jr. Day in January, Presidents' Day in February, Arbor Day in April, Memorial Day in May, July 4, Labor Day in September, Columbus Day in October, Veterans Day and Thanksgiving Day in November, and December 25. If any of said dates fall on Sunday, the following Monday shall be a holiday. If any of said dates fall on Saturday, the previous Friday shall be a holiday.

1.21 Inspector. An authorized representative of the Engineer assigned to make detailed inspection of any or all portions of the work performed and materials furnished by the Contractor.

1.22 Laboratory. The testing laboratory of the City or any other testing laboratory which may be designated by the Engineer.

- 1.23 Notice to Bidders. The provisions, requirements, and instructions pertaining to the work to be awarded, manner and time of submitting bids , quantities of the major items or work required, as prepared for the information of bidders.
- 1.24 Plans. The official plans, profiles, typical cross sections, general cross sections, working drawings, and supplemental drawings, or exact reproductions thereof, approved by the Engineer, which show the location, character, dimensions, and details of the work to be done, and which are to be considered as a part of the contract supplementary to these specifications.
- 1.25 Project. All work necessary to be performed under the contract.
- 1.26 Bid. The offer of the bidder, submitted on the prescribed bid form, to perform the work and to furnish the labor and materials at the prices quoted by the bidder.
- 1.27 Bid Form. The approved form on which the City requires formal bids be prepared and submitted.
- 1.28 Bid Guarantee. The security furnished by the Bidder with Bidder's bid for a project as a guarantee that Bidder will enter into a contract for the work if said bid is accepted.
- 1.29 Right-of-way. The land area which is reserved or secured by the City for constructing the work or for obtaining material therefor.
- 1.30 Special Provisions. Special directions, provisions, or requirements peculiar to the project under consideration and not otherwise thoroughly or satisfactorily detailed or set forth in the specifications.
- 1.31 Specifications. The general term comprising all the directions, provisions, and requirements contained herein, together with such as may be added or adopted as supplemental specifications or special provisions, all of which are necessary for the proper performance of the contract.
- 1.32 Subcontractor. Any individual, firm, or corporation to whom the Contractor, with the written consent of the City, sublets any part of the contract.
- 1.33 Superintendent. The representative of the Contractor, present on the work at all times during progress, authorized to receive and fulfill instructions from the Engineer and capable of superintending the work efficiently.
- 1.34 Supplemental Agreements. Written agreements executed by the Contractor and the City subsequent to having entered into the contract, covering alterations in the plans or unforeseen items of construction.
- 1.35 Supplemental Specifications. Specifications adopted subsequent to the publication of this book. They generally involve new construction items or substantial changes in the approved specifications. Supplemental specifications shall prevail over those published in this book whenever in conflict therewith.
- 1.36 Surety. The corporate body bound with and for the Contractor for the acceptable performance of the contract, the completion of the work, and for payment of all just claims arising therefrom.

1.37 Work. Work shall be understood to mean the furnishing of all labor, materials, equipment, and other incidentals necessary or convenient to the successful completion of the project by the Contractor and the carrying out of all the duties and obligations imposed by the contract.

1.38 Working Day. Any day, except Saturdays, Sundays, and Nebraska holidays, on which the Contractor is not prevented by weather, soil conditions, or other conditions beyond the Contractor's control, adverse to the current controlling operation or operations, as determined by the Engineer, from proceeding with at least 80 percent of the labor and equipment force normally engaged in such operation or operations for at least 50 percent of the full number of hours in Contractor's normal daily schedule. Also, a Saturday, Sunday, or Nebraska holiday on which any work is performed on the current controlling operation or operations unless the Contractor is prevented by weather, soil conditions, or other conditions beyond the Contractor's control as determined by the Engineer, from proceeding for at least 50 percent of the full number of hours in their normal schedule with 80 percent of the normal working force.

1.39 Working Drawings. Stress sheets, shop drawings, erection plans, falsework plans, framework plans, cofferdam plans, bending diagrams for reinforcing steel, or any other supplementary plans for similar data which the Contractor is required to submit to the Engineer for approval.

1.40 Work Order. A written order signed by the Engineer, of a contractual status requiring performance by the Contractor without negotiation of any sort and may involve starting, resuming, or the suspension of work. (Not to be confused with extra work order).

1.41 Completion of the Work and Formal Acceptance by the City. Whenever the term "completion of the work and formal acceptance by the City" is used, it refers to and means the formal acceptance of the work by the Engineer and the City at the time the Contractor has all work under the contract completed and in place.

1.42 Final Acceptance of the Work. Whenever the term "final acceptance of the work" is used, it refers to and means the time when the Engineer and the City finally accept the work. The contractor guarantee shall remain in force from the City's final acceptance for a period of one year.

Revised 1-25-2011

SECTION 2 – BID REQUIREMENTS AND CONDITIONS

2.01 Contents of Bid Forms. Bidders will be furnished with bid forms which will state the location and description of the contemplated work and will show the estimate of the various quantities and kinds of work to be performed or materials to be furnished, with a schedule of items for which unit bid prices are asked, the time in which the work must be completed and the date, time, and place of opening bids. All special provisions and required provisions will be grouped together and bound with or included through reference in the bid form.

2.02 Interpretation of Quantities in Bid Forms. The quantities listed in the bid forms are to be considered as approximate, unless otherwise provided by special provision. It is understood that the quantities of work to be done and materials to be furnished may each be increased, diminished, or omitted as hereinafter provided without in any way invalidating the unit bid prices, except as provided in the section in these specifications entitled Increased or Decreased Quantities of Work.

2.03 Examination of Plans, Specifications, Special Provisions, and Site of Work. The bidder is required to examine carefully the site, the bid, plans, specifications, special provisions, and contract form for the work contemplated, and it will be assumed that the bidder has investigated and is satisfied as to the conditions to be encountered, as to the character, quality, and quantities of work to be performed and materials to be furnished and as to the requirements of these specifications, the special provisions, and contract. It is mutually agreed that the submission of a bid shall be considered prima facie evidence that the bidder has made such examination.

2.04 Preparation of Bid. Bidders shall submit their bids on blank forms furnished by the Engineer with the full name and address and the place of business or residence of the bidder. If the bidder is co-partnership, the signature shall be by a member of the firm with the names and addresses of each member. If the bidder is a corporation, the signature shall be by an officer of the corporation in the corporate name and with the corporate name and the corporate seal attached thereto.

All blank spaces in the form shall be fully filled; numbers shall be stated in legible figures and writing when required; the signature shall be longhand; and the complete form shall be without interlineation, alteration, or erasure.

No oral, telegraphic, or telephonic bids or modifications will be considered.

When certain alternative prices, for both increasing and decreasing the cost, are required, as called for in the bid sheet, it must be understood that all materials and workmanship required shall be the best of their respective kinds and in all cases shall correspond with similar work herein specified and, if accepted, the work shall be done under the general terms of the specifications.

2.05 Statement of Bidder's Plant and Financial Conditions. Each bidder may submit with bid and, in any event, the City may, after bids are opened and prior to award of contract, require any bidder to submit the following data:

1. A statement that the bidder maintains a permanent place of business and address thereof;
2. A statement of equipment which the bidder proposes to use on the project, together with a statement noting that equipment previously mentioned which the bidder owns and that which bidder does not own but is certain bidder will be able to rent or otherwise procure for use on the project;
3. A financial statement, duly sworn to in a form approved by the City, listing assets and liabilities;
4. Statement listing projects of similar nature which the bidder has constructed or in the construction of which the bidder was actively engaged in a responsible capacity. Any bidder may be required by the City to submit additional data to satisfy the City that such bidder is prepared to fulfill the contract if it is awarded to them.

2.06 Certified Check, Cashier's Check, or Bid Bond. Each bidder must submit with the bid a certified check, cashier's check, or bid bond in the amount of not less than five percent (5%) of the amount bid, drawn to the order of the City Treasurer, Grand Island, Nebraska, guaranteeing the execution of the contract and bond required within ten (10) days of the notification of award. Any certified check must be issued by a bank in the State of Nebraska.

2.07 Filing of Bid. Bidders shall submit bid data on items offered in the Bid by filling in one set of data sheets supplied by the Engineering Department. The bid sheets shall be filled out legibly in black ink to permit reproduction.

Bidder security, when required, shall be enclosed in a special envelope marked, "BIDDER SECURITY/BID FOR _____." The envelope shall contain only a cashier's check or bidder's bond. This special envelope shall be attached to a sealed envelope containing the bid, filled out specifications, descriptive information drawings, qualification list and any other bid materials. This second envelope shall be marked "BID FOR _____." Bids of an incomplete nature or subject to multiple interpretations may, at the option of the Purchaser, be rejected as being irregular.

All bids shall be filed with the City at the place designated in the Notice to Bidders, prior to the time advertised for the opening of bids.

2.08 Withdrawal of Bid. A bidder will be permitted to withdraw said bid unopened after it has been submitted, if bidder's request for withdrawal is made in writing and delivered personally by the bidder or bidders' authorized representative prior to the time specified for opening of bids.

2.09 Public Opening of Bids. Bids will be publicly opened and read at the time and place stipulated in the Notice to Bidders.

2.10 Material Guarantee. Before any contract is awarded, the bidder may be required to furnish a complete statement of the origin, composition, and manufacture of any or all materials to be used in the construction of the work together with samples, which samples may be subjected to the test provided for in these specifications to determine their quality and fitness for the work.

SECTION 3 - AWARD AND EXECUTION OF THE CONTRACT

3.01 Consideration of Bids. After the bids are opened and read, they will be compared on the basis of the summation of the products and the quantities shown in the bid schedule by the unit bid prices. The results of such comparisons will be immediately available to the public.

The right is reserved to reject any and all bids and to waive technical errors as may be deemed best for the interest of the City.

3.02 Award of Contract. In the award of contract, consideration will be given not only to the prices bid but also the mechanical and other equipment available to the bidder, the financial responsibility of the bidder, and bidder's ability and experience in the performance of like or similar contracts.

Award of contracts will be made as promptly as practical after bids have been opened and read. The City reserves the right to delay the award for such time as is needed for the consideration of the bids and for the receipt of concurrence in recommended contract awards from other governmental agencies whose concurrence may be required.

3.03 Cancellation of Award. The City reserves the right to cancel the award of any contract at any time before execution of the said contract by all parties without any liability against the City.

3.04 Return of Bid Guarantee. Bid guaranties will be returned to the unsuccessful bidders by mail promptly after the signing of the contract has been made. Return to the successful bidder will be made after the signing of the contract and filing of the contract bond.

3.05 Performance Bond. The Contractor shall furnish a performance bond with a company having the approval of the City in an amount of 100 percent of the contract price guaranteeing complete and faithful performance of the contract, payment of all bills of whatever nature which could become a lien against the property, and guaranteeing replacement of defective materials and workmanship for a period of one year after completion of the contract.

3.06 Contract Documents. Three (3) copies of Contract Documents shall be made, executed, and distributed as follows:

One copy to City Clerk
One copy to Contractor One copy to Engineer

The following documents are a part of the contract:

| | |
|--------------------------|--|
| *Notice to Bidders | *General Specifications |
| *Instructions to Bidders | *Special Provisions |
| *Bid | *Supplemental Specifications |
| *Detailed Specifications | *Performance Bond |
| *Contract | *Additional Drawings as required to make clear the intent of the contract |

Revised 1-25-2011

3.07 Failure to Execute Contract. Failure to execute a contract and file an acceptable performance bond as provided herein within ten (10) days from date of award shall be just cause for the annulment of the award and the forfeiture of the certified check or cashier's check to the City, not as a penalty but in liquidation of damages sustained.

SECTION 4 - SCOPE OF WORK

4.01 Intent of Plans and Specifications. The intent of the plans and specifications is to provide for the construction and completion of every detail of the work described therein. It shall be understood by the Contractor that Contractor will furnish all labor, materials, tools, transportation, and supplies required for all or any part of the work to make each item complete in accordance with the spirit of the contract. It is understood that the apparent silence of the specifications as to any detail or the apparent omission of a detailed description concerning any point shall be regarded as meaning that only the best general practice is to prevail and that only materials and workmanship of the first quality are to be used.

For the purpose of design and the preparation of the Engineer's Estimate, the City may perform a reasonable amount of exploratory work to gain information relative to surface and subsurface conditions relating to type of soil, moisture content, and types and extent of rock strata.

This information when shown on the plan represents to the best of the City's knowledge conditions as of the date the survey was made. The appearance of this information on the plan will not constitute a guarantee that conditions other than those indicated will not be encountered at the time of construction.

The bidder may utilize this information as they see fit. Any bidder interested in the work is authorized to make whatever investigation they considers advisable.

In making such additional investigation, the bidder is directed to the Engineer for information relating to available right-of-way. If there are, at that time, any parcels of land over which the City does not have jurisdiction, right of entry must be secured by the prospective bidder from those authorized to grant such permission. Investigational work, performed by a prospective bidder on existing streets open to traffic, shall be performed in compliance with the

requirements of the current Manual on Uniform Control Devices for Street and Highways. All such additional investigational work shall be performed without costing or obligating the City in any way.

4.02 Special Work. Any conditions not covered by these standard specifications are stated in the special provisions.

4.03 Increased or Decreased Quantities of Work. The Engineer reserves the right to alter the quantities of contract items for which there are bid prices. Such increases or decreases in quantities shall be made as the City considers necessary or desirable without waiving or invalidating any of the provisions of the contract. All such alterations must be ordered in writing and a supplemental agreement must be executed with the Contractor for the item or items involved when such alterations involve an increase or decrease of more than 20 percent of the total cost of the work of any group of the contract calculated from the original bid quantities and the contract unit prices. The Contractor shall not start work on any alteration requiring a supplemental agreement until the agreement setting forth an equitable adjustment of compensation, satisfactory to both parties, shall have been executed by the Engineer and the Contractor and approved by City Council.

Revised 1-25-2011

4.04 Extra Work. The City reserves the right to order the performance of work of a class not contemplated in the bid but which may be considered necessary to complete satisfactorily the work included in the contract. Such extra work will be paid for as provided in these specifications under section entitled Payment for Extra Work.

4.05 Maintenance of Detours. Unless so required by the plans or the special provisions, the Contractor will not be required to assume any responsibility in connection with the maintenance or marking of suitable detours.

4.06 Temporary Traffic Control. Part VI of the Manual of Uniform Traffic Control Devices (MUTCD) is the national standard for work zone traffic control. The current version that has been adopted by the Nebraska Department of Roads is also applicable to the City of Grand Island and shall be followed.

Any City crews, contractors, utility company, or any other person, firm or corporation performing work within the right-of-way of any public street, public way, or alley in the City of Grand Island shall install and maintain Temporary Traffic Control (TTC) in accordance with the standards of the MUTCD.

The Public Works Director or their representative shall have the authority to direct corrective actions for any TTC not in compliance with the MUTCD and these provisions. These actions may include suspending operations and requiring removal of all equipment or materials from the right-of-way.

If the TTC is left in place longer than four (4) hours and no personnel are on the site, the individual responsible for installing the TTC shall provide telephone numbers of personnel who will be available on a 24 hours per day, seven days per week basis to the Public Works Director. These individuals shall be responsible for repair, correction, replacement and maintenance of the traffic control devices. These individuals shall perform inspections of the TTC at the site a minimum of twice during the day and once during the night every day until the work is completed and the right-of-way is cleared.

Subsidiary: Unless contract pay items are included with the bid specifications, direct payment for providing, installing, maintaining, and performing site inspections of TTC devices will not be made but are considered subsidiary to other items for which direct payment is

provided. When the contract contains a pay item for TTC, the NDOR standard items, specifications, etc. will be used.

Revised 1-25-2011

4.07 Maintenance of Traffic. The Contractor shall conduct the work so as to interfere as little as possible with public travel, whether vehicular or pedestrian. Whenever it is necessary to cross, obstruct, or close roads, driveways, and walks, whether public or private, the Contractor shall, at Contractor's expense, provide and maintain suitable and safe bridges, detours, or other temporary expedients for the accommodation of public and private travel, and shall give reasonable notice to owners of private drives before interfering with them. Such maintenance of travel will not be required when the Contractor has obtained permission from the owner or tenant of private property or from the authority having jurisdiction over public property involved to obstruct traffic at the designated area.

4.08 Street Closing. In the event it is deemed necessary for the Contractor to close any streets during the execution of said work, the Contractor shall notify the owner of such street closing 72 hours in advance, prior to any street closing due to open cut street crossing.

4.09 Miscellaneous Removal Items. The Contractor shall inform the Engineer sufficiently ahead of construction so landowners can be notified to remove small trees, shrubs, and fences from the construction limits if the landowners desire to save them.

4.10 Removal and Replacement of Property Stakes. If it is necessary to remove any property corners or markers during construction operations, the Contractor shall notify the Engineer so the Engineer can establish reference ties. Any markers removed without notice to the Engineer shall be replaced at the Contractor's expense in accordance with the proper land surveying techniques.

4.11 Removal and Disposal of Structures and Obstructions. The Contractor for bridge and culvert work shall remove any existing structure or part of structure that in any way interferes with the new construction. If specific payment for such work has not been provided in the contract, it will be paid for as extra work.

The Contractor shall remove any materials or structures found on the right-of-way which are not to remain in place or which have not been designated for use in the new construction. The removal and disposal of pipe culverts will not be paid for directly but shall be considered as incidental work, and the cost of such removal and disposal shall be considered to be included in the contract price for other items. Pipe culverts shall be removed by methods that will cause a minimum of damage to the pipe culverts. The removal and disposal of bridges or other masonry or monolithic concrete construction will be paid for. If the contract does not contain an item for such work, it will be paid for as extra work.

4.12 Rights In and Use of Materials Found on the Right-of-way. Unless stated to the contrary in the contract documents, all materials, such as stone, gravel, sand, timber, and structures or parts of structures, found on the right-of-way of the street or on land acquired for the work, are the property of the City or the owner of the fee title to the land, and shall not be used or destroyed by the Contractor without special permission from the Engineer. When the Contractor is permitted to use materials found on the right-of-way, any excavations that they make below the grade elevation shall be backfilled with other suitable materials so the finished street will conform to the grade shown on the plans. No extra compensation will be allowed for such backfilling.

When rock excavation is encountered, any portion of rock excavation which would otherwise be deposited in waste areas and not be incorporated in the embankments may be processed and used, royalty free, by the Contractor in any other portion of the construction in which material of that quality would be acceptable. No deduction will be made from excavation quantities for rock so used.

4.13 Construction and Demolition Debris. Debris from any City awarded project, as well as Municipal Solid Waste (that is not recycled), shall be disposed of at the City's Solid Waste facilities.

4.14 Final Cleaning Up. Upon completion of the work and before acceptance and final payment, the Contractor shall clean the street, borrow pits, and all ground occupied by Contractor in connection with the work of all rubbish, excess materials, falsework, temporary structures, and equipment, and all parts of the work, shall be left in a neat and presentable condition.

When required in the plans, the Contractor shall, at Contractor's expense, replace waste material or stripping back into borrow and material pits as directed by the Engineer. Trees, tree stumps and material placed on property adjacent to the street during the execution of the work shall be disposed of by the Contractor.

4.15 Right-of-way. Right-of-way for the work will be provided without cost to the Contractor. Right-of-way will be made available to the Contractor on or before the date specified for the commencement of the work unless a later date for the right-of-way to be made available to the Contractor is designated in the contract documents.

4.16 Railroad Crossings. Whenever the work involves construction with which railroad companies are concerned, the performance of the work is contingent upon arrangements with the railroad companies for the proposed construction. No claims will be allowed for loss or damage caused by failure to complete such arrangements.

4.17 Safety and Health Regulations for Construction. Occupational Safety and Health Standards for the Construction Industry (29 CFR Part 1926) with amendments as of February 1, 1999 promulgated by the Occupational Safety and Health Administration, United States Department of Labor, Washington, D.C. are incorporated herein as a part of the contract documents.

SECTION 5 - CONTROL OF WORK

5.01 Authority of Engineer. The Engineer will have general supervision of the work and will decide any questions that arise with reference to the intent of the contract documents and compliance therewith. Said Engineer will relay all questions relating to materials, work, progress, disputes and mutual rights between contractors, fulfillment of contract, and compensation, in accordance with the provisions of these specifications.

5.02 Plans and Working Drawings. The approved plans will be supplemented by such working drawings as are necessary to adequately control the work. It is mutually agreed that all authorized alterations affecting the requirements and information given in the approved plans shall be in writing.

Working drawings for any structure shall consist of such detailed plans as may be required of the Contractor for the prosecution of the work. These are not included in the plans

furnished by the Engineer. They shall include shop details, erection plans, masonry, and form work. The Engineer's prior approval of the shop details must be obtained before any fabrication work involving these plans is performed. Erection plans, masonry layout diagrams, and plans for cribs, cofferdams, falsework, centering, and form work, as well as any other working drawings not previously mentioned, may be required of the Contractor and shall be subject to the Engineer's approval.

No changes shall be made in any plan or drawing after it has been approved except by consent or direction of the Engineer in writing. It is expressly understood that the approval by the Engineer of the Contractor's working drawings will not relieve the Contractor from any responsibility.

The contract price shall include the cost of furnishing all working drawings, and the Contractor will be allowed no extra compensation for such drawings.

Shop plans shall be made on 22"x36" sheet with ½" margin on all sides except the left which shall be 2". The margin lines shall measure 21"x33 ½". The marking shall be in accordance with the special plans or as may be required by the Engineer. All blueprint plans which are furnished to the Engineer shall be clear and distinct and acceptable to the Engineer and shall be neatly trimmed. The Contractor shall furnish the Engineer as many extra copies of working drawings as the Engineer may direct.

The Engineer may require reproducible prints of all approved shop plans, which shall be furnished by the Contractor without cost to the Engineer. Such reproducible prints shall not be folded but shall be mailed in tubes sized to accommodate these plans without injuring them. No preliminary working drawings will be accepted by the Engineer unless they have been carefully checked by the Contractor. Drawings showing gross errors will be returned for recheck before examination by the Engineer. The name of the shop or company furnishing the drawings shall be on the tracing.

5.03 Alteration of Plans or of Character of Work. The Engineer shall have the right to make alterations in plans or character of work as may be considered necessary or desirable during the progress of the work to satisfactorily complete the proposed construction. Such alterations shall not be considered as a waiver of any conditions of the contract or invalidate any of the provisions thereof.

5.04 Coordination of Plans, Specifications, Special Provisions, and Supplemental Specifications. These specifications, the supplemental specifications, the plans, special provisions, and all supplementary documents are essential parts of the contract, and a requirement occurring in one is as binding as though occurring in all. They are intended to be complementary and to describe and provide for a complete work. In case of discrepancy, figured dimensions shall govern over scaled dimensions, plans shall govern over specifications, special plans shall govern over standard plans, supplemental specifications shall govern over standard specifications, and special provisions shall govern over specifications, supplemental specifications, and the plans.

5.05 Cooperation of Contractor. The Contractor will be supplied with a minimum of two sets of approved plans and contract assemblies, including special provisions, one set of which the Contractor shall keep available on the work at all times.

The Contractor shall give the work the constant attention necessary to facilitate the progress thereof and shall cooperate with the Engineer and other contractors in every way possible.

The Contractor shall at all times have at the work site, as Contractor's agent, a competent superintendent capable of reading and thoroughly understanding the plans and specifications, thoroughly experienced in the type of work being performed, who shall receive

instructions from the Engineer or Engineer's authorized representatives. The superintendent shall have full authority to execute the orders or directions of the Engineer without delay, and to promptly supply materials, equipment, tools, labor, and incidentals as may be required. Such superintendence shall be furnished irrespective of the amount of work sublet.

5.06 Surveys. Lines and elevations shall be established by the Engineer before the work commences and the Contractor shall obtain lines and elevations from the points so set by the Engineer. The Contractor shall furnish all stakes necessary for lines and elevations and cooperate with the Engineer in setting same.

5.07 Authority and Duties of Inspector. The City may appoint inspectors to represent the Engineer in the inspection of all materials used in and all work done under the contract. Such inspection may extend to any part of the work and to the preparation or manufacture of the materials to be used. The inspector will not be permitted to modify in any way the provisions of the contract documents, nor to delay the work by failing to inspect materials and work with reasonable promptness. An inspector is placed at the work site to keep the Engineer informed as to its progress and the manner in which it is being done and to call the Contractor's attention to any infringements of the contract documents. The inspector will not act as foreman or perform other duties for the Contractor nor improperly interfere with the management of the work. They will not be authorized to approve or accept any portion of the work. In case of dispute between the Contractor and the inspector as to quality of materials or the manner of performing the work, the inspector shall have the authority to reject materials or suspend the work until the question at issue can be decided by the Engineer. Written notice of the suspension of work will be given to the Engineer and the Contractor.

5.08 Inspection of Work. The Contractor shall furnish the Engineer with every reasonable facility for ascertaining whether the work is being performed in conformance with the contract documents. At any time before acceptance of the work, upon request of the Engineer, the Contractor shall remove or uncover such portions of the finished work as the Engineer may direct. After examination has been made, the Contractor shall restore such portions of the work to the standard required by the contract documents.

If the work thus exposed or examined proves acceptable, the uncovering or removing and replacing of the covering or the restoring of the parts removed shall be paid for as extra work, except that no payment will be made for the work involved in checking the smoothness of pavement surfaces. If the work thus exposed and examined proves unacceptable, the Contractor shall replace the defective work in accordance with the specifications and will be paid only the contract price for the work as finally accepted. Work done or materials used without the Engineer having been afforded ample opportunity to provide suitable inspection may be ordered removed and replaced at the Contractor's expense or may be excluded from the quantities measured for payment.

5.09 Removal of Defective Work. Any defective work shall be removed and replaced at the Contractor's expense. Should the Contractor fail or refuse to remove defective work when so ordered by the Engineer, the Engineer shall have authority to order the Contractor to suspend further operations and may withhold payment on estimates until such defective work has been removed and replaced in accordance with the plans and specifications. Continued failure or refusal on the part of the Contractor to correct defective work promptly shall be sufficient cause for the City to declare the contract in default and to proceed to have the work completed in accordance with these specifications under section entitled Abrogation.

5.10 Final Inspection. Upon notification by the Contractor or Contractor's authorized representative that the work is completed, the Engineer shall make prompt final inspection of each item of work included in the contract. If the work is found to not be in accordance with the contract documents, the Contractor will be advised as to the particular defects to be remedied.

SECTION 6 - CONTROL OF MATERIALS

6.01 Source of Supply and Quality Requirements. The materials used on the work shall meet all quality requirements of the contract. In order to expedite the inspection and testing of materials, the Contractor shall notify the Engineer of Contractor's proposed sources of materials prior to delivery. At the option of the Engineer, approval of the source or approval of materials at the source prior to delivery may be required. If it is found after trial that sources of supply for previously approved materials do not produce specified products or when conditions are such that the use of unfit materials cannot be prevented except by extraordinary inspection methods, the Contractor shall

furnish materials from other sources. Before delivery is started and at any time during the process of preparation and use, the materials shall be subject to the approval of the Engineer.

6.02 Methods of Sampling and Testing, and Cited Specifications. Sampling and testing of all materials and the laboratory methods and testing equipment required under these specifications shall be in accordance with the latest published standard method of the AASHTO, except as otherwise provided.

The sampling and testing of all materials not covered by the AASHTO, but not otherwise provided for, shall conform to the latest published standard or tentative methods of the ASTM.

6.03 Storage of Materials. The Contractor shall be responsible for the care and storage of materials delivered at the work site or purchased for use thereon. Any material that has been delivered to the work site and has become damaged before actual incorporation in the work may be rejected by the Engineer even though it may previously have been accepted. Stored materials shall be so located as to facilitate thorough inspection.

6.04 Unacceptable Materials. All materials not conforming to the requirements of the specifications at the time they are to be used shall be considered as unacceptable, and all such materials will be rejected and shall be removed immediately from the site of the work unless otherwise instructed by the Engineer. No rejected materials, the defects of which have been corrected, shall be used until approval has been given.

6.05 Guarantee. The Contractor shall be responsible for any and all defects which may develop in any part of the entire installation furnished by said Contractor and, upon receipt of written notice from the Engineer, shall immediately replace and make good without expense to the City any such faulty part or parts and damage done by reason of same during a period of one (1) year from the date of formal acceptance of the installation (except when specific guarantee for another length of time is elsewhere specified).

The acceptance of the installation, or any part of it, shall not act to waive this liability on the part of the Contractor.

Upon completion and formal acceptance of the work, the Contractor may furnish a satisfactory bond in an amount of fifteen percent (15%) of contract price to insure the provisions of this guarantee. Otherwise, the original bond shall remain in full force and effect until final acceptance of the work, which acceptance shall be made one (1) year after the formal acceptance of the work as provided herein.

6.06 "Or Equal" Clause. Whenever, in any section of the contract documents, plans, or specifications, any article, material, or equipment is defined by describing a proprietary product or by using the name of a manufacturer or vendor, the term "or approved equal", if not inserted, shall be implied. The specific article, material, or equipment mentioned shall be understood as indicating the type, function, minimum standard or design, efficiency, and quality desired and shall not be construed in such a manner as to exclude manufacturer's products of comparable quality, design, and efficiency. The Engineer shall determine the acceptability of articles, materials, or equipment proposed as equals.

SECTION 7 - LEGAL RELATIONS AND RESPONSIBILITY TO THE PUBLIC

7.01 Laws to be Observed. The Contractor shall keep fully informed of and, at all times, shall observe and comply with all Federal and State laws, all local bylaws, ordinances, and regulations, and all orders and decrees of bodies or tribunals having any jurisdiction or authority which in any manner affect those engaged or employed on the project, or which in any way affect the project. The Contractor shall protect and indemnify the City and its representatives against any claim or liability arising from or based on the violation of any such law, ordinance, regulation, order, or decree, whether by said Contractor or Contractor's employees. It shall be the responsibility of the Contractor to provide all safeguards, safety devices, and protective equipment and to take any other needed actions as are reasonably necessary to protect the life and health of employees on the project.

7.02 State and City Fair Labor Standards. The Contractor agrees to comply with all applicable State and City fair labor standards in the execution of the contract, including compliance with Section 73-102, R.R.S. 1943. The Contractor further agrees to comply with the provisions of Section 48-657, R.R.S. 1943, pertaining to contributions to the Unemployment Compensation Fund of the State of Nebraska. In addition, the Contractor agrees to comply with the provisions of Section 52-118, R.R.S. 1948, pertaining to payment of all labor performed and for payment for materials and equipment rental which is actually used in performing this contract.

7.03 Anti-discrimination. During the performance of the work, the Contractor agrees not to discriminate against any employee or application for employment because of race, color, age, religion, sex, or national origin.

7.04 Permits. The Contractor shall procure and pay for all permits, licenses, and bonds necessary for the prosecution of Contractor's work and/or required for municipal, State, and Federal regulations and laws.

7.05 Patents. The Contractor and the surety in all cases shall indemnify and save harmless the City for any costs, expenses, and damages which it may be obligated to pay by reason of any such infringement at any time during the prosecution of or after the completion of the project.

7.06 Restoration of Surfaces Opened by Permit. Upon the presentation of a duly authorized and satisfactory permit from the City which provides that all necessary repair work will be paid for by the party to whom such permit is issued, the Engineer may authorize the Contractor to allow parties bearing such permits to make openings in the street. The Contractor shall, when ordered by the Engineer in writing, make in an acceptable manner all necessary repairs due to such openings, and such necessary work ordered by the Engineer shall be paid for on the basis of "Extra Work" as provided for in these specifications and shall be subject to the same conditions as original work performed.

7.07 Safety, Health, and Sanitation. In the performance of the contract, the Contractor shall comply with all applicable Federal, State, and local laws governing safety, health, and sanitation. The Contractor shall furnish such additional safeguards, safety devices, and protective equipment and shall take actions as the Engineer may determine as being reasonably necessary to protect the life and health of Contractor's employees and the public.

7.08 Barricades and Warning Signs. Except as otherwise provided specifically in this section, the Contractor shall provide and maintain barricades, danger and warning signs, and suitable and efficient lights, and shall take every reasonable precaution to prevent accidents. The name of the Contractor shall be clearly visible on the barricades. The Contractor shall provide, at their own expense, such watchmen as are necessary to protect their equipment and to maintain proper lights.

Watchmen who may be necessary to direct traffic or prevent travel on any portion of the street shall be provided by the Contractor on written order from the Engineer. Unless the contract specifically provides that such watchmen are to be furnished by the Contractor, this expense shall be paid for as provided in "Extra Work."

7.09 Use of Explosives. When the use of explosives is necessary for the prosecution of the work, the Contractor shall use the utmost care not to endanger life or property. All explosives shall be stored in a secure manner, and storage places shall be clearly marked "DANGER--EXPLOSIVES."

7.10 Claims for Labor and Materials. The Contractor shall indemnify and save harmless the City from all claims for labor and materials furnished under this contract. When requested by the City, the Contractor shall submit satisfactory evidence that all persons, firms, or corporations who have done work or furnished materials under this contract, for which the City may become liable under the laws of the State, have been fully paid or satisfactorily secured. In case such evidence is not furnished or is not satisfactory, an amount will be retained from money due the Contractor which, in addition to any other sums that may be retained, will be sufficient, in the opinion of the City, to meet all claims of the persons, firms, and corporations as aforesaid. Such sum shall be retained until the liabilities as aforesaid are fully discharged or satisfactorily secured.

7.11 Contractor's Insurance. The Contractor shall secure and maintain throughout the duration of this contract insurance, from companies authorized to do business in Nebraska, of such types and in such amounts as may be necessary to protect themselves and the interests of the City against all hazards or risks of loss as hereinafter specified. This insurance shall cover all aspects of the Contractor's operations and completed operations. The form and limits of such insurance, together with the underwriter thereof in each case, shall be approved by the City, but regardless of such approval it shall be the responsibility of the Contractor to maintain adequate insurance coverage at all times. Failure of the Contractor to maintain adequate coverage shall not relieve them of any contractual responsibility or obligation. Minimum insurance coverage shall be the amounts stated herein or the amounts required by applicable law, whichever are greater.

1. "Worker's Compensation and Employer's Liability." This insurance shall protect the Contractor against all claims under applicable State worker's compensation laws. This insurance shall provide coverage in every state in which work for this project might be conducted. The Contractor shall also be protected against claims for injury, disease, or death of employees which, for any reason, may not fall within the provisions of a worker's compensation

law. This policy shall include an "all states" endorsement. The liability limits shall be not less than the following:

| | |
|-----------------------|-------------------------|
| Worker's Compensation | Statutory Limits |
| Employer's Liability | \$100,000 each accident |
| | \$100,000 each employee |
| | \$500,000 policy limit |

2. "Business Automobile Liability." This insurance shall be written in comprehensive form and shall protect the Contractor, Contractor's employees, or subcontractors from claims due to the ownership, maintenance, or use of a motor vehicle. The liability limits shall be not less than the following:

| | |
|---------------------------------|---------------------------------|
| Bodily Injury & Property Damage | \$500,000 Combined Single Limit |
|---------------------------------|---------------------------------|

3. "Comprehensive General Liability." The comprehensive general liability coverage shall contain no exclusion relative to explosion, collapse, or underground property. The liability limits shall be not less than the following:

| | |
|---------------------------------|----------------------------|
| Bodily Injury & Property Damage | \$ 500,000 each occurrence |
| | \$1,000,000 aggregate |

4. "Umbrella Liability Insurance." This insurance shall protect the Contractor against claims in excess of the limits provided under employer's liability, comprehensive automobile liability, and commercial general liability policies. The umbrella policy shall follow the form of the primary insurance, including the application of the primary limits. The liability limits shall not be less than the following:

| | |
|---------------------------------|-------------------------------|
| Bodily Injury & Property Damage | \$1,000,000 each occurrence |
| | \$1,000,000 general aggregate |

5. Additional Requirements. The City may require insurance covering a Contractor or Subcontractor more or less than the standard requirements set forth herein depending upon the character and extent of the work to be performed by such Contractor or Subcontractor.

Insurance as herein required shall be maintained in force until the City releases the Contractor of all obligations under the contract.

The Contractor shall provide and carry any additional insurance as may be required by special provisions of these specifications.

6. Certificate of Insurance. Satisfactory certificates of insurance shall be filed with the City prior to starting any work on this contract. The certificates shall show the City as an additional insured on all coverage except Workers Compensation. The certificate shall state that thirty (30) days written notice shall be given to the City before any policy is cancelled (strike the "endeavor to" wording often shown on certificate forms). If the Contractor cannot have the "endeavor to" language stricken, the Contractor may elect to provide a new certificate of insurance every thirty (30) days during the contract. The Contractor shall immediately notify the City if there is any reduction of coverage because of revised limits or claims paid which affect the aggregate of any policy.

7.12 Proof of Carriage of Insurance. Satisfactory certificates of insurance shall be filed with the City prior to starting any construction work on this contract. The certificates shall show the City as "Additionally Insured." The certificates shall state that thirty (30) days written notice shall be given to the City before any policy covered thereby is changed or canceled (strike the "endeavor to" wording often shown on certificate forms).

7.13 Contractor's Responsibility for Utility Property and Services. At points where the Contractor's operations are adjacent to properties of railway, telegraph, telephone, and power companies or adjacent to other property to which damage might result, work shall not be commenced until all arrangements necessary for the protection thereof have been made.

The Contractor shall cooperate with the owners of any underground or overhead utility lines in their removal and rearrangement operations in order that these operations may progress in a reasonable manner, that duplication of rearrangement work may be reduced to a minimum, and that services rendered by those parties will not be unnecessarily interrupted.

In the event of interruption to water or utility services as a result of accidental breakage or as result of being exposed or unsupported, the Contractor shall promptly notify the proper authority. Contractor shall cooperate with said authority in the restoration of service as promptly as possible. In no case shall interruption to water service be allowed to exist outside of working hours. Fire hydrants shall be kept accessible to the Fire Department at all times and no materials shall be kept or stockpiled within fifteen (15) feet of any fire hydrant.

The Contractor must cooperate with the utility companies and schedule work in such a manner as to protect the existing utility facilities until the facilities are abandoned or replacement facilities are completed. In instances where partial grading is necessary before a utility can install its facilities, the Contractor shall consult with the utility and plan the work so reasonable time can be allowed the utility for completing its work.

7.14 No Waiver of Legal Rights. The City shall not be precluded or estopped by any measurement, estimate, or certificate made either before or after the completion and acceptance of the work and payment therefor from showing the true amount and character of the work performed and materials furnished by the Contractor, nor from showing that such measurement, estimate, or certificate is untrue or is incorrectly made, nor that the work or materials do not in fact conform to the contract. The City shall not be precluded or estopped, notwithstanding any such measurement, estimate, or certificate and payment in accordance therewith, from recovering from the Contractor or Contractor's sureties, or both, such damage as it may sustain by reason of Contractor's failure to comply with the terms of the contract. Neither the acceptance by the City or any representative of the City, nor any payment for or acceptance of the whole or any part of the work, nor any extension of time, nor any possession taken by the City shall operate as a waiver of any portion of the contract or of any power herein reserved or of any right to damages. A waiver of any breach of the contract shall not be held to be a waiver of any other or subsequent breach.

7.15 Exposure of Pipe or Manholes. The Contractor shall conduct the work at all times in such a manner as will insure no disruption to the normal function of the sanitary sewer collection system. Particular attention shall be paid to the threat of introduction of storm water or other waters to the piping and manholes of the collection system. The Contractor shall take whatever precautions are necessary, such as, but not limited to installation of plugs in exposed pipes and manholes when work is not in progress or when leaving the work site. The Contractor will be held responsible for damages which may occur to either the collection system or to private property through introduction of storm water or other waters to exposed piping or manholes relating to the construction work.

SECTION 8 - PROSECUTION AND PROGRESS

8.01 Subletting or Assigning of Contract. The Contractor will not be permitted to sublet, assign, sell, transfer, or otherwise dispose of the contract or any portion thereof or Contractor's right, title, or interest therein or to either legally or equitably assign any of the money payable under Contractor's contract or claim thereto without the written consent of Contractor's surety and the Engineer. The Contractor will not be relieved of any responsibility through any of the above actions.

8.02 Prosecution of Work. The bid for each project will show the contract period. The progress of the work shall be at a rate sufficient to complete the contract within the contract period. If it appears that the rate of progress is such that the contract will not be completed within the contract period or if the work is not being executed in a satisfactory and workmanlike manner, the City may order the Contractor to take such steps as it considers necessary to complete the contract within the period of time specified or to prosecute the work in a satisfactory manner. If the Contractor fails to comply with such order within two (2) weeks after receipt of the order, Contractor shall automatically be disqualified from receiving any additional contract awards, and the City shall have the right to declare the contract in default and to complete the work in accordance with these specifications under section entitled Abrogation.

The Contractor's sequence of operations shall be such as to cause as little inconvenience to the general public as possible.

The Contractor will be granted additional and suitable time for the prosecution of the work, as was lost by reason of a delay or delays attributable to other parties authorized to do work on the project over which the Contractor had no control or jurisdiction, as provided in these specifications under section entitled Extension of Contract Period.

8.03 Limitations of Operations. The Contractor shall conduct the work at all times in such a manner and in such sequence as will insure the least interference with traffic. Contractor shall have due regard to the location of detours and to the provisions of handling traffic. Contractor shall not open up work to the prejudice of work already started, and the Engineer may require the Contractor to finish a section on which work is in progress before work is started on any additional section. The Contractor shall so conduct operations and maintain the work in such condition that adequate drainage shall be in effect at all times.

8.04 Methods and Equipment. The methods, equipment, and appliances used shall produce a satisfactory quality of work and shall be adequate to maintain the schedule of progress specified. Equipment used on any portion of the project shall be such that no injury to the roadway, adjacent property, or other streets will result from its use.

When the methods and equipment to be used by the Contractor in accomplishing the construction are not prescribed in the contract, the Contractor is free to use any methods or equipment that is demonstrated to accomplish the contract work in conformity with the requirements of the contract to the satisfaction of the Engineer.

When the contract specifies that the construction be performed by the use of certain methods and equipment, such methods and equipment shall be used unless others are authorized by the Engineer. If the Contractor desires to use a method or type of equipment other than those specified in the contract, a request may be made to the Engineer for authority to do so. The request shall be in writing and shall include a full description of the methods and equipment proposed to be used and an explanation of the reasons for desiring to make the change. If approval is given, it will be on the condition that the contractor will be fully responsible for producing construction work in conformity with contract requirements. If, after trial use of the substituted methods or equipment, the Engineer determines that the work produced does not

meet contract requirements, the Contractor shall discontinue the use of the substitute method or equipment and shall complete the remaining construction with the specified methods and equipment. The Contractor shall remove the deficient work and replace it with work of specified quality or take such other corrective action as the Engineer may direct. No change will be made in basis of payment for the construction items involved nor in contract time as result of authorizing a change in methods or equipment under these provisions.

8.05 Temporary Suspension of Work. Work shall be suspended wholly or in part when, in the opinion of the Engineer, weather or other conditions are unfavorable to its satisfactory prosecution. Work shall also be suspended at the direction of the Engineer pending settlement of disputes arising out of failure of the Contractor to comply with the provisions of the contract. Written notice of suspension of work shall be given by the Engineer. When the conditions causing suspension no longer exist, such written notice shall be given to the Contractor by the Engineer. Promptly after such written notice, the Contractor shall resume prosecution of the work as provided in these specifications under section entitled Prosecution of Work.

8.06 Liquidated Damages. Time is an essential element of the contract, and it is important that the work be pressed vigorously to completion.

For each calendar day that any work shall remain uncompleted after the end of the contract period, the amount per calendar day specified in the bid form will be assessed, not as a penalty but as predetermined and agreed liquidated damages. The City will prepare and forward to the Contractor an invoice for such liquidated damages. The final payment will be withheld until payment shall have been made of this invoice.

Due account shall be taken of any adjustment of the contract period granted under the section of these specifications entitled Extension of Contract Period.

The assessment of liquidated damages for failure to complete the work within the contract period shall not constitute a waiver of the City's right to collect any additional damages which the City may sustain by failure of the Contractor to carry out the terms of the contract.

8.07 Extension of Contract Period. An extension of the contract period may be granted by the City for any of the following reasons:

1. Additional work resulting from a modification of the plans for the project
2. Delays caused by the City
3. Other reasons beyond the control of the Contractor which, in the City's judgment, would justify such extension.

No extension of contract period will be allowed for variations between contract quantities and actual quantities which cannot be predetermined and which amount to less than twenty percent (20%) of the contract quantities.

8.08 Abrogation. If the Contractor abandons, sublets, or assigns the work under this contract without the consent of the City, or if Contractor fails to give - personal attention to it, or if it is the Engineer's opinion, and is so certified in writing to the Contractor and the City, that the Contractor is violating any of the provisions of this contract or that Contractor is not prosecuting the work in good faith or at the rate of progress specified, or that Contractor has unnecessarily or unreasonably delayed or neglected the work or any part of it, written notice to that effect is to be given to the Contractor by the Engineer. After such notice, no materials or equipment shall be removed from the work. If, within five (5) days thereafter, the Contractor does not take steps, which in the judgment of the Engineer will insure the satisfactory completion of the work, then the City may declare this contract null and void and the security forfeited and may notify the Contractor in writing to discontinue the work or any part of it; thereupon ceasing the Contractor's right of possession of the ground and of all materials and equipment thereon. The City then, at

their option, may enter upon and take possession of the work with all materials, supplies, and equipment remaining thereon and by contract or otherwise, as the City may determine, may complete the work or the part of it designated and charge the expense thereof to the Contractor using any materials or equipment found on the site. The expense so charged, together with all damages incurred, will be deducted from any funds due or to become due under this contract and, should the unexpended balance of these funds be insufficient, the excess shall be at the cost of the Contractor and sureties on the Contractor's bond. Neither completion of a part of the work nor the extension for any reason of the time of the completion of the work is to be considered a waiver of this right to abrogate the contract for abandonment, delay, or unsatisfactory work.

8.09 Termination of Contractor's Responsibility. The contract shall be considered completed when the work has been accepted in writing by the City. Such acceptance shall release the Contractor from all further obligation with respect thereto, except as to conditions and requirement set forth in Contractor's bond.

SECTION 9 - MEASUREMENT AND PAYMENT

9.01 Payments. Payments for estimated work completed will be made only on certificates of the Engineer at a regular City Council meeting.

The City, at its discretion, may include in such estimates payments for materials that will eventually be incorporated in the project, provided that such materials are suitably stored on the site of the project at the time of preparing estimates for payment. Such payment is to be based upon the estimated value thereof as ascertained by the Engineer. Such material when so paid for by the City shall not be removed from the project without consent of the City and, in case of default on the part of the Contractor; the City may use or cause to be used by others these materials in construction of the project.

The City will retain five percent (5%) of the estimated amount of work executed in an approved manner and of the approved materials and apparatus suitably stored on the site.

Payment of the retained five percent (5%) will be made within sixty (60) days after the formal approval and acceptance by the Engineer of all apparatus, materials, and work embraced in the contract.

9.02 Payments Withheld. The City may withhold or, on account of subsequently discovered evidence, nullify the whole or a part of any certificate to such extent as may be necessary to protect itself from loss on account of:

1. Defective work not remedied
2. Claims filed or reasonable evidence indicating probable filing of claims
3. Failure of the Contractor to make payments properly to subcontractors or for materials or labor
4. A reasonable doubt that the contract can be completed for the balance then unpaid
5. Damage to another contractor.

When the above grounds are removed, payment shall be made for amounts withheld because of them.

9.03 Acceptance and Final Payment. If final inspection reveals that all details of the work have been completed satisfactorily, the Engineer shall tentatively accept the work, in writing, relieving the Contractor of further responsibility for the care and maintenance of the completed work and, provided that all equipment and materials have been removed from the right-of-way, shall also relieve the Contractor of further public liability. As soon as possible after tentative

acceptance of the work, the Engineer shall measure the completed work and compute the quantities of work for which payment is to be made. Before final settlement is made, the City shall be satisfied with the completed work. When the Engineer is satisfied that all items of the work have been found to be consistent with the terms of the contract and specifications, a final estimate including the retained percentage due the Contractor shall be released for payment. Release of the final estimate shall constitute final acceptance of the work.

All prior partial estimates and payments shall be subject to correction in the final estimate and payment.

Extra work - See these specifications under section entitled Extra Work.

9.04 Payment for Extra Work. The Contractor will receive and accept payment for work performed under the contract as follows:

1. Items of work performed which are covered by definite prices stipulated in the contract. For all items of work performed which are covered by definite unit prices or lump sum amounts specified in the contract, the Contractor shall receive and accept compensation at the rate specified in the contract.

2. Extra work ordered by the Engineer, of a quality or class not covered by the contract, will be paid for at an agreed price. For extra work ordered by the Engineer and performed on an agreed price basis, the Engineer and the Contractor shall enter into a written agreement, and have City Council approval, before such work is undertaken. This written agreement shall describe the extra work that is to be done and shall specify the agreed price or prices therefore.

Revised 1-25-2011

SPECIAL PROVISION
GENERAL REQUIREMENTS & ROADWAY IMPROVEMENT ITEMS
18th Street PAVING IMPROVEMENTS
PAVING PROJECT #2022-P-8

COORDINATING PROFESSIONAL



Table of Contents

| | <u>Page No.</u> |
|---|-----------------|
| SP 100. GENERAL REQUIREMENTS..... | 3 |
| SP 200. SURFACING SPECIALS | 14 |
| SP 300. STORM SEWER AND SANITARY SEWER SPECIALS | 17 |
| SP 400. GRADING AND REMOVALS SPECIALS | 19 |
| SP 500. PAVEMENT MARKINGS & SIGNAGE SPECIALS | 26 |
| SP 600. MEASUREMENT AND PAYMENT | 27 |

SP 100.GENERAL REQUIREMENTS

SP 101. SPECIFICATIONS AND STANDARD PLAN DRAWINGS

The work as detailed on the plans shall be completed in accordance with the requirements of the City of Grand Island Standard Specifications as supplemented by the Nebraska Department of Transportation 2017 English Edition of the Standard Specifications for Highway Construction. The City of Grand Island Standard Specifications, the Nebraska Department of Transportation 2017 English Edition of the Standard Specifications for Highway Construction, including all amendments and additions thereto effective at the date of the contract, the Special Provisions and plans shall be considered a part of this Contract, whether or not attached into these specifications, and it shall be the Contractor's responsibility to comply with all requirements thereof. A requirement occurring in one is as binding as though occurring in all. They are intended to be complementary and to describe and provide for a complete project.

In case of a discrepancy:

1. The City of Grand Island Standard Specifications shall govern over the Nebraska Department of Transportation 2017 English Edition of the Standard Specifications for Highway Construction.
2. Special Provisions shall govern over the City of Grand Island Standard Specifications.
3. The plans shall govern over the Special Provisions.

The Contractor shall not take advantage of any apparent error or omission in the plans or specifications. Upon discovery of such an error or omission, the Contractor shall notify the Engineer immediately. The Engineer will then make such corrections or interpretations as necessary to fulfill the intent of the plans and specifications.

Any reference to the NDOT (Nebraska Department of Transportation) in the Standard Specifications or Special Provisions shall be considered reference to the City of Grand Island, its employees, or representatives hired by the City of Grand Island as a consultant for construction project management.

SP 102. PAYMENT & PERFORMANCE BOND

Payment and performance bond shall be required for the contractual work.

SP 103. SCHEDULE & CALENDAR DAY ALLOWANCES

All contract work shall be substantially completed by September 1, 2023 and ready for final acceptance by November 30, 2023. Substantially complete is defined that all pavements including driveways and sidewalks and striping is completed and open to traffic. Final acceptance is defined that all items are complete for the project including any final punch list items and establishment of all seeded areas.

SP 104. SUBMITTALS

Complete shop drawings are required for all materials proposed to be incorporated in the work. The Contractor shall submit two hard copies, or one digital PDF copy, to the Engineer for approval. Drawings and listings shall be submitted immediately after the contract is executed. No equipment or materials shall be incorporated into the work until reviewed by the Engineer.

Per [City of Grand Island standard specifications section 5.02](#), the Contractor shall hereby have the option to submit 11"x17" PDF shop plans upon request and approval by the Engineer.

Shop drawings shall be clear and distinct and acceptable to the Engineer.

Each submittal shall be accompanied by a letter of transmittal and shall further reference the applicable section(s) of the specifications and plans in which the submittal corresponds to.

Neither review nor acceptance of submittals by the Engineer shall relieve the Contractor from responsibility for errors, omissions, or deviations from the Contract Documents, unless such deviations were specifically called to the attention of the Engineer in the letter of transmittal. The Contractor shall be responsible for the correctness of the submittal. The Contractor shall allow a minimum of fourteen (14) working days for review of submittals unless otherwise specified. The Engineer will provide a PDF copy of the reviewed shop drawings/submittals with comments to the Contractor. Hard copies of the reviewed shop drawings/submittals will only be provided upon request by the Contractor.

Contractor shall keep a master copy set of all reviewed shop drawings on the project site at all times for review/use by Contractor employees, City employees, Subcontractor employees, and the Engineer. The master copy set shall be kept in a location that is easily accessible by all parties at all times (typically the 'job trailer').

SP 105. CERTIFICATION

The Engineer may waive materials testing requirements of the specifications and accept the manufacturer's written certification that the materials to be supplied meet those requirements. Materials test data may be required as part of the certification.

SP 106. MATERIALS

Materials on hand payment will be made for items on this project. The items are to be properly stored and secured. If items are not properly stored and secured no materials on hand payments will be made.

SP 107. EXEMPT SALES CERTIFICATE

Contractor shall pay all sales, consumer, use, and other similar taxes required to be paid by Contractor in accordance with the Laws and Regulations of the place of the Project which are applicable during the performance of the Work. It is the responsibility of the Contractor to understand the tax laws and pay taxes in accordance with these laws.

The Contractor performing work under this contract will be issued a Purchasing Agent Appointment and Exempt Sales Certificate signed by the authorized representative of the City. This is to be used by the Contractor when purchasing tangible property to be actually incorporated into the contract work. It does not apply to either (1) the purchase of materials to be used but not incorporated into the contract work, including but not limited to form lumber, scaffolding, etc., or (2) the purchase or rental of machinery, equipment or tools owned or leased by the Contractor and used in performing the contract work. The Contractor may reproduce copies of the Purchasing Agent Appointment and Exempt Sales Certificate to furnish their suppliers on each invoice or order.

SP 108. RIGHT OF WAY

Rights-of-way, easements, or rights-of-entry for the Work will be provided by the City. Unless otherwise provided, the Contractor shall make arrangements, pay for, and assume all responsibility for acquiring, using, and disposing of additional work areas and facilities temporarily required. The Contractor shall indemnify and hold the City harmless from all claims for damages caused by such actions.

SP 109. STAGING AREA

The Contractor shall be responsible for obtaining and maintaining an area for material in use, all construction material, equipment, etc. shall be stored in this area and not in the public right-of-way.

Upon completion of the project, the Contractor shall restore the staging area to equal or better than original condition, including but not limited to, re-grade and reseed in compliance with the specifications.

SP 110. TEMPORARY CONSTRUCTION EASEMENTS

The Contractor is expected to confine all work activities to the permanent and temporary easements and right of way. Failure to do so will result in damages to private property and bad public relations. The City will stake out easement limits. Any property damage done beyond these limits will be assessed against the Contractor. The City will negotiate with the property owners who are damaged, make payment to the owner, and pass the costs to the Contractor plus \$50.00 for each occurrence by deduction from monies due the Contractor. The Contractor will have no voice in damages less than \$1,000. Contractor will be bound by the City's negotiated settlement. For damages greater than \$1,000.00, the Contractor may participate in negotiations. The Contractor and the property owner must both approve settlement over \$1,000.

SP 111. PROPERTY CORNERS

It shall be the Contractor's responsibility to protect existing property corners and government surveying monuments. If property corners are disturbed or destroyed during construction, it shall be the Contractor's obligation to employ a licensed land surveyor to replace those damaged or destroyed corners. No extra or additional payment will be made for restoration of property corners.

SP 112. SANITATION

The Contractor shall provide and maintain enclosed toilets for the use of employees and public engaged in the Work Area. These accommodations shall be maintained in a neat and sanitary condition. They shall also comply with all applicable laws, ordinances, and regulations pertaining to public health and sanitation of dwellings and camps.

Wastewater shall not be interrupted. Should the Contractor disrupt existing sewer facilities, sewage shall be conveyed in closed conduits and disposed of in a sanitary sewer system. Sewage shall not be permitted to flow in trenches or be covered by backfill.

SP 113. TEMPORARY LIGHT, POWER, AND WATER

The Contractor shall furnish, install, maintain, and remove all temporary light, power, and water at its own expense. These include piping, wiring, lamps, and other equipment necessary for the Work. The Contractor shall not draw water from any fire hydrant, without obtaining written authorization, payment of fees, and backflow connection devices from the water agency concerned.

For any work required to be completed at night, the Contractor shall provide supplemental construction lighting when the existing surrounding area lights so not provide acceptable illumination. The lighting shall be as required to provide a safe environment for all personnel on site, but as to not interfere with surrounding homes and businesses. The construction areas lighting shall illuminate construction work areas, haul routes, staging areas as required. The lighting shall conform to OSHA (Occupational Safety & Health Administration) standards, 29 CFR, Part 1926, Safety and Health Regulations, including the minimum illumination intensities as outlined in Sub-Part 1926.56, Table D-3. The Owner reserves the right to limit or restrict the height/location of all temporary construction lighting.

SP 114. AIR QUALITY AND OPEN BURNING

The Contractor must comply with the Nebraska Department of Environmental Quality Rules and Regulations for the control of Air Quality as promulgated in Title 129 of Nebraska Administrative Code. Open fires are allowed if local regulations are satisfied. All solid waste generated by the project will be disposed of in accordance with Title 132, Integrated Solid Waste Management.

SP 115. EXPLOSIVE AND FLAMMABLE OPERATIONS

During project development, the work area was determined to not be located within the immediate vicinity of hazardous industrial operations handling fuel or chemicals of an explosive or flammable nature, in accordance with regulation 24 CFR Part 51 Subpart C. Appropriate mitigation measures will be applied should any potential hazards be identified.

SP 116. NPDES/SWPPP & BEST MANAGEMENT PRACTICES

This project will require the Contractor to ensure compliance with all aspects of the National Pollutant Discharge Elimination System (NPDES) General NPDES Permit Number NER110000 for Storm Water Discharges from Construction Sites to Waters of the State of Nebraska and the City's Code Chapter 40 Storm Water Management. The Contractor shall exercise every reasonable precaution to protect channels, storm drains, and bodies of water from pollution. It shall conduct and schedule operations so as to minimize or avoid muddying and silting of said channels, drains, and waters. Water pollution control work shall consist of constructing those facilities which may be required to provide prevention, control, and abatement of water pollution.

A construction site storm water permit Notice of Intent for this project will be prepared by the Owner and Engineer. The Owner and Contractor shall be listed as permittees and shall be required to sign the Notice of Intent. The Permit is issued under the General Permit of the National Pollutant Discharge Elimination System for Storm Water Discharges.

The Owner and Engineer shall develop a Storm Water Pollution Prevention Plan (SWPPP) and the Contractor shall implement the SWPPP to: minimize erosion on disturbed areas; minimize the discharge of sediment and other pollutants in storm water runoff; and maintain compliance with the requirements of NPDES Permit. The Contractor shall familiarize himself with the requirements of NPDES Permit, monitoring requirements and procedures, and periodic reporting and record keeping requirements respectively. The word "permittee" shall be replaced with "Contractor" in the above referenced sections of NPDES Permit. Physical erosion and sediment control structures used at the site shall be sufficient to comply with the requirements of the permit.

The Contractor will install and maintain Best Management Practices (BMPs) to include silt fence, construction rock entrances or silt checks if needed. Any delay in the replacement or maintenance of nonfunctional BMPs beyond seven (7) calendar days shall be documented in the SWPPP with sufficient detail as to explain the reason for the delay. (See City of Grand Island's SWPPP Review Checklist). The Contractor shall be responsible for ensuring that final stabilization is accomplished on all non-impervious surfaces of the authorized construction site prior to submitting form CSW-NOT. A uniform perennial vegetative cover with a minimum density of 70 percent of the native background vegetative cover is required for final stabilization.

The City may perform periodic drive-by inspections and provide the Contractor any findings, but the contractor will be responsible for the routine/rain fall event inspections.

SP 117. DISCHARGE WATER

All dewatering discharge water shall be conveyed to locations to be approved by the City. It will be the Contractor's responsibility to make driveway and street crossings in such a manner as to not interfere with normal use. The Contractor will be allowed to utilize the existing detention cells and storm sewers for the dewatering discharge water. The Contractor is required to secure all permits, and properly fill and abandon the wells as per State Statute after use. The Contractor is not allowed to block streets, driveways, or sidewalks with discharge piping or power codes. The Contractor shall use drive over ramps other approved measures to maintain access to streets, driveways, and sidewalks.

The project will require the Contractor to ensure compliance with all aspects of the National Pollutant Discharge Elimination System (NPDES) General NPDES Permit Number NEG671000 for Dewatering Discharges. The Contractor shall ensure all provisions of the permit are followed, field samples, submittals to Notice of Intent (DW-NOI), Checklists, Discharge Monitoring Report (DW-DMR), Physical Characteristic Examination Report (PCE), and any Non-Compliance Reports.

All documentation on the dewatering operations shall be recorded and archived by the Contractor for the duration to the project. The acquired field grabs or composite sampling, and flow measurement of dewatering discharges shall be the responsibility of the Contractor. The City shall provide the sample bottles and lab work in testing pH, Total Petroleum Hydrocarbons, and Total Suspended Solids. The Contractor shall work jointly with the city's lab representative in scheduling testing at the Waste Water Treatment Plant.

The City shall be copied on all documentation and reports.

SP 118. PROTECTION AND RESTORATION OF EXISTING IMPROVEMENTS

Contractor shall be responsible for the protection of public and private property adjacent to the Work and shall exercise due caution to avoid damage to such property. All property and structures shall be protected unless their removal is shown on the Contract drawings or authorized by the City.

The Contractor shall repair or replace all existing improvements within the right-of-way which are designated or not designated for removal (e.g., curbs, sidewalks, driveways, fences, walls, signs, utility installations, pavement, structures, etc.) which are damaged or removed as a result of its operations. When a portion of a sprinkler system within the right-of-way must be removed, the heads shall be salvaged to the owner and the remaining lines shall be capped such that the system can still be used.

Trees, lawns, and shrubbery that are not to be removed shall be protected from damage or injury. If damaged or removed due to Contractor's operations, they shall be restored or replaced in as nearly the original condition and location as is reasonably possible.

All costs to the Contractor for protecting, removing, and restoring existing improvements shall be included in the Bid.

SP 119. PUBLIC CONVENIENCE AND SAFETY

Public relations are a very important part of this type of work. The Contractor and its employees need to recognize the necessity to be courteous to the public and especially to landowners on whose property or near whose property they are working.

The Contractor's operations shall cause no unnecessary inconvenience. The access rights of the public shall be considered at all times. Unless otherwise authorized, traffic shall be permitted to access each property in some way, or an approved detour shall be provided. The contractor is responsible for coordinating with the City, residents, and businesses within the project area to provide temporary access as needed.

Safe and adequate pedestrian and vehicular access shall be provided and maintained to fire hydrants, sanitation services, mail distribution, commercial and industrial establishments, and circulations of similar nature. Access to these facilities shall be continuous and unobstructed unless otherwise approved by the Engineer.

Vehicular access to residential driveways shall be maintained to the property line except when necessary construction precludes such access for reasonable periods of time. If backfill has been completed to the extent that safe access may be provided, and the street is opened to local traffic, the Contractor shall immediately clear the street and driveways and provide and maintain access.

The Contractor shall cooperate with the various parties involved in the delivery of mail and the collection and removal of trash and garbage to maintain existing schedules for these services.

The Contractor shall include in its Bid all costs for the above requirements.

SP 120. SCHEDULE AND PHASING

The Contractor shall develop a construction schedule and phasing plan in accordance with the plans and these shall be submitted to the Engineer for approval prior to starting work on the project. The Contractor's schedule shall outline the anticipated start and completion dates for the various tasks required to substantially complete the various segments of the project as well as the proposed final completion date for the project. The schedule shall breakdown the work to outline all major construction activities including grading, paving of the phased roadway segments, utility work, storm sewer work, and final grading and seeding. The Contractor's schedule shall be developed with consideration given to minimizing disruption to adjacent property owners and businesses.

The Contractor shall not close any portion of the public roads or drive access to adjacent residents without the permission of the City. The Contractor shall at all times, to the extent practicable, provide facilities of ingress and egress to and from the public roadway to maintain access to adjacent properties throughout the duration of the project. This will require the Contractor to construct some temporary surfacing or temporary crushed rock surface course.

SP 121. STREET CLOSURES, DETOURS, BARRICADES

The Contractor shall comply with all applicable State, County and City requirements for closure of streets. The Contractor shall provide barriers, guards, lights, signs, temporary bridges and roadways, flag persons, and watchpersons. The Contractor shall be responsible for compliance with additional public safety requirements which may arise. The Contractor shall furnish and install signs and warning devices and promptly remove them upon completion of the Work. At least **72** hours in advance of closing, partially closing or reopening, any street, alley, or other public thoroughfare, the Contractor shall notify the Engineering Department, and comply with their requirements. **All** temporary traffic control plans that vary or are in addition to plans must first be approved in writing by the Engineer.

All costs involved shall be included in the Bid for applicable bids items. Any flagging required shall be considered subsidiary.

SP 122. PROPERTY OWNER COMMUNICATION

The City shall not be held responsible for any delay that the Contractor may encounter by reason of the property owners involved failing to promptly respond. It shall be the Contractor's responsibility to meet with the affected property owners as soon as possible to coordinate construction activities. It shall be the Contractor's responsibility to coordinate work, identify specific site needs with the property owners to accomplish the work. Additionally, the Contractor shall provide for the continuance of service of such property owners where such service may be disrupted as a result of the Contractor's operations.

SP 123. UTILITY MANAGEMENT

Existing underground installations (such as water mains, gas mains, sewers, telephone lines, power lines, and buried structures) in the vicinity of the work are to be verified by the Contractor. The Contractor shall be solely responsible for locating all existing underground installations which includes any additional potholing to verify depths. The Contractor shall use their own information and shall not solely rely upon any information indicated on the drawings concerning existing underground installations.

The Contractor shall proceed with caution in the excavation and preparation of the trench so that the exact location of all such utilities, both known and unknown may be determined, and the Contractor shall be held responsible for the repair of such utilities when broken or otherwise damaged. All such utilities shall be accurately located, including hand excavating by the Contractor as required, as incidental to the Contract and performed prior to machine excavation in the vicinity.

Any delay, additional work, or extra cost to the Contractor caused by existing installations shall not constitute a claim for extra work, additional payment or damages.

SP 124. POWER LINES

There are existing energized high-voltage electric power lines in the work area for this Contract. The Contractor shall use extreme caution such that personal safety is not jeopardized, and electric continuity is maintained. Due to soil conditions and proximity, all poles and underground cables shall be supported during excavation, properly backfilled and compacted to protect from damage.

The Contractor shall be required to notify the appropriate authority having jurisdiction and ownership, a minimum of seven (7) days prior to any work being performed adjacent or underneath the power line.

SP 125. SOIL TESTING

The Contractor will be responsible for the coordination of construction testing required by the Grand Island specifications and these special provisions. The City of Grand Island has hired Olsson to do soil testing and the Contractor shall work with Olsson to make them aware of timeline. The Contractor shall be responsible for scheduling of all services required.

Summary of Required Testing:

1. Soil Moisture-Density Relationship Curves (One for Each Soil Type Used)
2. Subgrade Moisture & Density Nuclear Gauge Tests
3. Subgrade Proof-Rolling Observation (Proof-Roll by Contractor)

The testing agency shall provide subgrade density tests reports for approval by Engineer prior to any concrete being placed. The Engineer shall be notified and allowed to witness proof rolling of subgrade and location of stringline prior to placement of concrete.

SP 126. CONCRETE TESTING

The City of Grand Island shall hire an engineering laboratory(olsson) to sample, test, inspect, and document the delivery and placement of all cementitious materials.

All sampling procedures for concrete and related materials shall be performed in accordance with current ASTM standard test methods, unless otherwise approved by the Engineer. Laboratory testing, field sampling and testing, and inspection or observations, shall be performed by ACI, NICET, or ICC certified personnel only, unless otherwise approved by the Engineering Department.

Testing agency shall submit reports in accordance with work assigned, for conformance with City of Grand Island plans, specifications, Additionally conduct and interpret tests and inspections and state in each report whether; (1) test specimens and observations comply with Contract Documents, and specifically state any deviations, (2) record work required and performed, (3) record types and locations of defects found in work, (4) Bring non-conforming items to the immediate attention of the Contractor, and if uncorrected to the Engineer, (5) Submit test and/or inspection reports to the Engineer, the Contractor and other designated persons.

Delivery Tickets must have the following information at the time of delivery; Plant or manufacture name and location, Project name, and location of delivery, Material batched: Mix # (Product code), including all additives, Date and Time batched, Time of arrival at site, Weight or cubic yards of material batched into truck, Truck number or license, Driver name, Gallons of water added after leaving the batch plant, including on-site, Signature by the Contractor's representative acknowledging receipt of the product, A copy of the delivery ticket shall be given to the Engineer or their representative at the time of delivery.

The testing frequency shall at minimum establish; four (4) test cylinders per day and every two hundred (200) cubic yards of cementitious materials placement.

SP 127. SURVEYING

The City of Grand Island's surveying agency (Olsson) will perform and be responsible for the accuracy of surveying adequate for construction. The agency shall provide field surveying and staking services for all utility, storm sewer drainage and pavement locations as identified in plan drawings. Contractor shall provide a minimum of two (2) days' notice to surveying agency prior to need of stakes to allow for scheduling. Agency shall notify Owner/Engineer of a staking section to provide for Owner/Engineer review and compliance check.

Surveying agency shall provide stakes, lath, sledges, hand tools, transportation, and such other supplies, assistance, and equipment as required in staking out the work. Each staking location shall be clearly marked.

The Contractor shall preserve construction survey stakes and marks for the duration of their usefulness. Stakes, once installed, shall become the responsibility of the Contractor. Replacement, because of loss or damage, shall be done at the expense of the Contractor.

The Contractor shall dig all holes necessary for line and grade stakes. Unless otherwise specified, stakes will be set and stationed for pavement, curbs, headers, sewers, storm drains, structures, and rough grade. A corresponding cut or fill to finished grade (or flowline) will be indicated on a grade stake. All work shall conform to the lines, elevations, and grades shown on the Plans. Grades for underground conduits will be set at the surface of the ground.

SP 128. INSPECTION

The Work is subject to inspection and approval by the Engineer or Engineer's representative. The Contractor shall notify the Engineer before noon of the working day before inspection is required. Work inspection shall be done only in the presence of the Engineer, unless otherwise authorized. Any work done without proper inspection will be subject to rejection. The Engineer and any authorized representatives shall at all times have access to the work during its construction at shops and yards as well as the project site. The Contractor shall provide every reasonable facility for ascertaining that the materials and workmanship are in accordance with these specifications. Inspection of the work shall not relieve the Contractor of the obligation to fulfill all conditions of the Contract.

SP 200. SURFACING SPECIALS

SP 201. CONCRETE MIX

Concrete shall be NDOT 47B-3500 or 47B-3500HE, utilizing NDOT approved Type IP or IS cement, with a maximum water/cement ratio, air content range, minimum cementitious materials and total aggregates per Table 1002.02 as documented within the current NDOT 2017 Edition of Nebraska Dept. of Transportation Standard Specifications for Highway Construction.

All materials contained in the concrete mix design shall be from NDOT approved product list and shall conform to material requirements (including aggregates) as specified in the NDOT specifications.

SP 202. SUBGRADE PREPARATION

The subgrade shall be prepared according to the recommendation within the Report of Geotechnical Exploration for this project located in the appendix. To prepare the subgrade, the top 6-12 inches (as indicated in the typical sections) of the subgrade should be scarified and re-compacted to a minimum of 98 percent of the maximum dry density as determined by ASTM D698, Standard Proctor. The moisture content shall be between -1 and +3 percent of optimum content as determined by ASTM D698 Standard Proctor.

SP 203. DOWEL AND TIE BARS

Dowel bars shall be plain **epoxy coated** steel bars conforming to ASTM A615 or ASTM A996 and shall be free from burring or other deformation restricting slippage in the concrete. Before delivery to the construction site each dowel bar shall be epoxy coated per ASTM A775. The dowels shall be coated with a bond-breaker recommended by the manufacturer. Grout retention rings shall be fully circular metal or plastic devices capable of supporting the dowel until the epoxy hardens. Dowel sleeves or inserts are not permitted.

Tie bars shall be deformed **epoxy coated** steel bars and conform to the requirements of ASTM A615 or ASTM A996, except that rail steel bars, Grade 60, shall not be used for tie bars that are to be bent or re-straightened during construction. Tie bars designated as Grade 40 in ASTM A615 can be used for construction requiring bent bars.

SP 204. FOUNDATION COURSE

Foundation base course layer shall be placed under Concrete Pavement as indicated on the plans consisting of aggregate course – D or crushed concrete. Bituminous Millings will not be allowed. Foundation course shall be in accordance with NDOR Standard Specification for Highway Construction Section 307. The Engineer reserves the right to increase or decrease this quantity any amount based on field conditions during construction.

SP 205. SIDEWALK RAMPS

Sidewalk ramps, as indicated within the construction plan details, are not specifically called out as a separate item of measurement and payment within the construction drawings. 47B-3500 concrete, thickened concrete to match adjacent roadway and/or driveway depths and expansion joint material shall be considered incidental to the measurement and payment of sidewalk construction.

SP 206. TEMPORARY CRUSHED ROCK SURFACE COURSE

Temporary crushed rock surface course shall be provided as shown on the plans or as directed by the Engineer to provide temporary access. The crushed rock surface course shall meet NDOT specifications.

Payment for temporary rock surfacing shall be paid for at the contract unit price bid per ton "Temporary Crushed Rock Surface Course". Such payment shall be full compensation for all labor, equipment and material required to furnish, place, and remove the temporary rock at the locations shown on the plans or as directed by the Engineer. Removal of the

Temporary rock to allow construction of the new pavement or grading adjacent to the roadway shall not be paid for directly and these costs shall be included in the price bid per ton for the temporary rock surface course.

SP 207. SPRINKLER REPAIR

The Work described in this section shall pertain to any sprinkler repair work on each separate landowner property completed by an "Irrigation Subcontractor". Work shall include all labor, materials and equipment as well as obtaining all tap fees, permits, etc. as may be required to complete the sprinkler repair or extension of the system to sprinkle all sodded properties. Materials shall match existing sprinkler system brands for each landowner property or approved equal by the City's Project Manager prior to installation.

The Contractor and/or Irrigation Subcontractor shall locate, flag and protect lawn sprinkler systems to the best of their ability and repair any portion of a lawn sprinkler system that are damaged by said work operations. No direct payment will be made for locating, flagging and protecting sprinkler systems, and it shall be considered subsidiary to other items for which direct payment is made, however, when lawn sprinklers are damaged and repairs are necessary as a result of the work, it shall be approved by the Project Manager prior to completion by an Irrigation Subcontractor.

When the Irrigation subcontractor is satisfied that the system is operating properly and that all Work and cleanup is completed, the Subcontractor shall notify the City's Project Manager that the Work is prepared for Final Inspection. At the given time, the sprinkler system with repairs will be inspected for acceptance.

Payment for sprinkler repair shall be paid for by contract lump sum unit price "Sprinkler Repair". This lump sum price shall include repairing and extending existing sprinkler systems for all properties identified to be sodded in the project plans.

SP 208. RECONSTRUCT MANHOLE

This work is for reconstructing a manhole when a manhole cannot be adjusted utilizing risers. The contractor will be required to remove the cone section of the manhole and adjust the manhole by removing, adding, or replacing a manhole barrel section. If adjustment can not be achieved by removing a barrel section of the manhole. The cone section shall be replaced with a flat manhole deck section. This work shall include contractor investigating each manhole and providing a shop drawing of the reconstructed manhole. Shop drawing shall be approved by the engineer prior to the work being completed.

SP 300. STORM SEWER AND UTILITY SPECIALS

SP 301. MANHOLE STEPS

In lieu of Deeter No. 1603 cast iron steps, the manholes shall be furnished with Copolymer Polypropylene Plastic PSI-PF manufactured by M.S. Industries, Inc., or approved equal.

SP 302. PRECAST STORM SEWER MANHOLE, CURB AND AREA INLET

Precast concrete manhole and inlet structures are and acceptable alternate to casting in place. Precast manhole and inlet structures shall be manufactured in accordance with ASTM-C913. The inverts of the box shall be cast in the field. The structures shall be set with a 6" minimum foundation course. The foundation course shall be considered subsidiary to the structure.

A detailed shop drawing shall be submitted for the structures by a certified precast facility to the engineer for review prior to production. Contractor will still be responsible for constructability and verification of the dimensions of the shop drawings. No additional payment will be allowed field adjustments of the structures, this shall include adjustments required for accommodation of existing utilities or any other existing condition or paving operations.

SP 303. PRIVATE INLET

For private inlets identified in the plans, an alternate ADS Nyloplast Curb Inlet is an acceptable alternate. The inlet shall be installed according to the detail in the plans and manufacture specifications. Any pipe adaptors shall be considered subsidiary.

A detailed shop drawing shall be submitted for the structures for review prior to production. Contractor will still be responsible for constructability and verification of the dimensions of the shop drawings. No additional payment will be allowed for field adjustments of the structures, this shall include adjustments required for accommodation of existing utilities or any other existing condition or paving operations.

SP 304. MOISTURE AND DENSITY REQUIREMENTS – TRENCHES

Each layer of embankment and backfill material shall be compacted to 98%. Water required shall be sufficient to obtain optimum moisture content shall be in the range of minus 1% to plus 3%. Cost of Contractor's compaction, rolling, and watering is incidental to the work.

SP 305. TV INSPECTION

The TV inspection will be completed after thirty (30) days has elapsed of sewer line construction completion, and discontinuance of dewatering. Final payment for sewer line construction will not be made until after completion of TV inspection and repair of any defects found.

Television inspection for the various gravity sewers will be performed by the City Wastewater Division. The City's Wastewater Division shall perform the 1st television inspection free of charge. If any additional television inspections are required due to construction issues with the sewer line the City will bill the Contractor for such services based on the current fee schedule for Television inspections. The 2022-2023 fee schedule for Television Inspection is \$1.50 per linear foot with a minimum billable fee of \$100.00. Re-inspections and Contractor special requests shall be billed accordingly.

The sanitary/storm sewer Contractor is responsible for cleaning of all sewer lines prior to testing. No soil or debris shall be allowed to be flushed downstream. No additional payment shall be made to the contractor for this testing and these costs shall be considered subsidiary to applicable pipe installation bid items.

SP 306. DEWATERING

The water table on this project may require dewatering of the trenches or excavation areas for construction of storm sewers, sanitary sewers, water main, or other underground utilities. The Contractor is responsible for devising and operating a construction dewatering system, if required.

The City of Grand Island has a Construction Dewatering Permit from the State of Nebraska Department of Environmental Control. A copy of permit number NEG671000 can be obtained from the City.

All dewatering discharge water shall be conveyed to locations approved by the City. It will be the Contractor's responsibility to make driveway and street crossings in such a manner as to not interfere with normal use. The Contractor will not be allowed to utilize the right-of-way ditches for open conveyance of discharge water. Restoration of disturbed areas is required.

The project will require the Contractor to ensure compliance with all aspects of the National Pollutant Discharge Elimination System (NPDES) General NPDES Permit Number NEG671000 for Dewatering Discharges. The Contractor shall ensure all provisions of the permit are followed: field samples, submittals to Notice of Intent (DW-NOI), checklists, Discharge Monitoring Report (DW-DMR), Physical Characteristic Examination Report (PCE), and any Non-Compliance Reports.

All documentation on the dewatering operations shall be recorded and archived by the Contractor for the duration of the project. The acquired field grabs or composite sampling, and flow measurement of dewatering discharges shall be the responsibility of the Contractor. The City shall provide the sample bottles and lab work in testing pH, Total Petroleum Hydrocarbons, and Total Suspended Solids. The Contractor shall work jointly with the City's lab representative in scheduling testing at the Wastewater Treatment Plant.

The City shall be copied on all documentation and reports.

If dewatering wells are used, the Contractor is required to secure all permits, and properly fill and abandon the wells after use as per State Statutes.

Dewatering discharge location and allowable discharge volume shall be coordinated with the City of Grand Island and Engineer. The Contractor shall implement a best management plan for erosion mitigation measures.

SP 307. FOUNDATION COURSE - STRUCTURES

Foundation base course layer shall be placed under structures as indicated on the plans or as directed by the engineer consisting of aggregate course – D or crushed concrete. Bituminous Millings will not be allowed. Foundation course shall be in accordance with NDOR Standard Specification for Highway Construction Section 307.

SP 400. GRADING, AND REMOVAL SPECIALS

SP 401. REMOVE AND RESET MAILBOX

The Contractor shall remove and reset mailbox as indicated on plans and shall use care while removing, storing and resetting the mailbox. Any damage to the material shall be replaced in kind with like materials at the cost of the Contractor. During construction, a temporary mailbox shall be installed per guidance from the "Postmaster" that delivers mail to the area at each residence as indicated within the plans.

Removal of concrete footings at mailboxes shall not be paid for directly but shall be considered part of the work for the removal and resetting of the mailbox. Payment for the removal and resetting of mailboxes shall be paid for at the contract unit price bid per each for the pay items "Remove & Reset Mailbox." This shall be full compensation for all labor, supplying posts, equipment, and material required for removal, disposal, back fill and compaction, and all other incidental items required to remove and relocate the mailboxes.

SP 402. REMOVE AND RESET COMMUNITY MAILBOX

The Contractor shall remove and reset mailbox as indicated on plans and shall use care while removing, storing and resetting the mailbox. Any damage to the material shall be replaced in kind with like materials at the cost of the Contractor. During construction, a temporary mailbox shall be installed per guidance from the "Postmaster" that delivers mail to the area at each residence as indicated within the plans. Removal of concrete footings at mailboxes shall not be paid for directly but shall be considered part of the work for the removal and resetting of the mailbox. Payment for the removal and resetting of mailboxes shall be paid for at the contract unit price bid per each for the pay items "Remove & Reset Community Mailbox." This shall be full compensation for all labor, supplying posts, equipment, and material required for removal, disposal, back fill and compaction, and all other incidental items required to remove and relocate the mailboxes.

SP 403. REMOVE AND REPLACE EXISTING

Where it is necessary in the construction of this improvement to remove or disturb existing structures, landscaping, borders, fences, or other improvements, said structures, fences, or other improvements shall be stored, and restored promptly and to as good a condition as that existing prior to being disturbed. All trees, shrubs, gardens, lawns, drives and other such surface objects shall be protected and preserved as much as possible and where disturbed shall be replaced or repaired and left in as good condition as before the work was started. The Contractor shall not request additional compensation for such work.

SP 404. CLEARING AND GRUBBING

Clearing and grubbing of stumps, shrubs, trees (all sizes), and grasses shall be paid for at the contract unit bid price per lump sum for the pay item "Clearing and Grubbing". This work shall include, but not be limited to, the removal and disposal all stumps, shrubs, trees, and weeds within the limits of construction necessary for roadway construction.

SP 405. STRIPPING/SPREADING OF TOPSOIL

Topsoil shall be salvaged from areas requiring excavations where current vegetation exists (everywhere not paved) and it shall be stockpiled and replaced after construction. Topsoil shall consist of friable surface soil up to one foot (1') in depth, reasonably free of grass, roots, weeds, sticks, stones, and other objects. Topsoil shall be stockpiled after areas have been cleaned and grubbed.

Topsoil shall not be spread when the ground or topsoil is frozen, excessively wet or otherwise in a condition detrimental to work. Surfaces designated to be covered shall be lightly scarified just prior to the spreading operation. Where compacted fill is designated to be covered by topsoil, the topsoil shall be placed concurrently with the fill and shall be bonded to the compacted fill with the compacting equipment.

No separate payment shall be made for salvaging and spreading topsoil. Salvaging and spreading topsoil shall be considered subsidiary to items for which separate payment is made.

SP 406. SURFACE AND UNDERGROUND DRAINAGE, UTILITIES, AND IRRIGATION

Where it is necessary in the prosecution of the work to interrupt existing surface drainage, temporary drainage facilities shall be provided and maintained at the Contractor's expense until permanent drainage facilities are completed. The Contractor shall be responsible for, and shall take all necessary precautions to protect and preserve any and all existing subsurface drains, conduits, utilities, and other underground structures, irrigation systems or parts thereof which may be affected by the construction, and which in the opinion of the Engineer may be properly continued in use without any change. The Contractor shall, at their own expense, repair all damage to facilities or structures which results from any of their operations or their negligence.

SP 407. EARTHWORK

Roadway and trail grading including general excavation and embankment construction shall be completed as shown on the plans. The Contractor shall strip and stockpile the existing topsoil for redistribution during final grading over areas to be sodded or seeded. All fills, and areas to receive surfacing shall be prepared and compacted to the minimum densities shown on the plans, special provisions, and geotechnical report.

Where feasible, any areas in the construction area to receive borrow should be proofrolled with a loaded dump truck, scraper, or similar rubber-tired equipment weighing at least 15 tons. Proofrolling should also be performed in areas requiring mass excavation after

rough finished subgrade elevation is achieved. Proofrolling operations should be observed by the Engineer. Unstable and unsuitable soils which are revealed by proofrolling, and which cannot be adequately densified in place, should be removed under the direction of the Engineer. It may be necessary to perform selective removal of soft, wet soils and/or stabilize existing soft soils in-place.

The recommendation generally provided during construction for dealing with surficial wet conditions would be to scarify the top 12 inches of soil and allow the soils to dry back to a moisture content suitable for obtaining the required compaction. This work shall be considered subsidiary to Earthwork item if required.

It shall be the Contractor's responsibility to ensure all roads and the roads adjacent to the construction site to provide safe conditions for the traveling public, to prevent environmental damage, to secure personal property, or to comply with local regulatory requirements. The Contractor shall maintain drainage for all temporary roadways and work sites at all times. When existing drainage facilities are severed or otherwise rendered inoperable, the Contractor shall construct as much of the designed drainage system as may be necessary to maintain adequate drainage. Temporary grading and/or ditching may also be required to maintain drainage. Any temporary grading and ditching that is required shall be completed as an incidental expense unless it is part of the designed project earthwork. All temporary drainage work shall be completed to the satisfaction of the Engineer.

Payment for general roadway grading including excavation and construction of embankments shall be paid for at the contract unit price bid per lump sum for the pay item "Earthwork". Below are approximate quantities:

Excavation = 2,200 CY

Embankment = 600 CY

These quantities shall be considered established quantities utilizing a balance factor of 1.0, and no additional measurement or compensation will be made. This work shall include all items of work associated with the general roadway and trail grading including stripping and stockpiling topsoil, furnishing off site borrow, disposal of excess excavated materials, hauling, placement, compaction, water required to achieve compaction, and final grading (including redistribution of topsoil).

SP 408. STRUCTURAL FILL

During construction, we recommend that fill materials have a liquid limit of less than 45, and a plasticity index of less than 25. Silty sand, clayey sand, and poorly graded sand would be suitable for structural fill material as well. Whenever possible, highly plastic silt (MH) or clay (CH) fill soils should not be placed within the upper 4 feet of the final ground elevation. Soils which have a liquid limit greater than 45 and a plasticity index greater than 25 will typically require removal or blending with less plastic materials to result in lower Atterberg limits.

In addition to the plasticity characteristics, the fill soils should also be relatively free of organic materials (less than about two hundredths by weight), other deleterious material and should not contain particle sizes larger than three inches. Imported fill material should be tested prior to placement at the site to verify it complies with the criteria stated in this section of the report. Samples of the proposed imported structural fill should be submitted at least three days prior to placement so the necessary laboratory tests can be performed.

Suitable fill material should be placed in thin lifts (lift thickness depends on type of compaction equipment, but in general, lifts of 8 inches loose measurement is recommended). The soil should be compacted by heavy compaction equipment such as a Caterpillar 815 sheepsfoot roller. Within small excavations, such as in utility trenches (less than 24 inches in width), around manholes or behind retaining walls, we recommend the use of "wacker packers", "Rammax" compactors, or vibrating plate compactors to achieve the specified compaction. Loose lift thickness of 4 inches are recommended in small area fills.

SP 409. OVEREXCAVATION

In areas as identified in the plans or as directed by the engineer, the contractor shall provide a uniform, compacted subgrade a minimum of two feet below the new roadway pavement base. The Contractor shall overexcavate 18" below the bottom of proposed pavement and scarify an additional 6" and re-compact. The suitable overexcavated material shall then be placed and re-compact. Additional material to bring subgrade to grade shall be obtained from other areas excavated on the project. This material below the base of the pavement in these areas should be compacted to a minimum of 98 percent of the maximum dry density as determined by ASTM-698, Standard Proctor, Moisture Density Relationship.

SP 410. REMOVAL & REPLACEMENT OF UNSUITABLE MATERIAL

The Contractor shall excavate and dispose of unsuitable materials that are encountered below areas to receive pavement and replace it with offsite borrow material as directed by the Engineer. Any imported fill materials shall meet the requirements of the structural fill section. The quantity of overexcavated material shall be measured based upon the field survey of the excavated area and the final grades and lines shown on the cross sections.

Payment for overexcavation of unsuitable material shall be made at the contract unit price bid per cubic yard for the pay item "Removal & Replacement of Unsuitable Material". This payment shall be full compensation for all excavation and removal of unsuitable material including disposal of unsuitable material and furnishing, placement and compaction of offsite borrow material to replace the unsuitable material as directed by the Engineer.

SP 411. SEEDING

Permanent seeding consists of furnishing and placing seed and fertilizer for all areas disturbed, not to be sodded or paved.

Seeding operations shall be performed only during the period's April 15 to June 15 and August 10 to October 15.

1. Site Preparation.

- a. Conduct a composite soil test, two per acre minimum, to determine fertilizer type and verify seed mixture compatibility. This shall include checking PH.
- b. Remove debris.
- c. Eliminate existing vegetation. Spray with a non-selective herbicide if vegetation exists. Remove any excess dead vegetation.
- d. The seedbed shall be prepared with a three (3) inch surface layer that will be loose enough to allow satisfactory penetration of the mulch-anchoring machine. Disking, harrowing, and raking shall be longitudinal on all slopes.
- e. The Contractor shall contact the Engineer to inspect the seedbed prior to seeding.

2. Fertilize

- a. An agronomist approved fertilizer type shall be submitted to the Engineer for review.
- b. Apply fertilizer at application rate recommended by soil analysis after smooth raking of the topsoil
- c. Do not apply fertilizer at the same time or with same machine used to apply seed.
- d. Mix fertilizer thoroughly into upper 2 inches of the topsoil.
- e. Lightly water soil to aid dissipation of fertilizer. Irrigate top level of soil uniformly.

3. Seeding.

- a. The grass mixture to be furnished shall be uniformly drilled on all areas accessible to machinery. On areas not accessible to machinery, the seed may be uniformly broadcast, and will be covered by use of a harrow.
- b. Seed should be planted 0.125 to 0.25 inches below the soil surface.
- c. Plant two directions putting ½ of seed down each direction
- d. Gently roll or rake seeded area to ensure good soil to see contact.
- e. Do not seed areas in excess of that which cannot be mulched within 24 hours.
- f. Do not sow immediately following rain, when ground is too dry, or when winds are over 10 mph.

4. Seed Mixture

The seed mixture shall be Arrow Seed Co., Inc Type B Mixture or approved equivalent. An agronomist and engineer shall review the mix for compatibility with the top soil and fertilizer. Seed mixture application rates are as follows:

| <u>Species</u> | <u>*Pure Live Seed/Acre</u> |
|---------------------------|---------------------------------|
| Linn Perennial ryegrass | 8 lbs. |
| K-31 Tall fescue | 12 lbs. |
| Quatro Sheep fescue | 5 lbs. |
| Barton Western wheatgrass | 6 lbs. |
| Cody Buffalograss | 5 lbs. |
| VNS Blue grama | 3 lbs. |
| VNS Oats | 12 lbs. |

***Rates shown are for drilling. Rates shall be doubled for broadcast seeding.**

All seed shall be origin Nebraska, adjoining states, or as specified. A Contractor proposing to use a substitute variety, or origin shall submit for the Engineer's consideration a seed tag representing the seed which shows the variety, origin and is of the seed.

SP 412. HYDROMULCHING

This work consists of furnishing and placing hydromulch on areas to be seeded. Hydromulch shall be NDOT Type HM2, wood mulch with tackifier.

The Contractor shall apply the hydromulch within 24 hours after planting the seed. The hydromulch shall be applied uniformly with a hydromulch machine at an application rate of 1.5 tons per acre. To ensure complete and uniform coverage, the Contractor shall apply the hydromulch from opposing directions to prevent shadowing or as directed by Engineer. The weight of hydromulch applied will be computed on the basis of the weight per bag multiplied by the number of bags used. The Contractor shall provide documentation of the number of bags used and shall be verified by the Engineer.

The Contractor shall refer to the manufacturer's recommendations for appropriate matrix to water ratios. All necessary water required for hydromulching shall be considered subsidiary.

SP 413. WATERING

This work shall include watering seeded areas to get established. Prior to watering the Contractor shall notify the engineer for approval to proceed. Each watering the contractor shall apply a minimum of 1/4" of water evenly distributed across the entire seeded area. The contractor shall meter the number of the gallons applied to be

verified by the Engineer. This item will be paid by the "Acre" to apply a 1/4" of water on an area.

SP 414. EROSION CONTROL MAT

Erosion control blanket shall be installed as noted in the plans or as directed by the Engineer. The straw erosion control blanket shall be S75 as manufactured by North American Green, or equivalent. The straw erosion control blanket shall be a machine-produced mat with a one hundred (100) percent agricultural straw matrix. The blanket shall be of consistent thickness with the straw evenly distributed over the entire area of the blanket. The blanket shall be covered on the top with polypropylene netting having an approximate 0.63 inch by 0.63-inch mesh. Breakdown of the netting within approximately twelve (12) months, depending on geographic location and elevation. The blanket shall be sewn together on 1.50-inch centers with degradable thread. Installation staple patterns shall be clearly marked on the erosion control blanket with environmentally safe paint. The blanket shall be manufactured with a colored line or thread stitched along both outer edges (approximately two to five inches from the edge) to ensure proper material overlapping.

The erosion control blanket shall have the following properties: density of 0.50 lb./yd.²; the netting, topside 1.5 lb./1000 ft.², and the thread shall also be degradable.

Installation as per manufactures printed literature.

SP 415. EROSION CONTROL ITEMS

All erosion control shall be NDOT approved products.

SP 500. PAVEMENT MARKINGS AND SIGNAGE

SP 501. SIGNS.

Signs shall be in accordance with and installed per NDOT Standard Specifications for Highway Construction – Section 417. Paragraph 1 of Subsection 417.05 in the Standard Specifications is amended to include the following:

| Pay Item | Pay Unit |
|------------------|-----------------|
| Roadway Sign | Each (ea.) |
| Street Name Sign | Each (ea.) |

Sign Layout for Signal Street name signs shall be approved by the City of Grand Island Public Works Department prior to ordering.

Existing signs shall be removed and salvaged to the City. This work shall be considered subsidiary to construction.

Post used shall also be amended to the following:

SP 502. TELESPAR SIGN POST

Sign post shall include Telespar, 2” square, 12 gauge post, Telespar 2-1/4” OD x 36”, 12 gauge anchor and hardware required to install sign on post.

The item “Telespar Sign Post” shall be measured and paid for by each. Payment shall be considered full compensation for all work required to furnish and install the Telespar sign post.

SP 600. MEASUREMENT AND PAYMENT

1. Mobilization. Shall include all costs for bonding and insurance, establishing temporary facilities, as required, temporary fencing, job trailers, prospecting for and exposing existing utilities, moving construction equipment and materials to and from the site, installation, start-up, and all appurtenances related to the work not otherwise specifically called out. The pay item is lump sum, with an equitable amount to be withheld until demobilization after final completion of the work. The pay item is one (1) lump sum.
2. Concrete Pavement. The measurement and payment for this item will be the actual number of square yards of concrete placed and accepted; including forming, reinforcement, reinforcing chairs or supports, concrete, doweling; curing compounds; contraction and expansion joints where required, including partial depth sawcuts; joint sealing compounds; concrete additives; finishing and edging; furnishing, transporting, installing, and compaction of all materials required for a stable subbase; subgrade preparation according to soils report for parking lots (separate item for roadway subgrade preparation); and all other related and necessary materials, work and equipment required to construct the pavement. Any panels that contain random cracking will be considered unacceptable. The engineer will decide whether to replace or repair the panel. The contractor shall replace or repair these panels at the direction of the engineer at no cost to the owner. A 20% deduction will be assessed on a repaired panel. Any panel that is replaced will not be assessed a 20% deduction. The pay item is one (1) square yard.
3. Concrete Driveway. shall include all labor, materials, equipment, unclassified excavation, backfill, subgrade preparation, compaction, Portland Cement concrete, formwork, finishing, jointing, expansion materials, joint sealant, saw cutting, and incidental items for placing Portland Cement concrete driveways all in accordance with the plans and specifications. The pay item is one (1) square yard constructed.
4. Concrete Sidewalk. shall include all labor, materials, equipment, unclassified excavation, backfill, subgrade preparation, compaction, Portland Cement concrete, formwork, finishing, jointing, expansion materials, joint sealant, saw cutting, construction of handicap ramp, and incidental items for placing Portland Cement concrete sidewalk all in accordance with the plans and specifications. The pay item is one (1) square yard constructed.
5. Detectable Warning Panel. Shall include all necessary materials, labor, joint sealers, finishing, and all subsidiary items of work for Detectable Warning Panels, in accordance with the plans and specifications. The pay item is per one (1) square foot.

6. Storm Sewer Manhole. Shall include all labor, materials, equipment, removal and disposal of excavated materials backfill with approved materials, compaction, bedding, concrete, castings, formwork, reinforcement, cast iron frame and covers, concrete risers, and incidental items for constructing a storm sewer manhole all in accordance with the plans and specifications. The pay item is one (1) each.
7. Storm Sewer Curb Inlet and Area Inlet. Shall include all labor, materials, equipment, removal and disposal of excavated materials backfill with approved materials, compaction, bedding, concrete, castings, formwork, reinforcement, cast iron frame and grate and covers, concrete risers, and incidental items for constructing structures all in accordance with the plans and specifications. The pay item is one (1) each.
8. Storm Sewer Collar. Shall include all labor, materials, equipment, backfill, compaction, fine grading, roofing felt paper, reinforcement, concrete, and incidental items for constructing a storm sewer concrete collar all in accordance with the plans and specifications. The pay item is one (1) each.
9. Reinforced Concrete Storm Sewer Pipe. Shall include all labor, materials, equipment, hauling, delivery, joint material, RC storm sewer pipe, unclassified excavation, backfill, bedding, sand backfill to springline, and incidental items for constructing storm sewer pipe of the type(s) and sizes(s) listed on the bid form and shown on the plans and specifications. The pay is one (1) linear foot of RC storm sewer pipe installed.
10. Reinforced Concrete Flared End Section. Shall include all labor, materials, equipment, hauling, delivery, joint material, RC FES, unclassified excavation, backfill, subgrade preparation, and incidental items for constructing storm flared end section of the type(s) and sizes(s) listed on the bid form and shown on the plans and specifications. The pay is one (1) each of RC flared end section installed.
11. Reconstruct Manhole. Shall include all labor, materials, equipment, backfill, compaction, fine grading, concrete, castings, formwork, reinforcement, lids, gaskets, manhole barrel sections, manhole concrete deck (if required) and incidental items to reconstruct a manhole all in accordance with the plans and specifications. The pay item is one (1) each.
12. Adjust Manhole to Grade. shall include all labor, materials, equipment, adjusting rings, backfill, Portland Cement concrete slab around manhole casting, forming, finishing, and incidental items for adjusting manhole to proposed pavement grade all in accordance with the plans and specifications. The pay item is one (1) each.

13. PVC Sanitary Sewer Service Pipe. shall include all labor, materials, equipment, hauling, delivery, joint material, PVC sanitary sewer service pipe, unclassified excavation, backfill, subgrade preparation, and incidental items for constructing sanitary sewer service pipe of the type(s) and sizes(s) listed on the bid form and shown on the plans and specifications. The pay is one (1) linear foot of PVC sanitary sewer service pipe installed.
14. PVC Sanitary Sewer Plug. Shall include all labor, material, equipment, unclassified excavation, testing, backfill and all necessary incidental items for furnishing and installing sewer plugs as specified and as shown on the drawings. The pay item is one (1) each for type of tee specified.
15. Connect to Existing Sewer Service. Shall include all labor, miscellaneous fittings, materials, equipment, unclassified excavation, testing, backfill, and incidental items for connecting to existing service as specified and as shown on the drawings. The pay item is one (1) each.
16. D.I. Water Main. Shall include all labor, materials, equipment, unclassified excavation, subgrade preparation, pipe installation with rubber gasket joints, lubricant, reaction blocking, thrust restraints, tracer wire, disinfection, testing, backfill, trench compaction, dewatering, fittings, and incidental items for installing ductile iron water main of the size(s) listed on the bid form and shown on the plans, all in accordance with the plans and specifications. The pay is one (1) linear foot.
17. Fire Hydrant Assembly, Type 1. Shall include all labor, materials, excavation, equipment, backfill, grading, fire hydrant, fittings, valve, valve box, thrust block, retainer glands, and incidental items for installing type 1 fire hydrant assembly all in accordance with the plans and specifications. The pay item is one (1) each.
18. Fire Hydrant Assembly, Type 2. Shall include all labor, materials, excavation, equipment, backfill, grading, fire hydrant, fittings, valve, valve box, thrust block, retainer glands, and incidental items for installing type 2 fire hydrant assembly all in accordance with the plans and specifications. The pay item is one (1) each.
19. Ductile Iron Fittings. Shall include all labor, material, equipment, unclassified excavation, thrust restraints, testing, disinfection, backfill and all necessary incidental items for furnishing and installing ductile iron fittings as specified and as shown on the drawings. The pay item is one (1) pound of ductile iron fitting.
20. Tapping Sleeve and Valve. Shall include all labor, equipment, unclassified excavation, disinfection, testing, backfill, extension rod, City charges, valve boxes and incidental items for furnishing and placing applicable sized tapping sleeve and valves listed in the bid form all in accordance with the plans and specifications. The pay item is one (1) each.
21. M.J. Gate Valve with Box. Shall include all labor, equipment, unclassified

- excavation, disinfection, testing, backfill, extension rod, and incidental items for furnishing and placing applicable sized gate valves and valve boxes listed in the bid form all in accordance with the plans and specifications. The pay item is one (1) each.
22. I-Beam Block. Shall include all labor, material, equipment, unclassified excavation, reinforcement, I-beam, concrete, forming, backfill and all necessary incidental items for constructing an I-beam block as specified and as shown on the drawings. The pay item is one (1) each for type of fitting specified.
 23. Corporation Stop. Shall include all labor, miscellaneous fittings, materials, equipment, unclassified excavation, testing, disinfection, backfill, and incidental items for installing corporation stops of the size(s) as specified and as shown on the drawings. The pay item is one (1) each.
 24. Curb Stop. Shall include all labor, miscellaneous fittings, materials, equipment, unclassified excavation, testing, disinfection, backfill, and incidental items for installing curb stops and curb boxes of the size(s) as specified and as shown on the drawings. The pay item is one (1) each.
 25. Copper Service Tubing. Shall include all miscellaneous fittings, labor, materials, equipment, unclassified excavation, subgrade preparation, tunneling beneath minor obstructions or walks, open boring, backfill, testing, disinfection, and incidental items for furnishing and installing water service tubing of the type(s) and size(s) listed on the bid form as specified and as shown on the drawings. The pay item is one (1) linear foot.
 26. Reconnect Water Service. Shall include all labor, miscellaneous fittings, materials, equipment, unclassified excavation, testing, disinfection, backfill, and incidental items for connecting to existing service as specified and as shown on the drawings. The pay item is one (1) each.
 27. Testing and Sampling Tap. Shall include all labor, equipment, unclassified excavation, disinfection, testing, backfill, City charges, tap and incidental items for testing and sampling tap in accordance with the plans and specifications. The pay item is one (1) each.
 28. Remove and Salvage Hydrant. Shall include all labor, materials, excavation, equipment, removal, hoisting, hauling, salvage to City, and incidental items for removing an existing fire hydrant all in accordance with the plans and specifications. The pay item is one (1) each.
 29. Abandon Valve. Shall include all labor, materials, excavation, equipment, removal, hoisting, hauling, and incidental items for removing a valve box all in accordance with the plans and specifications. The pay item is one (1) each.
 30. Dewatering – Water Main. Shall include all labor, materials, equipment, wells, sand points, pumps, power, discharge piping, outlet structure, NPDES permit and associated requirements, and incidental work for the installation, operation,

- and maintenance, of a dewatering system for the installation of a water main in accordance with the plans and specifications. The pay item is one (1) lump sum.
31. Roadway & Street Name Sign. Shall be considered full compensation of this item required to professionally furnish and transport all materials and equipment as specified; install, and provide any other necessary materials, labor and equipment required to properly attach a sign to sign post all in accordance with the plans and specifications. The pay item is one (1) each.
 32. Telespar Sign Post. Shall be considered full compensation of this item required to professionally furnish and transport all materials and equipment as specified; provide proper hardware to attach sign to post; compact, level, and any other necessary materials, labor and equipment required to properly install a sign post all in accordance with the plans and specifications. The pay item is one (1) each.
 33. Permanent Barricade, Type III. Shall include all labor, materials, equipment, and incidental items for constructing a permanent barricade all in accordance with the plans and specifications. The pay item is one (1) each.
 34. Pavement Marking. The unit price bid per linear foot, or per each arrow, shall include all of the work including surface preparation and equipment, and all other related and necessary materials, required to professionally install pavement markings in type, size and material as shown on the plans. All gaps are not measured.
 35. Parking Lot Pavement Marking. Shall include all of the work including surface preparation and equipment, and all other related and necessary materials, required to professionally install parking lot pavement markings in type, size and material as shown on the plans. The pay item is one (1) lump sum.
 36. Reset Parking Lot Light Pole. Shall include, preparing, and reinstalling the existing lighting units; all necessary excavation, backfilling and disposal of surplus material; installing all internal wire and wiring devices, making all necessary electrical connections and for all labor, equipment, tools, materials and incidentals necessary to complete the work. The pay item is one (1) each for each complete unit removed and reinstalled.
 37. Remove Pavement. Shall include all labor, materials, equipment, unclassified excavation, breaking concrete/asphalt, saw cutting, hauling, disposal, backfill, grading, and incidental items for removing pavement all in accordance with the plans and specifications. The pay item is one (1) square yard.
 38. Remove Sidewalk. Shall include all labor, materials, equipment, unclassified excavation, breaking concrete, saw cutting, hauling, disposal, backfill, grading, and incidental items for removing sidewalk all in accordance with the plans and specifications. The pay item is one (1) square yard.

39. Remove Storm Sewer Manhole, Inlet and Flared End Section. Shall include all labor, materials, equipment, demolition, removal, hoisting, hauling, disposal, and incidental items for removing an existing storm sewer manhole, inlet and flared end section all in accordance with the plans and specifications. The pay item is one (1) each.
40. Remove Storm Sewer Pipe. Shall include all labor, materials, excavation, equipment, demolition, removal, hoisting, hauling, disposal, and incidental items for removing an existing storm sewer pipe all in accordance with the plans and specifications. The pay item is one (1) linear foot.
41. Remove and Salvage Light Pole. Shall include, removing, salvaging, storing and/or delivering the existing lighting units; all necessary excavation, backfilling and disposal of surplus material; and for all materials, labor, equipment, tools and incidentals necessary to complete the work. The pay item is one (1) each for each complete unit removed, accepted by the engineer and delivered to the city stock in Grand Island or stored on-site for placement.
42. Remove and reset community mailbox. Shall include labor, materials, equipment, excavation, protection from damage, footing, base preparation, backfill, compaction, coordination with US Postal Service on correct installation and incidental items necessary to temporarily remove and reset existing community mailbox(s). The pay item is one (1) each.
43. Remove and Reset Mailbox. Shall include labor, materials, equipment, excavation, protection from damage, footing, base preparation, backfill, compaction, coordination with US Postal Service on correct installation and incidental items necessary to temporarily remove and reset existing mailbox(s). The pay item is one (1) each.
44. Sodding. Shall include all labor, materials, equipment, sod bed preparation, fertilizer, and incidental items for furnishing and establishing sod to all disturbed areas as directed by the Engineer and as shown in the plans. The pay item is one (1) square yard.
45. Seeding. Shall include all labor, materials, equipment, soil test, seed bed preparation, fertilizer, and incidental items for furnishing and sowing grass seed and establishing seed to all disturbed areas as directed by the Engineer, and as shown in the plans. The pay item is one (1) acre.
46. Hydromulch. Shall include all labor, materials, equipment, mulch, water, and incidental items for furnishing and placing hydromulch on seeded areas as directed by the Engineer, and as shown in the plans. The pay item is one (1) ton. The weight of hydromulch applied will be computed on the basis of the weight per bag multiplied by the number of bags used. The Contractor shall provide documentation of the number of bags used and shall be verified by the Engineer.
47. Watering. Shall include all labor, water, equipment, and incidental items for

- watering seeded as approved by the Engineer. Each watering the contractor shall apply a minimum of ¼" of water evenly distributed across the entire seeded area. The contractor shall meter the number of the gallons applied to be verified by the Engineer. The pay item is one (1) acre to apply a minimum of ¼" of water on an area.
48. Erosion Control Mat. shall include all labor, materials, equipment, staples, ties, straps, mat, installation, upkeep, maintenance, and incidental items necessary to furnish, install, and maintain erosion control mat to establish seeded areas and mitigate erosion during construction. The pay item is one (1) square yard.
 49. Erosion Control Linear. shall include all labor, materials, equipment, posts, staples, ties, straps, silt fence, wattles, installation, upkeep, maintenance, and incidental items necessary to furnish, install, and maintain silt fence to prevent sediment from collecting outside of the work area during construction. The pay item is one (1) linear foot.
 50. Inlet Sediment Filters. Shall include all labor, equipment, materials, unclassified excavation, installation, maintenance, disposal, disposal fees, cleanup, and incidental items necessary for the placement of silt fence and sediment filter to prevent sediment from collecting in the storm sewer system during construction, maintenance of the silt fence and sediment filter, removal of silt fence and sediment filter when no longer necessary, for Inlet Protection all in accordance with the plans and specifications. The pay item is one (1) each.
 51. Cover Crop Seeding. Shall include all labor, materials, equipment, seed bed preparation, fertilizer, mulch, watering, and incidental items for furnishing and sowing cover crop seed and establishing seed to all disturbed areas as directed by the Engineer, and as shown in the plans. The pay item is one (1) acre.
 52. Sprinkler Repair. Shall include all labor, materials, equipment, installation, sprinkler heads, sprinkler lines, sprinkler valves, sprinkler fittings, relocating, setting sprinkler head rotation, backfill, excavation, compaction, and incidental items for sprinkler repair and extension of existing systems for all properties identified to be sodded in the plans and in accordance with the specifications. The pay item is one (1) lump sum.
 53. Temporary Traffic Control. Shall include all labor, materials for furnishing signs, sign supports, barrels, cones, barricades, installing, hauling, relocation and maintenance, removal, and incidental items to furnish, install, maintain, and removal a temporary traffic control. The pay item is one (1) lump sum.

54. Temporary Crushed Rock Surface Course. Shall include all necessary materials, labor, equipment, formwork, jointing, aggregate meeting NDOT specifications for crushed rock surface course, removal of temporary surfacing, hauling, placement, finishing, rough grading, subgrade preparation, and all subsidiary items of work for constructing Temporary Crushed Rock Surface Course, in accordance with the plans and specifications. The pay item is per one (1) ton.
55. Foundation Course – Structures. Shall include all necessary materials, equipment, hauling, loading, placement, compaction, and all subsidiary items of work for placing Foundation Course for roadway subgrade as identified in the places or as approved by the Engineer in the field. The pay item is per one (1) ton.
56. Foundation Course – Roadway. Shall include all necessary materials, equipment, hauling, loading, placement, compaction, including soil removal, soil hauling, and disposal, and all subsidiary items of work for Foundation Course, in accordance with the NDOT standard specifications, in place identified in the field with the Engineer. The pay item is per one (1) ton for pavement placed with foundation course. The Engineer reserves the right to increase or decrease this quantity any amount based on field conditions during construction.
57. General Clearing and Grubbing. Shall include labor, materials and equipment for the removal and disposal of trees, hedges, stumps, fences, and debris as found on the site within the limits of work. This pay item shall also include the general clearing and grubbing all in accordance with the plans and specifications. The pay unit is one (1) lump sum.
58. Subgrade Preparation. Shall include all necessary materials, soil, labor, equipment, hauling, loading, compaction, grading, and all subsidiary items of work for Subgrade Preparation, in accordance with the plans and specifications. The quantity for payment of Subgrade Preparation will be the number of overlying square yards of pavement, including intersections. The areas outside the plan typical cross sections, except intersections, will not be measured for payment but shall be considered subsidiary to “Subgrade Preparation”. The pay item is per one (1) square yard.
59. Over-excavation. Shall include labor, materials, equipment, and incidental items for excavation to a depth of 18” below the proposed pavement, scarifying, and backfilling to the bottom of the foundation course. The pay item is one (1) cubic yard. This quantity may decrease if unsuitable material is encountered and paid for as Removal & Replacement of Unsuitable Material.

60. Removal & Replacement of Unsuitable Material. Shall include labor, materials, equipment, and incidental items compensation for all excavation and removal of unsuitable material including disposal of unsuitable material and furnishing, placement and compaction of offsite borrow material to replace the unsuitable material as directed by the Engineer. The pay item is one (1) cubic yard. The Engineer reserves the right to increase or decrease this quantity any amount based on field conditions during construction.
61. Earthwork. Shall include all labor, materials, equipment, excavation, borrow, backfilling, and incidental items for excavation or embankment. This item shall also include transportation to haul excess material away from the site, and the importing/placing of suitable fill material all in accordance with the plans and specifications. The approximate quantities of cut and fill are shown on the plans and special provisions. The pay item is one (1) lump sum.



DIVISION II

PORTLAND CEMENT CONCRETE PAVEMENT

**DIVISION II
PORTLAND CEMENT CONCRETE PAVEMENT**

C O N T E N T S

| Section | Description |
|-----------|---|
| 10 | SCOPE OF WORK |
| 11 | MATERIALS |
| 11.04 | Cement--47-B (Modified) and ABX (Modified) Concrete |
| 11.02 | Portland Cement |
| 11.03 | Mixing Water |
| 11.04 | Fine Aggregate for 47-B (Modified) Concrete |
| 11.05 | Coarse Aggregate for 47-B (Modified) Concrete |
| 11.06 | Aggregate for ABX (Modified) Concrete |
| 11.07 | Granular Foundation Course |
| 11.08 | Joint Filler |
| 11.09 | Joint Sealing Material |
| 11.10 | Curing Compound |
| 12 | CONSTRUCTION METHODS |
| 12.01 | Clearing and Grubbing |
| 12.02 | Site Preparation |
| | Revised 1-18-2010 |
| 12.03 | Subgrade Preparation |
| 12.04 | Water Main and Sanitary Sewer Pipe Bedding and Backfill |
| 12.05 | Granular Foundation Course |
| 12.06 | Surplus Earth |
| 12.07 | Adjustment of Manholes |
| | Revised 1-18-2010 |
| 12.08 | Adjustment of Storm Sewer Inlets |
| 12.09 | Integral Curb |
| 13 | CONCRETE CONSTRUCTION |
| 13.01 | Forms and Form Setting |
| 13.02 | Air Entraining |
| 13.03 | Consistency |
| 13.04 | Mixing |
| 13.05 | Placing and Finishing |
| 13.06 | Surface Test |
| 13.07 | Headers |
| 13.08 | Transverse Construction Joints |
| 13.9 | Transverse Expansion Joints |
| 13.10 | Transverse Contraction Joints |
| 13.11 | Longitudinal Joints |
| 13.12 | Curing |
| 13.13 | Sealing of Joints |
| 13.14 | Protection |
| 13.15 | Opening to Traffic |
| 13.16 | Acceptance |

| Section | Description |
|-----------|---|
| 14 | METHOD OF MEASUREMENT AND BASIS OF PAYMENT |
| 14.01 | Clearing and Grubbing |
| 14.02 | Site Preparation |
| 14.03 | Grading, Surplus Earth, Embankment |
| 14.04 | Granular Foundation Course |
| 14.05 | Manholes |
| 14.06 | Storm Sewer Inlets |
| 14.07 | Integral Cub |
| 14.08 | Concrete Pavement |
| 14.09 | Beams |
| 14.10 | Headers |
| 14.11 | Transverse Expansion and Miscellaneous Joints |
| 14.12 | Concrete Test Cylinders |
| 14.13 | Testing |
| 14.14 | Miscellaneous |

**DIVISION II
PORTLAND CEMENT CONCRETE PAVEMENT**

SECTION 10 - SCOPE OF WORK

The work covered by this division of the specifications consists of furnishing all labor, plant, equipment, appliances, and materials and performing all operations necessary to construct and complete concrete pavement and appurtenances in strict accordance with these specifications, the applicable drawings, and subject to the terms and conditions of the contract.

SECTION 11 - MATERIALS

11.01 Cement - 47-B (Modified) and ABX (Modified) Concrete. The specifications for 47-B (Modified) and ABX (Modified) concrete shall be as specified in Section 1002 "Portland Cement Concrete" of the most current State of Nebraska Department of Roads Standard Specifications for Highway Construction with the following exceptions.

1. Paragraph 1 of Section 1002.04 is deleted and the following added:

For 47-B (Modified) concrete no more than 50 lbs. of total water will be added for each 100 lbs. of cement (water to cement ratio not to exceed 0.50). For ABX (Modified) concrete no more than 47 lbs. of total water will be added for each 100 lbs. of cement (water to cement ratio not to exceed 0.47).

Concrete with water to cement ratios greater than specified above will be rejected. If any water is added to the concrete at any time without the permission of the Engineer, the concrete will be rejected.

2. Portland Cement Concrete for pavement shall meet the following requirements:

| <u>Class of Concrete</u> | <u>Compressive Strength Requirements in Pounds per Square Inch</u> | |
|--------------------------|--|----------------|
| | <u>7 days</u> | <u>28 days</u> |
| 47-B (Modified) | 2100 | 3600 |
| ABX (Modified) | 2300 | 3800 |

11.02 Portland Cement. Shall be as specified in Section 1004 "Portland Cement" of the most current Nebraska Department of Roads specifications.

11.03 Mixing Water. Shall be as specified in Section 1005 "Water for Concrete" of the most current Nebraska Department of Roads specifications.

11.04 Fine Aggregate for 47-B (Modified) Concrete. Shall be as specified in Section 1033 "Aggregates", Table 1033.02A "Gradation Limits" of the most current Nebraska Department of Roads specifications.

11.05 Coarse Aggregate for 47-B (Modified) Concrete. Shall be as specified in Section 1033 "Aggregates", Table 1033.03A, of the most current Nebraska Department of Roads specifications.

11.06 Aggregate for ABX (Modified) Concrete. Shall be as specified in Section 1033 "Aggregates" of the most current Nebraska Department of Roads specifications with below noted additions.

It shall be the responsibility of the Contractor to submit test results conforming to ASTM C295 that indicate the aggregate to be used in ABX Modified concrete is non-reactive with the alkalis in cement. If the results of this test are not conclusive, then results shall be submitted that conform to ASTM C227 (Mortar Bar) which remove all doubt as to the acceptability of the aggregate for Portland cement concrete.

These results must be submitted prior to any concrete being used from any source of aggregate. New test results must be submitted each time the aggregate comes from a new source or for each 700 cubic yards of concrete poured.

In the event that non-reactive aggregate is not available, the Contractor will not be allowed to use the sand-gravel mix but will be required to use 47-B Modified Portland cement concrete as specified in these specifications under section entitled Cement - 47-B (Modified) and ABX (Modified) Concrete.

11.07 Granular Foundation Course. The granular materials shall be sand from local pits that are shown on the plans, or it may be a coarse sand, fine sand, loamy soil, or any mixture of any of these materials that conforms to the following requirements:

| | <u>Minimum</u> | <u>Maximum</u> |
|--------------------------------------|----------------|----------------|
| Total Percent Retained on #200 Sieve | 80 | 92 |
| Plasticity Index | | 6 |

11.08 Joint Filler. Joint filler shall consist of premoulded bituminous fiber uniformly impregnated with between 35% and 50% durable asphalt by weight and be furnished in strips of the dimensions specified in the plans. A one (1) inch thick sample when compressed to 50% of original thickness at rate of 1/10 inch per minute and released shall show at least 70% recovery within one hour after compression and shall not have required more than 500 pounds per square inch compression load and extrusion of not more than 1/8 inch.

11.09 Joint Sealing Material. The hot pour joint material shall be of the rubber-asphalt type and shall be melted in a double jacket kettle equipped with an agitator for stirring the material during melting and pouring. The rubber-asphalt shall meet Federal Specification SS-S-164 or subsequent revisions.

11.10 Curing Compound. The curing compound shall consist of a nonbituminous pigmented liquid conforming to AASHTO Designation M148-49 or subsequent revisions.

SECTION 12 - CONSTRUCTION METHODS

12.01 Clearing and Grubbing. Except for trees, shrubs, and grasses which are to be preserved as indicated on the plans or as designated by the Engineer, all trees, stumps, hedges, shrubs, weeds, grass, other herbaceous vegetation, and rubbish shall be removed from the right-of-way and from borrow pits furnished by the contracting authority. This work shall be classified as follows:

Clearing shall consist of the cutting, removal, and disposal of trees six (6) inches or more in diameter.

Grubbing shall consist of the removal and disposal of stumps, including roots.

Hedge removal shall consist of the pulling or grubbing and disposal of hedges or other shrubs planted close together in rows. If any individual tree of those composing a hedge has a diameter greater than four (4) inches, it shall be measured separately as a tree.

Weed and rubbish removal shall consist of the removal and disposal of all weeds, grass, other herbaceous vegetation, and all rubbish encountered on the work.

12.02 Site Preparation. This work shall consist of removal and disposal of all crosswalks, private walks, driveway approaches, curbs, curb and gutter, and headers as indicated on the plans or as directed by the Engineer.

Topsoil shall be carefully removed and deposited in storage piles convenient to the area which will subsequently receive topsoil. Topsoil shall be kept separate from other excavated materials and shall be piled free from roots, stones, and other undesirable materials.

The backfill over all existing utility lines shall be consolidated when shown on the plans or directed by the Engineer. This shall be done by water jetting and vibration to the full depth of the utility lines unless other methods are approved by the Engineer. When compaction over existing utility lines is not shown on the plans or is not a bid item and is directed to be done by the Engineer, the work shall be negotiated for in writing before any work is commenced and will be paid for as a single unit.

All sanitary and storm sewers will be televised before a street is paved or repaved to insure that the street will not have to be torn up to repair the sewer in the near future.

Revised 1-18-2010

12.03 Subgrade Preparation. All paving subgrade shall be brought to the exact lines, grades, and cross sections shown on the plans or as directed by the Engineer.

The subgrade shall be constructed to have a uniform density throughout its entire width. All soft or yielding material and other portions of the subgrade which will not compact readily shall be removed as directed. All hollow places, settlements, or other imperfections shall be filled with approved material and compacted.

In all places where embankment may be required to bring the subgrade to the required height, it shall be constructed in horizontal layers not to exceed six (6) inches in depth before rolling. Each successive layer of material placed as described shall be wetted to within 3% of the optimum moisture content and compacted to at least 95% of the maximum dry density obtained at optimum moisture content as determined by AASHTO Method T99.

In all embankment areas where highly expansive soils are encountered, materials shall be wetted at one percent (1%) to three percent (3%) above optimum moisture.

In cuts when the undisturbed earth is suitable for the subgrade, manipulation other than rolling will not be required, provided the upper three (3) inches is at 95% maximum dry density as called for in embankments.

12.04 Water Main, Storm and Sanitary Sewer Pipe Bedding and Backfill. The pipe bedding and backfill shall be Type "C" as required by Division V, Pipe Bedding, Trench Backfill, and Nonshrinkable Backfill. The completion of the trench backfill under pavement shall be adequate to provide 95% of maximum dry density and shall be wetted to within 3% optimum moisture as specified in this division under Subgrade Preparation.

12.05 Granular Foundation Course. This work shall consist of the construction of a compacted foundation course of granular material to the lines, grade, and dimensions shown on the plans on a previously prepared and approved subgrade.

12.06 Surplus Earth. All surplus earth shall be stockpiled by the Contractor at the location or locations designated on the plans or as the Engineer shall direct.

12.07 Adjustment of Manholes. All manholes encountered whether shown on the plans or not shall be brought to the proper grade by removing the castings and adjusting the tops of the existing manholes by removal or addition of concrete or brick, as the case may be, and resetting the frames and covers.

Brick masonry shall consist of the type of brick satisfactory to the Engineer, laid in 1:2 cement mortar. All brick must be wetted before being laid. All joints shall be completely filled with mortar and shall not be less than 1/4 inch and not more than 1/2 inch in thickness.

Contractors are instructed to use plastic or concrete risers to bring manhole ring and covers to grade. Using pieces of wood, concrete or bricks and then filling with concrete mortar will no longer be accepted.

All manholes will be inspected before and after a concrete or asphalt street is laid down to insure that no foreign material is in the flow line or at the bottom of a manhole.

Revised 1-18-2010

12.08 Adjustment of Storm Sewer Inlets. All storm sewer inlets shall be adjusted to line and grade by removing the castings and adjusting the tops of the existing storm sewer inlets by removing or adding concrete or bricks, as the case may be, and resetting the castings.

Brick masonry shall consist of the type of brick satisfactory to the Engineer, laid in 1:2 cement mortar. All brick must be wetted before being laid. All joints shall be completely filled with mortar and shall not be less than 1/4 inch and not more than 1/2 inch in thickness.

12.09 Integral Curb. Integral curb shall be constructed on the edge of the concrete slab in accordance with the plans and typical cross section. This curb shall be placed immediately after the concrete on the pavement has been placed and finished and before it takes its initial set. That part of the pavement which is to be covered by the integral curb shall be cleaned of all laitance and shall be roughened. Integral Curb will be required on all new pavement construction. If construction is a very short section, the Director of Public Works may allow an exception upon written request.

SECTION 13 - CONCRETE CONSTRUCTION

13.01 Forms and Form Setting. On all new mainline pavement construction, slip form process will be required. If the Contractor wants to use standard forms rather than slip forms because the area is small, they must submit a written request to the Director of Public Works for an exception. If the request is granted, the contractor will be required to meet certain requirements as listed herein. Outside forms shall be metal, of depth equal to the design thickness of the pavement at its edge, and straight and free from warp. When integral curb is required, the additional height represented by the curb may be obtained by bolting extra forms upon the top of the main form. Wood forms or flexible or curved metal forms of proper radii shall be used for curves having radii of less than 100 feet. The forms shall be neatly, tightly, and securely pinned and staked to the line and grade furnished by the Engineer. They shall not at any time show a variation of more than 1/8 inch in a ten (10) foot length from the true plane of top of forms. Shimming with loose earth, pebbles, etc. will not be permitted.

Forms shall be cleaned and oiled before concrete is placed against them.

When pavement is being laid contiguous to previously finished concrete pavement of the same finish grade elevation or contiguous to previously finished independent curb and gutter, such finished pavement or curb and gutter may be made to serve as side forms and as a guide for striking, tamping, and finishing equipment.

13.02 Air Entraining. When using specifications for State of Nebraska 47-B concrete, the total air content shall be 6% plus or minus 1-1/2% by volume of the wet concrete as determined by AASHTO Standard Method T-121 or ASTM Method C-231 and up to 9% for sand and gravel mix.

13.03 Consistency. The quantity of water shall be determined by the Engineer in accordance with these specifications under section entitled Cement - 47-B (Modified) and ABX (Modified) Concrete and not varied without the Engineer's consent. The Contractor shall furnish and use with the mixer an approved adjustable water measuring device which will prevent excess water flowing into the mixer so the consistency may be under positive control and all batches may be of the same consistency.

In general, the minimum amount of water shall be used which will produce the required workability. The mortar shall cling to the coarse aggregate and shall show no free water when removed from the mixer. The upper surface of the set concrete shall show a cement film upon the surface and shall be free from all laitance. In no case shall an amount of water be used sufficient to cause the collection of a surplus on the surface or to cause segregation during the transportation to place of deposit. The concrete must be of workable consistency when placed.

13.04 Mixing. The mixing shall be done in a batch-mixer of approved type which will insure the uniform distribution of the material throughout the mass so the mixture is uniform in color and smooth in appearance. No mixer which has a capacity of less than one-sack batch shall be used on any work. The concrete shall be mixed in quantities required for immediate use. Concrete which has developed initial set or is not in place within thirty (30) minutes after the water has been added shall not be used. Retempering concrete by adding water or by other means will not be permitted.

The concrete shall be mixed for a period of at least one (1) minute after all the ingredients are assembled in the drum with the drum revolving at a rate for which the mixer was designed but, in no case, shall it be less than twelve (12) nor more than twenty (20) revolutions per minute. The mixer shall be equipped with an attachment for satisfactorily locking the discharging device to prevent the emptying before the minimum time required. The entire contents of the drum shall be discharged before any materials for the succeeding batch are placed therein.

No concrete shall be mixed while the air temperature is at or below 40 degrees Fahrenheit, except when specifically permitted by the Engineer. In such case, all water used for mixing concrete shall be heated to a temperature of at least 70 degrees but not over 150 degrees Fahrenheit. When artificial heat is applied and the air temperature is above 32 degrees Fahrenheit, the mixed concrete shall not be less than 70 degrees Fahrenheit at the time of the placing in the forms, and no concrete shall be placed in the forms when the air temperature is below 32 degrees Fahrenheit. In no case shall material containing frost or lumps of hardened material be used. When ready-mixed concrete is to be produced, the Contractor shall notify the Engineer in writing at least fourteen (14) days in advance of mixing operations as to location, type of plant and equipment which they propose to use in proportioning, mixing, and hauling concrete.

The Contractor shall furnish at least eight (8) standard 50 pound weights for calibrating and testing scales used in weighing aggregates and cement.

Ready-mixed concrete shall be mixed and delivered to the site of work by means of one of the following combinations of operations:

1. Mixed completely at a central mixing plant and the mixed concrete transported to the point of delivery in a truck agitator or in a truck mixer operating at agitator speed or in approved non-agitating equipment (known as central-mixed concrete).
2. Mixed partially at a central mixing plant and mixing completed in a truck mixer (known as transit-mixed concrete).
3. Aggregates and cement proportioned in a central plant and mixed completely in a truck mixer (known as transit-mixed concrete).

All mixers and agitators shall be operated within the limits of the manufacturer's rated capacity. They shall be operated at the speed of rotation for which the equipment was designed. Attached to each truck mixer and truck agitator shall be a metal plate on which is stated the manufacturer's capacities in terms of volume of mixed concrete and the manufacturer's stated speed of rotation for both mixing and agitation.

The truck mixer or agitator shall consist of a closed water-tight revolving drum suitably mounted and fitted with adequate revolving blades. Truck mixers shall be capable of combining aggregates, cement, and water into a thoroughly mixed and uniform mass of concrete and of discharging the concrete without segregation. Truck agitators shall be capable of transporting and discharging concrete without segregation.

For revolving drum type mixers the mixing speed shall not be less than seven (7) revolutions per minute of the drum nor greater than that which will produce a peripheral velocity of more than 225 feet per minute. For revolving blade type mixers, the mixer speed shall not be less than six (6) nor more than sixteen (16) revolutions per minute of the mixing blades. Agitation speed shall not be less than two (2) nor more than six (6) revolutions per minute of the drum or mixing blades.

Concrete transported without agitation shall not be used if the period elapsed between the time the concrete is discharged from the mixer and the time it is placed is greater than thirty (30) minutes. Concrete transported with agitation shall not be used when the cement has been in contact with the aggregate more than 1-1/2 hours before it is placed.

13.05 Placing and Finishing. The concrete shall be deposited on the prepared subgrade or on the granular foundation course so there shall be no separation of the mortar and the aggregate, and then shall be spread to the required depth and for the entire width of the pavement by approved methods, struck off, and finished. The subgrade templet shall be drawn over the subgrade or foundation course ahead of the point where concrete is being placed and shall be kept in position while the concrete is being placed. The concrete shall be deposited on the subgrade or granular foundation course between the forms in position and in such quantity as to make a uniform layer of about one (1) inch greater than the required thickness. During the operation of striking off the concrete, a uniform ridge of concrete at least three (3) inches in depth shall be maintained ahead of the vibratory strike-off screed for its entire length. After being deposited, it shall be consolidated along the forms and along all joints. At the end of the day or in case of unavoidable interruption of more than thirty (30) minutes, a transverse construction joint shall be placed at the point of stopping work, provided the section on which the work has been suspended shall not be less than ten (10) feet in length. The working edge of the screed shall be shaped to the required cross section of the pavement. After the concrete has been properly consolidated and struck off, the entire surface shall be floated longitudinally, from bridges, with a float at least twelve (12) feet long and twelve (12) inches wide. If made of wood, this float shall be two (2) inches thick. If made of metal, it shall have a weight approximately equal to a similar float made of two (2) inch plank and shall be lined on its bottom face with wood, having rounded edges. The float shall be operated by two men, one at each end, each man standing on a bridge spanning the pavement. The longitudinal and transverse motion shall be passed slowly from one side of the pavement to the other a sufficient number of times, at least twice, until the float on its last passage shall show contact with the concrete throughout its entire length. The bottom surface of the float shall remain flat on the surface of the concrete during the entire operation of longitudinal floating. The next section to be floated shall overlap the one previously floated by half the length of the float.

After the concrete has been floated longitudinally, the surface shall be floated transversely using a float of 1"x12" material three (3) to four (4) feet in length and fitted with a handle of sufficient length to permit the float to reach just beyond the center line. Any high or low areas exposed as a result of this floating shall be corrected prior to belt finishing.

After the concrete has been floated transversely and the water sheen has disappeared from the surface of the pavement, the final finish shall be given with a canvas or rubber belt, burlap drag or brooming, or any combination of the above as directed by the Engineer.

If belting is selected, it shall be accomplished with a belt of two to four ply having a width of not less than six (6) inches and a length at least two (2) feet greater than the width of the pavement. The belt shall be operated with a combined crosswise and longitudinal motion, care being taken not to work the crown out of the pavement or to permit the edges of the belt to dip into the surface of the concrete.

If a broom finish is selected, it shall be accomplished by drawing a broom across the surface from the center line toward each side with the broom held perpendicular to the surface with only one stroke of the broom on each portion of the surface. (If the pavement is being constructed lane-at-a-time, the broom shall be drawn across the full width of each lane in one operation.) The broom shall be of the push broom type not less than 18" wide made from bass or bassine fiber not more than five (5) inches long and with a handle at least one (1) foot longer than the width of pavement being broomed in one operation. The brooming operations shall be executed so the corrugation will be uniform in appearance and not more than 1/16 inch in depth.

If a burlap drag finish is selected, it shall be accomplished by drawing a wet burlap, carpet, or canvas drag over the surface in a longitudinal direction. The drag shall be at least two (2) feet longer than the width of the slab being placed and shall be wide enough so about three (3) feet will be in contact with the pavement while it is in use. If burlap is used, the drag shall consist of not less than two (2) layers. Drags shall be rinsed or washed as often as necessary to remove hardened particles which would mar the uniform surface that would be obtained with a clean drag.

13.06 Surface Test. Before final finishing and previous to initial set, the surface of the pavement shall be tested under the supervision of the Engineer. All irregularities or undulations not within the tolerance of the following test shall be corrected with fresh concrete and the affected surface brought within the requirement of the test and refinished if necessary. The test shall be made with a transverse testing templet and straightedge at least ten (10) feet long. The templet shall be accurately shaped in conformity with the typical cross section and shall be subject to the approval of the Engineer. The templet shall be used to test the shape of the surface transversely, the straightedge for longitudinal trueness. The straightedge shall be placed parallel to the center line so as to bridge any depressions and touch any high spots. Ordinates exceeding one fourth inch measured from the face of the templet or straightedge when in position at any point shall be eliminated by means of a long-handled wood float.

As soon as the pavement has set sufficiently to permit walking on it and not later than 10:00 a.m. of the day following the placing of the concrete, it shall be thoroughly checked by the inspector with a straightedge. All variations in excess of one fourth inch measured from the surface of the straightedge when it is placed parallel to the center line shall be plainly marked. The Contractor shall at once eliminate such variations by the use of approved grinding tools or carborundum brick and water. The work of grinding or rubbing shall not be performed in such manner or carried to such extremes that the bond of the concrete shall be broken. The use of brush hammer or similar device to remove irregularities after the concrete has taken its final set will not be permitted. All templets, straightedges, and other testing devices shall be furnished by the Contractor.

13.07 Headers. Concrete headers extending to full depth and width of the pavement shall be constructed at locations shown on the plans. They shall be constructed to the dimensions and design called for in the plans.

13.08 Transverse Construction Joints. Whenever concreting is stopped for a period of over thirty (30) minutes, a transverse construction joint shall be formed by finishing the concrete to a bulkhead made of two (2) inch material cut to the exact cross section of the pavement slab, as shown in the plans. When the concreting is resumed, the bulkhead shall be moved taking care not to disturb any concrete placed. The joints shall be constructed perpendicular to both the center line and the surface of the pavement. In no case shall an emergency construction joint be allowed within ten (10) feet after placing a regular expansion or construction joint. If the joint falls within this limit, the concrete shall be removed back to the previously installed joint.

When a construction joint is placed at a location where integral curb is being constructed, a piece of pre-formed joint material one half inch in thickness and conforming to the cross section of the curb shall be placed through the curb at the construction joint. The edges of the concrete shall be rounded to a radius of not more than one fourth inch.

13.9 Transverse Expansion Joints. Expansion joints shall be of a premoulded bituminous fiber type conforming to these specifications under the section entitled Joint Filler.

The joint shall extend entirely through the pavement and the joint filler shall be placed so the top edge will be one half inch below the surface of the finished pavement. No section of the joint material shall be shorter than the width of pavement strip between longitudinal joints. Before the pavement is opened to traffic, this space shall be swept, cleaned, and filled with approved joint sealing material.

The pre-formed expansion joint material shall be held securely by means of a special metal joint holder and removable cap, perpendicular to both the center line and the surface of the pavement. The metal joint holder and cap shall remain in place until after the passage of the concrete spreader. After the concrete has been finished, the metal joint holder and cap shall be removed and the edge of the concrete rounded to a radius of not more than one fourth inch. When integral curb is being constructed, an additional piece of pre-formed material of the same cross section as the curb shall be extended through the curb and to the top surface of the pavement. The joints shall be so installed and finished to insure complete separation of the slabs.

13.10 Transverse Contraction Joints. Transverse contraction joints shall be constructed at intervals of not less than ten (10) feet or more than sixteen (16) feet. The joints shall be true and straight to the center line and surface of the pavement. Variation of more than one half inch in ten (10) feet from a straight line will not be permitted. The joint shall be placed so its junction with the longitudinal joint will be a neat fitting connection. All transverse contraction joints shall be done by the saw cut method. To prevent the development of random cracks, joints at approximately eighty (80) feet intervals shall be sawed the same day as the pour is made. All other transverse contraction joints shall be sawed the following afternoon.

13.11 Longitudinal Joints. Longitudinal contraction joints, when required, shall be in accordance with the requirements for transverse contraction joints.

All sawed longitudinal joints shall be sawed before the concrete has attained an age of seven (7) days and before the pavement is opened to any vehicular traffic.

13.12 Curing. As soon as the concrete has hardened sufficiently to prevent excessive marring of the surface or adherence thereto, the concrete shall be protected with a single covering of burlap, placed and kept saturated for at least twelve (12) hours. As soon as the burlap is removed, the top surface and the edges of the pavement shall be covered with a continuous uniform nonbituminous impervious coating. The curing compound may be applied in either one or two applications in accordance with the directions of the manufacturer. However, if applied in two coatings, the second shall be applied not later than thirty (30) minutes after the first. In no case shall the rate of application be less than one (1) gallon per fifteen (15) square yards of surface area.

The sides of the pavement slab or back side of integral curb shall be covered with the curing compound within thirty (30) minutes after removal of the form.

When wet cotton mats, wet jute felt mats, paper, or any other method than curing compound is to be used for curing, the Contractor shall notify the Engineer in writing at least fourteen (14) days in advance giving the type and specifications of material and method to be used.

When it is expected that during the progress of the work the temperature may fall below 40 degrees Fahrenheit, a sufficient supply of straw, hay, grass, or other material suitable, in the judgment of the Engineer, must be maintained on hand to cover the concrete and to sufficiently protect the surface and edges against freezing until it is at least ten (10) days old. In such case, at the discretion of the Engineer, wetting and spraying may be omitted. Manure shall not be used as a protection for green concrete. Whenever the temperature falls below 40 degrees Fahrenheit, freshly finished concrete shall be protected by frames enclosed by canvas or other type of housing and the temperature of the air surrounding the concrete shall be maintained at not less than 45 degrees Fahrenheit. Sufficient heating apparatus, such as lanterns, suitable stoves, or steam equipment, shall be furnished and maintained by the Contractor. Any concrete showing injury by freezing on uncovering shall be removed and replaced at the expense of the Contractor.

13.13 Sealing of Joints. Joint sealing operations shall not be started until after final curing is completed. All joints which require sealing shall be thoroughly cleaned by a jet of compressed air. Any excess mortar or concrete shall be cut out with chisels. Joints shall be filled only when completely dry. The filler used shall be material as specified in these specifications under the section entitled Joint Sealing Material. The cleaning and filling shall be carefully done with proper equipment and a neat workmanlike joint obtained, free from excess and unsightly filler.

The joint sealing material shall be melted uniformly and with constant stirring in an asphalt kettle of such design that direct flames are not applied to the immediate surfaces of the kettle which are in contact with the joint sealing material. The material shall be furnished or prepared in pieces of such size and shape that the material can be melted readily to the proper pouring consistency. The heating of the material shall be arranged to minimize the length of time during which the temperature of the material exceeds 350 degrees Fahrenheit. In no case shall the temperature exceed the maximum recommended by the manufacturer. The joints shall be filled with the use of a pouring device which is satisfactory to the Engineer. Precautions shall be taken to prevent spilling material on surfaces of the pavement adjacent to the joint.

13.14 Protection. The Contractor shall provide and maintain substantial barricades, warning signs, and flares to provide the public and the construction work adequate protection and keep all traffic off the pavement.

13.15 Opening to Traffic. Before any traffic is permitted on the concrete, all curing and protecting materials other than membrane shall be carefully removed from the finished work and the concrete shall be swept clean. No section of pavement shall be opened to traffic until the concrete has reached a minimum age of fourteen (14) days or compression strength of 3000 psi.

The Contractor's forces may be allowed on the pavement for the purpose of clean up work any time after the concrete has reached a minimum age of seven (7) days.

13.16 Acceptance. The Contractor shall furnish a minimum of two (2) cores at locations designated by the Engineer for each 1000 square yards of pavement placed, and the acceptance of the pavement may be governed by the quality and thickness as shown by the cores. Slabs of pavement which are found to be more than one half inch short of the specified thickness shall be removed and replaced at the Contractor's expense with concrete of specified quality and thickness. If, however, in the opinion of the Engineer, there is no probability of immediate failure of such deficient slabs, they may allow the Contractor the choice of leaving the defective slabs in place and receiving no compensation or payment for the same or of replacing the pavement slab as provided above.

If the average strength of test cores or test cylinders, cured at a temperature within the range of 60 to 80 degrees Fahrenheit, is more than ten percent (10%) below the required strength, the Engineer may elect either to permit such pavement to remain in place and limit the payment for such defective work to a maximum of 90% of the contract unit price or require the Contractor, at Contractor's expense, to remove the pavement area deficient in the specified strength and replace it with pavement of satisfactory quality.

SECTION 14 - METHOD OF MEASUREMENT AND BASIS OF PAYMENT

14.01 Clearing and Grubbing. Clearing and grubbing of trees larger than six (6) inches in diameter will be measured for payment by counting the actual number of trees removed. The diameters of trees will be computed by measuring the circumference and dividing by 3.14. Payment shall be made at the contract unit price per each tree at the diameter or group of diameters shown in the bid.

Stumps will be measured for payment by taking the average diameter at cutoff. Payment shall be made at the contract unit price per each stump at the diameter or group of diameters shown in the bid.

Hedge removal will be measured for payment in lineal feet of a row of hedges.

Weeds, rubbish, and other herbaceous vegetation will not be measured for payment but will be considered as subsidiary to the contract work.

14.02 Site Preparation. Crosswalks and private walks to be removed within the area between construction lines will be measured for payment in square feet in their original position. Driveway approaches will be measured for payment in square yards in their original position.

Existing straight curb and curb and gutter to be removed will be measured for payment by length in lineal feet. Measurements for the straight curb will be made along the front face of the curb. Measurements for curb and gutter will be made along the flow line of the gutter.

Removal of existing pavement headers will be measured for payment by length in lineal feet.

Compaction over all existing utility lines will be measured for payment as a single unit except when in clay soil. In clay soil, excavation, additional materials, and recompaction over utility lines will be paid for as additional excavation.

14.03 Grading, Surplus Earth, Embankment. All grading, removal of surplus earth, and embankment will not be measured for payment but shall be subsidiary to the paving.

14.04 Granular Foundation Course. Granular foundation course will be measured for payment by area in square yards or cubic yards.

14.05 Manholes. Adjusting manholes to grade will be measured for payment as a single unit for each manhole that is adjusted to grade as shown in the plans or as directed by the Engineer.

14.06 Storm Sewer Inlets. Adjusting storm sewer inlets to line and grade will be measured for payment as a single unit.

14.07 Integral Curb. Integral curb will be measured for payment by length in lineal feet. Measurement will be made along the back side of the curb.

14.08 Concrete Pavement. Concrete pavement will be measured for payment by area in square yards. Concrete pavement shall include all joints, curing, sealing, etc. not specifically designated as separate items.

14.09 Beams. Concrete pavement beams will be measured for payment by length in lineal feet.

14.10 Headers. Concrete headers constructed as part of the project will be measured for payment by length in lineal feet.

14.11 Transverse Expansion and Miscellaneous Joints. Transverse expansion joints and all miscellaneous joints using premoulded bituminous fiber will be considered incidental to the paving construction and not as a separate pay item.

14.12 Concrete Test Cylinders. Three (3) concrete test cylinders shall be required for each block of concrete pavement placed or as directed by the Engineer.

14.13 Testing. The Engineer may require testing of coarse and fine aggregates and cement before they are used in the work. If so ordered, the Contractor shall pay the cost thereof.

The testing of cylinders shall be paid for by the Contractor.

14.14 Miscellaneous. Any item listed in the Engineer's Estimate and not covered in the specifications will be measured in the most workmanlike manner for payment according to the designation listed such as cubic yards, square feet, square yards, lineal feet, gallons, each, etc.

DIVISION III

CURB AND GUTTER SIDEWALKS, AND DRIVEWAYS

**DIVISION III
CURB AND GUTTER,
SIDEWALKS AND DRIVEWAYS**

C O N T E N T S

| Section | Description |
|-----------|---|
| 15 | SCOPE OF WORK |
| 16 | MATERIALS |
| 16.01 | Cement |
| 16.02 | Sand-Gravel |
| 16.03 | Fine Sand and Coarse Aggregate |
| 16.04 | Water |
| 16.05 | Joint Filter |
| 16.06 | Joint Sealing Material |
| 17 | CONSTRUCTION METHODS |
| 17.01 | Subgrade Preparation |
| 17.02 | Forms and Form Setting |
| 17.03 | Concrete |
| 17.04 | Expansion Joints |
| 17.05 | Clean Up |
| 18 | CURB AND GUTTER |
| 19 | SIDEWALKS |
| 20 | DRIVEWAYS |
| 21 | METHOD OF MEASUREMENT AND BASIS OF PAYMENT |
| 21.01 | Curb and Gutter |
| 21.02 | Sidewalks |
| 21.03 | Driveways |
| 21.04 | Expansion and Miscellaneous Joints |
| 21.05 | Acceptance |

**DIVISION III
CURB AND GUTTER,
SIDEWALKS AND DRIVEWAYS**

This division is written so that ordinarily the type of construction described is complete, but, where applicable, other divisions are considered a part of these specifications.

SECTION 15 - SCOPE OF WORK

This work shall consist of constructing curb and gutter, sidewalks, and driveways of Portland cement concrete on an approved, prepared subgrade in strict accordance with these specifications and in conformity with the lines, grades, and applicable drawings. All curb and gutter districts constructed shall conform to Division II, Portland Cement Concrete, as well as these specifications.

SECTION 16 - MATERIALS

16.01 Cement - Portland cement shall conform to all requirements of ASTM C-150, Type I, "Specifications for Portland Cement", with subsequent additions and amendments thereto, and also the following general requirements.

Cement shall be stored to provide adequate protection against dampness, and no cement shall be used that has become caked or lumpy. No reclaimed cement shall be used. No cement which has been left in storage more than ninety (90) days after shipment from the mill shall be used unless retested and, if failing to meet the requirements specified, shall be rejected. Normally, cement purchased from local dealers shall be considered satisfactory.

16.02 Sand-Gravel - Sand-gravel for concrete shall be a mixture of sand and gravel composed of clean, hard, durable, uncoated pebbles free from injurious amounts of soft or flaky particles, shale, alkali, organic matter, or other deleterious materials. The following materials shall be considered objectionable and percentage by weight shall not be greater than:

| | |
|--|-----|
| Clay lumps | 0.5 |
| Coal and carbonaceous shale | 0.5 |
| Unsound chert particles retained on 3/8" sieve | 3.0 |

Gradation requirements for sand-gravel aggregates for concrete are as follows:

| | <u>Minimum</u> | <u>Maximum</u> |
|--------------------------------|----------------|----------------|
| Total % retained on 1" sieve | -- | 0 |
| Total % retained on #4 sieve | 10 | 35 |
| Total % retained on #10 sieve | 45 | 65 |
| Total % retained on #20 sieve | 65 | 85 |
| Total % retained on #30 sieve | 75 | 85 |
| Total % retained on #100 sieve | 95 | 100 |
| Total % retained on #200 sieve | 97 | 100 |

Platte River sand-gravel meeting the above gradation is considered satisfactory.

16.03 Fine Sand and Coarse Aggregate. When 47-B concrete is required, see Division II, Portland Cement Concrete Pavement, for specifications.

16.04 Water. Water used for mixing concrete shall be free from oil, acid, alkali, organic matter, or other deleterious materials. Water from wells or City mains shall be considered satisfactory.

16.05 Joint Filter. Joint filter shall consist of premolded bituminous fiber uniformly impregnated with between 35% and 50% durable asphalt by weight and being furnished in strips of the dimensions specified in the plans. A one (1) inch thick sample when compressed to 50% of original thickness at a rate of 1/10 inch per minute and released shall show at least 70T recovery within one hour after compression and shall not have required more than 500 pounds per square inch compression load and extrusion of not more than 1/8 inch.

Expansion joint material shall be 3/4 inch or more in thickness and shall conform to AASHTO M33-48 (Pre-formed Expansion Joint Filler for Concrete).

16.06 Joint Sealing Material. The hot pour paving joint materials shall be of the rubber-asphalt type and shall be melted in a double jacket kettle equipped with an agitator for stirring the material during melting and pouring. The rubber-asphalt shall meet Federal Specifications SS-S-164 or subsequent revisions.

SECTION 17 - CONSTRUCTION METHODS

17.01 Subgrade Preparation. The subgrade shall be prepared by excavating or filling to the required elevation for bottom of concrete. The subgrade shall be thoroughly tamped or otherwise compacted to insure stability. In fills, the subgrade shall be made at least one foot wider on each side than required by the curb and gutter, sidewalk, or driveway.

Stakes will be set by the City Engineering Division of the Public Works Department for line and grade after a sidewalk permit has been issued by the Public Works Department. The subgrade shall slope toward the street curb on a grade of not less than one-fourth inch per foot.

Where fill is required, it will be laid in six (6) inch layers and thoroughly tamped to the satisfaction of the Engineer. Mushy or spongy material will not be used for fill material. Soft and spongy material will be removed and replaced with suitable backfill material.

Trees that are in the way of the sidewalk will be removed including the stump. Roots of trees that are located outside the sidewalk but extend under the sidewalk shall be cut off at least six (6) inches below the sidewalk.

17.02 Forms and Form Setting. The forms shall be of wood or metal, straight and free from warp, and of sufficient strength to resist springing during the process of depositing concrete against them. All forms shall be securely staked, braced, and held firmly to the required line and grade. All forms shall be thoroughly cleaned and oiled before concrete is placed against them.

Wood forms shall be not less than 1-5/8 inches in thickness except for curvilinear sections where properly braced forms of lesser thickness may be used.

Tolerances of 1/8 to 1/4 inch shall be maintained for form alignment and vertical elevation.

17.03 Concrete. Concrete shall conform to Division II, Portland Cement Concrete Pavement.

Concrete shall be mixed in an approved mixer with sufficient water added to produce a workable mix. In no case shall so much water be used as to cause the collection of a surplus on the surface or to cause segregation during transportation to place of deposit. All materials shall be accurately weighed or measured, and mixing shall continue for a full minute after all materials are in the drum of the mixer. Any concrete which is not in place within thirty (30) minutes after the water has been added shall not be used.

The operation of depositing and compacting concrete shall be conducted so as to form a compact, dense, artificial stone of uniform texture which shall show smooth faces on all exposed surfaces.

Transit-mixed or ready-mixed concrete may be used provided the concrete is placed in the forms before it has developed initial set and shall comply with ASTM C95-58 and the requirements of these specifications. Such concrete must be transported in such a way as to prevent segregation between the aggregates and the cement. Concrete shall develop an ultimate compressive strength of not less than figures shown in Section 11.01 when tested in standard 6" x 12" cylinders at an age of twenty-eight (28) days in accordance with ASTM C39-56T.

Hand mixing of concrete will not be permitted except with specific permission of the City Engineer on very small jobs or in case of emergency.

The concrete surface shall be treated with a liquid treatment for curing such as Tri-Kote or approved equal or burlap cure or plastic covering may be used in the concrete cure. The plastic film used for curing concrete or subgrade insulating material shall be tough, pliable, moisture-proof, and sufficiently durable to retain its moisture-proof properties. The plastic film can be a polyethylene film not less than 0.001 inch thick. Reinforcement materials where required or as shown on the plans and wire mesh shall comply with ASTM A-185 and reinforcing bars where required shall conform to ASTM A-15 or A305.

Air entrained concrete shall be obtained by using air-entrained Portland cement or air-entraining admixtures. Air content of fresh concrete shall measure six (6) to nine (9) percent. Air entrained concrete shall be used for all sidewalks, driveways, and curb and gutter.

The use of high-early strength Portland cement concrete will not be required unless stipulated in the plans and in the Special Provisions on certain contracts.

Concrete shall not be placed when inclement weather prevents good workmanship. Concrete shall not be placed when temperature is below 40 degrees F without specific permission of the Engineer.

The surface shall be wood floated to give a proper roughness to prevent foot slippage for normal foot traffic.

The cross slope shall be 1/4 inch per foot of width of sidewalk.

The sidewalk after pouring shall be protected from foot traffic for twenty-four (24) hours and vehicle traffic for seven (7) days.

17.04 Expansion Joints. Expansion joints shall be placed as indicated on the drawings or at each location where new construction connects with existing construction. Specifically, joints shall be placed where new curb and gutter joins existing curb and gutter, where sidewalks connect to curb and gutter, and at such other locations as the Engineer may direct. On long runs of new construction, joints shall be placed as directed. In no case shall the spacing between expansion joints exceed one hundred (100) feet.

SECTION 18 - CURB AND GUTTER

Concrete curb and gutter shall be constructed to the lines, grades, dimensions and design as called for in the drawings.

There shall be installed every six (6) feet a separator true to the dimensions and cross-section of the combined curb and gutter. This separator shall be removed after the concrete has taken its initial set and the joint properly edged to provide a neat joint. In finishing joints prior to and after removal of separators, extreme care shall be exercised to avoid raising the edge of the joint causing water pockets in the gutter flow line. Separators shall not exceed 1/8 inch in thickness. Immediately following finished operations and before the concrete has taken its final set, the gutter flow line shall be checked with a straightedge not less than ten (10) feet in length and approved by the Engineer.

The maximum deviation from true grade shall not exceed 1/4 inch and any irregularities shall be corrected immediately.

SECTION 19 - SIDEWALKS

Concrete sidewalks shall be constructed to the lines and grades determined by the Engineer. Sidewalks shall have a minimum width of four (4) feet and a depth of four (4) inches and shall be constructed with a side slope of 1/4 inch per foot unless otherwise approved by the Engineer or Engineer's representative. Surfaces shall be marked off in square blocks having an area of not less than sixteen (16) nor more than thirty-six (36) feet. On these lines, the concrete shall be cut through not less than 1/4 inch thickness with a pointed trowel or suitable spading tool and the concrete edged on both sides.

Sidewalks that are being constructed across driveway openings shall have a minimum depth of five (5) inches.

The surface shall be floated with a steel float just enough to produce a smooth surface, free from irregularities. All edges and joints shall be rounded to a radius of 1/4 inch with an approved finishing tool. The surface shall then be brushed with a fine bristle broom or wood float to slightly roughen the surface and remove the finishing tool marks.

SECTION 20 - DRIVEWAYS

Driveway approaches connecting private driveways to City streets shall be constructed with Portland cement concrete except where the private driveway connects to a full depth asphalt street. Where the driveway connects to a full depth asphalt street, asphaltic concrete may be used in construction of the driveway approach.

Driveway approaches shall be constructed to the lines and grade set by the Engineer. The minimum depth of both Portland cement concrete and asphaltic concrete for driveway approaches shall be five (5) inches and, in the event heavy loads are anticipated, the depth shall be increased to handle the expected loads.

SECTION 21 - METHOD OF MEASUREMENT AND BASIS OF PAYMENT

21.01 Curb and Gutter. Combination curb and gutter will be measured for payment by length in linear feet. Measurements will be made along the flow line of the gutter.

21.02 Sidewalks. Sidewalks will be measured for payment by area in square feet.

21.03 Driveways. Driveways as referred to in this paragraph are that portion of existing driveway approaches having to be removed behind the construction lines of pavement due to the driveway approach lying partly within the area between construction lines. Driveways will be measured for payment in area in square yards.

21.04 Expansion and Miscellaneous Joints. Expansion joints and all miscellaneous joints using pre-molded bituminous fiber will be considered incidental to the construction and not as a separate pay item.

21.05 Acceptance. Upon completion of a job, the Engineer shall be notified, and they shall make an inspection of the work. The Contractor will be notified in writing as to the acceptability of the work.

DIVISION IV

ASPHALT CONCRETE SURFACE COURSE

**DIVISION IV
ASPHALT CONCRETE SURFACE COURSE**

C O N T E N T S

| <u>Section</u> | <u>Description</u> |
|----------------|---|
| 22 | SCOPE OF WORK |
| 23 | SPECIFICATIONS |
| 23.01 | State Specifications |
| 23.02 | Smoothness |
| 24 | CONSTRUCTION METHODS |
| 24.01 | Compaction Requirements |
| 24.02 | Asphaltic Cement |
| 24.03 | Prime Coat |
| 24.04 | Tack Coat |
| 24.05 | Armor Coat |
| 24.06 | Bituminous Base Course and Surface Course for Asphaltic Concrete Pavements |
| 24.07 | Seal Coat |
| 24.08 | Heater-Planing |
| 24.09 | Surface and Base Reconditioning |
| 24.10 | Emulsified Asphalt Slurry Coat |
| 24.11 | Asphalt Carpet Coat |
| 24.12 | Asphaltic Concrete Surface Course and Base Course |
| 24.13 | Pavement Removal |
| 24.14 | Miscellaneous Removals |
| 24.15 | Special Provisions |

DIVISION IV
ASPHALT CONCRETE SURFACE COURSE

This division is written so that ordinarily the type of construction described is complete, but, where applicable, other divisions are considered a part of this specification.

SECTION 22 - SCOPE OF WORK

The work covered by this division of the specifications consists of furnishing all labor, plant, equipment, appliances, and materials and performing all operations necessary to construct and complete the prime coat and asphaltic concrete pavement and appurtenances in strict accordance with the specifications and applicable drawings and subject to the terms and conditions of the contract.

SECTION 23 - SPECIFICATIONS

23.01 State Specifications. The most current State of Nebraska Standard Specifications for Highway Construction along with any drawings or additional addenda shall apply to any and all asphaltic concrete materials and construction methods.

23.02 Smoothness. Except as specified in NDOR 502, acceptance requirements for smoothness shall be as specified in Section 3.17 "ACCEPTANCE REQUIREMENTS" of the Asphalt Institute's latest edition of "MODEL CONSTRUCTION SPECIFICATIONS FOR ASPHALT CONCRETE AND OTHER PLANT-MIX TYPES."

SECTION 24 - CONSTRUCTION METHODS

24.01 Compaction Requirements. The top six (6) inches of the final subgrade shall be scarified and rolled with a sheep's foot roller, with water added, if necessary, to obtain compaction to a density of not less than 95% of maximum dry density at optimum moisture content as determined by AASHTO Method T-99. A minimum of one successful density test per block will be required before the placement of any asphaltic concrete surfacing.

Final preparation of the subgrade shall include minor compaction and scarifying up to a depth of two (2) inches, furnishing and applying water, removing loose material, and minor shaping and smoothing of the surface.

Direct payment will not be made for earthwork, subgrade preparation, final preparation, and maintenance of the subgrade. This work shall be subsidiary to asphaltic concrete surface course.

24.02 Asphaltic Cement. Asphaltic cement shall be paid for separately by the gallon. Total pay gallons will be based on actual AC content when the actual AC content is within 0.2% points of the AC content specified by the Engineer. If the actual AC content is more than 0.2% points below that specified by the Engineer, an additional 0.1% point will be deducted from the payment for each 0.1% point below the 0.2% point variance allowed. No payment will be made for asphaltic cement beyond 0.2% points above the specification. The Engineer may reject areas where the AC content is more than 0.5% points above or below specifications based on individual extractions. Areas where the AC content is more than 1% point above or below specifications based on individual extractions must be rejected. Following are examples to illustrate:

| AC Content | Specified Extraction | Payment Based On |
|------------|----------------------|------------------|
| 5.0% | 5.2% | 5.2% |
| 5.0% | 4.8% | 4.8% |
| 5.0% | 5.5% | 5.2% |
| 5.0% | 4.5% | 4.2% |
| 5.0% | 5.6% | May be rejected |
| 5.0% | 4.4% | May be rejected |
| 5.0% | 6.1% | Will be rejected |
| 5.0% | 3.9% | Will be rejected |

Where more than one extraction is taken, an average will be computed for payment. In computing the average, AC contents more than 0.2% above the specified content will be changed to the specified content plus 0.2% points. Following is an example based on a specified AC content of 5.0%.

| Actual Extractions | Use for Payment Computations |
|--------------------|--------------------------------|
| 5.1% | 5.1% |
| 4.8% | 4.8% |
| 4.5% | 4.5% |
| 6.0% | 5.2% (if accepted by Engineer) |
| Avg = 5.1% | Avg = 4.9% |

Payment would be made based on the 4.9% average.

24.03 Prime Coat. The prime coat shall conform to the most current State of Nebraska, Standard Specifications for Highway Construction.

24.04 Tack Coat. The tack coat shall conform to the most current State of Nebraska, Department of Roads, Standard Specifications for Highway Construction.

24.05 Armor Coat. The armor coat shall conform to the most current State of Nebraska, Department of Roads, Standard Specifications for Highway Construction.

24.06 Bituminous Base Course and Surface Course for Asphaltic Concrete Pavements. The bituminous base course and/or surface course for asphaltic concrete pavements shall conform to the most current State of Nebraska, Department of Roads, Standard Specifications for Highway Construction.

24.07 Seal Coat. The seal coat shall conform to the most current State of Nebraska, Department of Roads, Specifications for Highway Construction.

24.08 Heater-Planing. The work covered by this section consists of furnishing all plant, labor, and equipment and performing all operations in connection with the heating and planing of existing pavements to true up existing surfaces within the limits and in accordance with the methods, procedures, type, and area as outlined and described in this section and the applicable drawings, and to the depth designated by the Engineer.

The amount of work indicated in the bid form may be increased or decreased by whatever amount is deemed advisable by the Engineer. For any such increase or decrease in work there shall be no consequent change from the unit prices as bid in this contract.

A. Equipment - The planing machine shall be designed and built for the heater planing of heavy traffic type asphaltic concrete pavements and shall be self-propelled. The heating and cutting width of the machine shall be the same and shall not be less than three and one-half (3-1/2) feet. The total weight shall not be less than 17,000 pounds of which seventy percent (70%) plus or minus ten percent (10%) shall be on the rear wheels. The machine shall be capable of traveling at a speed as low as forty (40) feet per minute and be able to cut against all curbs, catch basins, inlets, and other similar obstructions within the paved area. The machine shall have, in combination, a means for heating and cutting the surface and blading the displaced material into one or two windrows in one continuous operation. The overall width or spread of the rear wheels of the machine shall not be greater than the lateral width of the cutting edges and the effective wheelbase of the machine shall not be less than eighteen (18) feet. The make and design of the machine shall be one that has operated successfully on a considerable mileage of work comparable with that proposed to be done under this contract.

B. Public Convenience and Safety - The Contractor shall plan the work so that there will be the least possible interruption to the usual flow of traffic and shall conform to the specific requirements. The Contractor shall be governed by the current regulations of the City. The Contractor shall use all proper precautions to protect persons from injury. Proper guards shall be placed in the vicinity of the work and a sufficient number of colored warning lights placed to protect the public from damage and injury. The Contractor shall be held responsible for all such damage and injuries.

C. Protection of Utilities - Contractors shall use care not to disturb, break, or otherwise damage any visible existing manhole covers, gate valves, etc. in the planing operation. Covers, valves, etc. visible prior to the Contractor's operation shall be replaced by Contractor at Contractor's expense. The adjustment of manholes to the finished grade produced by the heater planer operation is not to be included as work to be done under this item.

D. Construction Methods - Areas to be planed shall be definitely marked out in advance of the work by the Engineer. They shall be rectilinear in shape except where existing facilities do not permit. Payment for completed work shall be made only on the basis of areas as marked out by the Engineer in advance of the work.

Planing operations shall accomplish the cutting of the bituminous surface of the pavement, not to exceed one-half (1/2) inch depth per pass, to a smooth surface without gouging, shoving, or tearing the pavement. The Contractor shall make as many trips with the machine as are necessary to cut to the depth indicated in the plans, specifications, Special Provisions, or as directed by the Engineer and to bring the surface to a tolerance of one-fourth

(1/4) inch when checked with a ten (10) foot straightedge. The Contractor is not to remove more surface than required or directed. Should the bituminous material not permit planing to this tolerance, the condition of the pavement must be called to the attention of the Engineer whose decision will be final.

Immediately after completion of the planing operation, the Contractor shall roll the planed areas with a smooth wheel roller weighing not more than ten (10) tons. Not less than three (3) passes of the roller will be required over the entire area planed.

The Contractor shall remove all pavement cuttings, debris, etc. which resulted from the performance of the work on the street.

E. Coordination with Other Contractors - Some of the projects, which will be properly identified on the plans or in the Special Provisions, are to be overlaid with an asphaltic material after the surface has been heater-planed. The application of the asphaltic material will be accomplished under a separate contract; therefore, close coordination shall be maintained to assure that the surface is heater-planed in advance of the asphaltic material application. The heater-planing contractor shall cooperate with the resurfacing contractor to assure orderly progression of the work to be accomplished.

F. Inspection and Acceptance - Planing operations will be under the direct supervision of the Engineer or Engineer's authorized representative on the work, and the depth and extent to which the planing will be carried out shall be decided by the Engineer as the work progresses. The Engineer shall have authority to reject any work, materials, and parts thereof which do not, in the Engineer's opinion, conform to the plans, specifications, and contract.

G. Measurement and Payment - Heater-planing shall be measured for payment in square yards of pavement actually heated and planed and accepted by the Engineer and shall be paid for at the contract unit price per square yard for the item "Heater-Planing." This price shall be full compensation for furnishing all equipment, plant, tools, labor, flagmen, operators, fuel, hauling, rolling, disposing of planed material, and incidentals necessary to complete the work.

24.09 Surface and Base Reconditioning. This work shall consist of filling cracks, removing and replacing undesirable areas, and patching holes and depressions in existing pavements and bases preparatory to subsequent surfacing or surface treatment.

A. Methods - Except as otherwise provided in this section, all materials used for this work shall conform to the material requirements of these specifications.

B. Crack Filling - On surfaces to be seal coated or armor coated the surface cracks one-fourth (1/4) inch or larger shall be hand raked for a depth of not less than one-half (1/2) inch and then blown clean with compressed air.

Cleaned out cracks shall be filled with MC-800 or Emulsified Asphalt RS-1, and cover coat aggregate poured or broomed into the crack in sufficient quantity to fill the crack.

All cracks one-half (1/2) inch or larger in width in the existing base shall be opened in a wedge shape with air hammers, cleaned with compressed air, painted with Emulsified Asphalt RS-1, and then filled with Asphaltic Concrete Wedge material and thoroughly compacted so as to be even with the adjacent surface.

C. Surface and Base Removal - Surfaces and bases as shown in the plans or as designated by the Engineer shall be removed in accordance with the applicable requirements of the section of these specifications entitled Pavement Removal.

In general, the surfaces requiring removal shall consist of the following types:

1. Asphalt or other surfaces considered unsuitable for use as a base.
2. Asphalt patches containing an excess of bitumen.
3. Loose, excessively cracked or disintegrated asphalt areas.
4. Brick and cobblestone surfaces excessively off grade.
5. Brick, cobblestone, and asphalt surfaces requiring removal to provide for a butt joint.

Except as otherwise shown in the plans or directed by the Engineer, removal of concrete pavements and bases will generally be limited to those areas evidencing disintegration and/or sinking or humping.

Crushed rock bases, when shown in the plans or directed by the Engineer, shall be reworked in accordance with the requirements of the Special Provisions.

D. Surface and Base Repair - Concrete base repair shall be constructed in accordance with the applicable requirements of State of Nebraska specifications which shall be construed to include the following:

1. Repaving areas of concrete bases or pavements previously removed.
2. Resurfacing areas from which brick or cobblestone surface was previously removed, to the level of the existing surface or to such grade as the Engineer may direct.
3. Filling of holes and depressions in the existing base or pavement as the Engineer may direct.
4. Any other work of similar nature or properly inferable from the plans or Special Provisions or directed by the Engineer.

When the contract provides for the placing of asphaltic concrete wedge, base, binder, or surface courses, this material shall be used for patching all holes and depressions in accordance with the requirements of State of Nebraska specifications, except as otherwise provided in this article.

When the contract does not provide for the placing of asphaltic concrete wedge, base, binder, or surface courses, the material used for patching asphalt surfaces shall be one of the following:

1. Asphaltic Surface Course, Type I
2. Material obtained from asphalt plant operated by the City.

This mixture shall be placed in all holes and depressions previously tack coated in accordance with the requirements of the section of these specifications entitled Tack Coat as directed by the Engineer, leveled to the required thickness, and compacted by tamping, ironing, or rolling as may be required to obtain the required density and stability.

E. Measurement and Payment -

1. Crack Filling - Cracks filled under the conditions related in Section 24.09-B shall be measured for payment by length in lineal feet in five (5) chords and shall be paid for at the contract unit price per lineal foot for the item "Crack Filling." This price shall be considered full compensation for all materials, labor, equipment, tools, and incidentals necessary to complete the work required for this item.
2. Removals - Removal of pavements, surfaces, and bases shall be measured and paid for in accordance with the applicable requirements of the section of these specifications entitled Pavement Removal.
3. Reworking Rock Base - Reworking crushed rock base shall be measured and paid for in accordance with the requirements of the Special Provisions.
4. Concrete Base Repair - Concrete used for base repair as related in Item D of this article shall be measured and paid for in accordance with the requirements of the Special Provisions.
5. Asphaltic Concrete Wedge, Binder, or Surface Material - Asphaltic concrete wedge, binder, or surface material used in patching and leveling as provided in Item D of this article shall not be measured separately for payment but shall be included in the quantity for which the contract provides that payment shall be made.
6. Asphalt Patching - Asphaltic mixtures used for patching under the conditions related in Item D of this article shall be measured for payment by weight in tons and shall be paid for at the contract unit price per ton for the item "Asphalt Patching." This price shall be considered full compensation for furnishing and applying all materials including tack coat; for all tamping, ironing, and rolling; and for all labor, tools, equipment, and incidentals necessary to complete the work required for this item.

24.10 Emulsified Asphalt Slurry Coat. The work covered by these specifications consists of furnishing all plant, labor, equipment, and materials and performing all operations in connection with the application of a following described slurry seal coat

upon the so designated surface, complete in strict accordance with these specifications, applicable plans, the Special Provisions, and as directed by the Engineer.

A. Description - The slurry seal coat shall consist of a mixture of emulsified asphalt, mineral aggregate and water, properly proportioned, mixed, and spread on the surface as specified herein and as directed by the Engineer.

B. Materials -

1. Aggregates - Aggregate shall consist of natural or manufactured sand, slag, crusher fines, or other materials approved by the Engineer, blended with mineral filler, if necessary to meet the gradation requirements. Portland Cement, limestone dust, fly ash, or hydrated lime may be used as a filler, provided the blended gradation is within the requirements. The aggregate shall be clean and free of deleterious substances and shall have a plasticity index of not more than five (5) when tested in accordance with ASTM D424. Smooth-textured sand, whose water absorption is less than 1.25% when tested by ASTM C128, shall not exceed 50% of the total combined aggregate. The aggregate, when tested for soundness with Sodium Sulfate in accordance with ASTM C88, shall show a loss of not more than ten (10) percent.

The gradation of the combined aggregate, when tested by ASTM C136, shall meet the following requirements:

| Sieve Size | Percent Passing | | |
|------------|-----------------|----------|---------|
| | Type 1 | Type 2 | Type 3 |
| 3/8" | | 100 | 100 |
| #4 | 100 | 80 - 100 | 70 - 90 |
| #8 | 80 - 100 | 65 - 85 | 45 - 70 |
| #16 | 60 - 85 | 45 - 70 | 35 - 50 |
| #30 | 45 - 70 | 30 - 50 | 20 - 35 |
| #50 | 30 - 50 | 20 - 35 | 12 - 25 |
| #100 | 15 - 30 | 12 - 25 | 10 - 20 |
| #200 | 10 - 20 | 10 - 20 | 8 - 15 |

2. Water - Water shall be potable and free from harmful soluble salts and in accordance with Grand Island City water quality.
3. Emulsified Asphalt - The emulsified asphalt shall meet the requirements of ASTM D977 (anionic) or ASTM D2397 (cationic). The type and grade, including the penetration of the residual asphalt, will be as listed in the bid or as designated by the Engineer.

C. Slurry Mixture -

1. Mixture Proportions - The mixture shall contain from 14% to 22% asphalt emulsion for Type 1, 10% to 16% for Type 2, and 8% to 14% for Type 3, based on the weight of dry aggregate.

Only the amount of water will be used that is necessary to produce a fluid, creamy texture which will flow smoothly. The actual proportions to be used shall be determined by the Engineer.

2. Mixture Requirements - A free flowing creamy consistency, obtained by varying the quantity of water only, is required for proper application of the mix. The quantity of emulsified asphalt required shall not be altered unless directed by the Engineer. The Contractor shall make trial batches at his expense to determine the final blend of mineral aggregate, mineral filler, and asphaltic binder to be used for most adequate results and approval of the Engineer. Mixture shall be of such consistency as to flow in a wave of approximately two (2) feet ahead of strike-off squeegee.
3. Wearability - The mixture, when tested by the Standard Wet Track Abrasion Test, shall show a loss of not more than 1.5 pounds/square yard (75 gm./square foot).

D. Equipment -

1. Mixing Machine - The slurry seal coat mixing machine shall be a continuous flow mixing unit and be capable to accurately deliver and proportion aggregate, asphalt emulsion, and water to an approved mixer tank and discharge the thoroughly mixed product on a continuous basis from a minimum of two (2) minutes to a maximum of four (4) minutes mixing time.

The mixer shall be washed clean with water immediately after discharging the slurry. Any mixer which becomes clogged or caked with hardened material will be rejected by the Engineer until properly cleaned.

2. Spreader Box - The spreader box may incorporate numerous features but shall consist of at least a rectangular frame of traffic lane width with a squeegee across the box about three-fourths of the way back from the front. The squeegee shall be fastened to the bottom of the cross member which shall be sectional and adjustable for thickness of application and adjustable to the crown of the pavement in segments not over three (3) feet long. The squeegee shall be neoprene rubber belting one (1) inch thick and six (6) to eight (8) inches wide across the width of the box, bolted to the adjustable frame with at least four (4) inches of free face to provide sufficient flexibility in order to maintain contact with the pavement surface in depressions and compress sufficiently to pass over high spots. The front and sides of the spreader box shall be lined on the inside with heavy rubber belting secured by bolts and a heavy metal strip. The belting material shall be slotted at the holes so it can be raised or lowered to make contact with the pavement surface to prevent the slurry from escaping

from the bottom of the sides and front members. The spreader also shall be equipped with a guide wheel mounted on the side to force the box to follow the tow truck in a straight line. The spreader box shall also contain longitudinal or diagonal baffles to distribute the slurry the full length of the squeegee.

3. Miscellaneous Equipment - Long-handled, rubber-faced squeegees shall be constructed and have flexibility to permit uniform spreading of the slurry mixture. Power sweepers, air compressors, sprinkler trucks, distributor, weighing and measuring equipment shall be provided to accurately weigh and measure the ingredients of the mix. Where traffic is not sufficient to properly knead the mix into the cracks, a pneumatic tire roller shall be required to obtain the desired results.
- E. Preparation of Surface - The existing surface shall be thoroughly cleaned of all loose material, dirt, oil drippings, and other matter which may adversely affect proper bond of the slurry seal. Depressions and bumps shall be brought to proper grade and distressed areas shall be patched or otherwise repaired, as directed by the Engineer. When deemed necessary by the Engineer, the surfacing of the existing pavement and all crack faces shall be sprayed with diluted asphalt emulsion at a rate of 0.05 to 0.1 gallons per square yard and all surfaces shall be in a uniformly damp condition.
- F. Application and Spreading Slurry Mixture -
1. Application Rates - The slurry mixture shall be applied at the rate of seven (7) to thirteen (13) pounds/square yard for Type 2 and seventeen (17) to twenty-three (23) pounds/square yard for Type 3. The type to be used will be as listed in the bid or as designated by the Engineer.
 2. Spreading Requirements - The slurry mixture shall be chuted into the moving spreader box at a rate so that there is sufficient slurry in the box to cover the full width of the squeegee blade at all times. In restricted areas when hand spreading is necessary, the mixture shall be poured in a small windrow along one edge of the surface to be covered. The mix shall then be spread by means of a squeegee so as to permit the operator to drag it over the surface along the windrow with the edge of the squeegee at an angle to the direction of travel. Weighted sacks or burlap shall trail behind the spreader box to smooth joints between lanes. When hand spread, the surface shall be given this drag treatment if ridges are developed.
- G. Curing - The slurry seal coat shall be allowed to cure until firm and to a condition that no pick up of the mix will occur before permitting access to traffic or as directed by the Engineer.

- H. Weather Conditions - The slurry mixture shall not be applied if either the pavement surface or the local ambient temperature is 55 degrees Fahrenheit or below and falling, but may be applied when both the pavement and air temperature is 45 degrees Fahrenheit or above and rising. The mixture shall not be applied if high relative humidity prolongs the curing beyond a reasonable time, as determined by the Engineer.
- I. Basis of Payment - The emulsified asphalt slurry coat will be measured by the square yard and paid for at the contract unit price per square yard for the item "Slurry Coat." This price shall be considered full compensation for furnishing, mixing, hauling, and placing all materials, including all labor, equipment, tools, barricades, and other incidentals necessary to complete the work in full compliance with these specifications and in a workmanlike manner.

24.11 Asphalt Carpet Coat. This mixture is designed for the filling of small holes and depressions and for the provision of a wearing surface on asphaltic concrete pavements. The work shall consist of furnishing all plant, labor, equipment, placing of material, and performing all operations in connection with the application of asphalt carpet coat on existing asphaltic concrete pavement and in strict accordance with applicable sections of State of Nebraska specifications.

A. Composition of Mixture - This mineral aggregate shall conform to State of Nebraska specifications, within the following recommended limits:

| <u>Material</u> | <u>Percent of Mineral Aggregate</u> | <u>Percent of Total Mix</u> |
|------------------------------|---|---------------------------------|
| Limestone Screenings | 40 - 45 | |
| Crushed Gravel | 40 - 45 | |
| Fine Sand | 10 - 20 | |
| Asphalt Cement (80-100 pen.) | | 6 - 6.8 |

B. Properties and Tests - The mixtures shall have test properties conforming to State of Nebraska specifications.

C. Basis of Payment - The asphalt carpet coat shall be measured by weight in tons actually constructed and accepted by the Engineer and shall be paid for at the contract unit price per ton for the item "Asphalt Carpet Coat." The asphaltic mixture shall be weighed, after mixing, on scales accepted by the Engineer. The contract unit price shall be full compensation for furnishing all materials, including necessary tack coat and asphaltic cement. All equipment, scales, cleaning, sweeping, handling, mixing, placing, shaping, compacting, rolling, finishing, and incidentals necessary to complete the work required by these specifications.

24.12 Asphaltic Concrete Surface Course and Base Course. The asphaltic concrete surface course and base course shall conform to the most current State of Nebraska, Department of Roads, Standard Specifications for Highway Construction.

24.13 Pavement Removal. This work shall consist of the removal of existing pavement, surface courses, cushion courses, if any, driveways, sidewalks, curb or combination curb and gutter, and concrete headers. The work shall also include disposal of the resultant materials as provided in these specifications.

A. Removal and Disposal -

1. Breaking Concrete - The Contractor shall exercise due care in breaking concrete to be removed and shall be responsible for any damage caused by such breaking and removal.
2. Removal Limits - In removing existing pavement, sidewalks, driveways, and similar items where a portion of such item is to be left in place, the removal shall be extended to the limits shown on the plans or to an existing joint as directed by the Engineer. In the event the Engineer does not consider it practical to extend the limit of removal to an existing joint, the line of removal shall be scored with a concrete saw to a depth of at least two (2) inches prior to breaking out the concrete. Connecting edges shall be cut and chipped to true vertical faces.
3. Backfilling - All trenches, holes, and pits resulting from the removal of any of the items listed herein shall be backfilled if and as required with suitable material in accordance with the requirements of sections in these specifications in Division VI entitled Backfilling and Backfilling Under Pavement.
4. Disposal - Except as otherwise provided or noted on the plans, all materials obtained in the removal of items listed herein shall become the property of the Contractor and shall be disposed of by him in any manner acceptable to the Engineer.

B. Classification -

1. Remove Existing Pavement - This item shall consist of the removal and disposal of plain or reinforced concrete, brick, stone, block, or asphalt surfaced pavements and shall include base, surface, and cushion courses, if any, regardless of the material or materials encountered.
2. Remove Surface Course - This item shall consist of removing and disposing of asphaltic surfacing from concrete or crushed rock bases or from previously resurfaced brick or cobblestone surfaces, except asphaltic surfacing as defined in the following paragraph and the removal of brick or cobblestone surfacing, including cushion courses, if any.
4. Remove Asphalt Mat - This item shall consist of the removal and disposal of roadway surfacing of any one or any combination of the following:

- a. Gravel, crushed rock, cinder, or earth surfaced roadways which have acquired an asphaltic character through repeated dust palliative treatments with bituminous materials.
- b. Armor coated gravel or rock bases.
- c. Asphalt pavements of a temporary nature which may be similar to plant mix, hot or cold laid, or road mix asphaltic surfacing applied to previously existing gravel or rock surfacings.

The work involved herein shall be considered incidental to grading as set forth in the Standard Specifications, unless there is a contract unit price for this work.

- 4. Remove Driveway - This item shall consist of the removal and disposal of plain or reinforced concrete, brick, stone, block, or asphalt paved driveways. Removal of crushed rock, gravel, rubble, or cinder surfaced driveways will be considered incidental and will not be paid for separately.
- 5. Remove Curb - This item shall consist of the removal and disposal of stone or concrete separate curb or combination curb and gutter. Combination curb and gutter is defined as any integral concrete curb and gutter section whose combined total width is less than three (3) feet and which was not constructed integrally with an adjoining base or pavement. If the combined total width is three (3) feet or more, it shall be classified as pavement with integral curb. Integral curb will not be measured separately for payment but shall be included in the number of square yards of pavement or driveway, whichever is applicable, and no additional compensation shall be allowed except as provided in the following paragraph.
- 6. Remove Integral Curb - This item shall consist of removing and disposing of integral curb when it is desired to widen or provide new connections to an existing pavement or driveway with integral curb. It shall also include scoring the pavement or driveway to a depth of two (2) inches with a concrete saw parallel to and not less than one (1) foot nor more than three (3) feet from the back of curb as shown on the plans or directed by the Engineer. Connecting edges shall be cut and chipped to true vertical faces.
- 7. Remove Concrete Headers - This item shall consist of removing and disposing of concrete headers previously placed at the open ends of existing pavement.

C. Measurement and Payment -

- 1. General - When the contract does not include a separate item and unit price for removing any of the removal items listed herein, the Contractor will be paid for such items on the basis of the Engineer's Estimate of unit prices. Otherwise, such item or items shall be measured and paid for as follows:

- a. Removal of Surface Course - Will be measured for payment in square yards of material of whatever thickness actually removed and disposed of and shall be paid for at the contract unit price per square yard for the item "Remove Surface Course, Small Areas" or for the item "Remove Surface Course, Large Areas." Small areas shall consist of individual areas of sixty (60) square yards or less or areas having a lateral dimension of six (6) feet or less. Large areas shall consist of all individual areas which do not conform to the definition of small areas.
 - b. Removal of Existing Pavement - Will be measured in square yards of pavement or base actually removed of whatever thickness encountered and shall be paid for at the contract unit price for the item "Remove Existing Pavement, Small Areas" or for the item "Remove Existing Pavement, Large Areas." Small areas shall consist of individual areas of sixty (60) square yards or less or areas having a lateral dimension of six (6) feet or less. Large areas shall consist of all individual areas which do not conform to the definition of small areas.
 - c. Removal of Driveways - Shall be measured in square yards of driveway actually removed of whatever thickness encountered and shall be paid for at the contract unit price for the item "Remove Driveway."
 - d. Removal of Sidewalks - Shall be measured in square feet of sidewalk actually removed of whatever thickness encountered and shall be paid for at the contract unit price per square foot for the item "Remove Sidewalks."
 - e. Removal of Curbs, Integral Curbs, and Concrete Headers - Shall be measured for payment by length in lineal feet and shall be paid for at the contract unit price per lineal foot for the item "Remove Curb", for the item "Remove Integral Curb", or for the item "Remove Concrete Headers."
2. Compensation Requirement - Payment for the work at the contract unit price in each instance shall be full compensation for removing and disposing of the surplus material; the necessary excavation and backfilling; sawing, cutting, and chipping concrete as required; and for all labor, equipment, tools, materials, and incidentals which may be necessary to complete the work.

24.14 Miscellaneous Removals. This work shall include the removing of existing concrete or masonry steps and retaining walls, culverts, inlet or sewer pipe, manholes, other concrete and masonry structures, and other items of removal called for on the plans or bid forms and the salvaging and disposing of the resulting materials, together with the necessary excavation and backfilling.

A. Removal -

1. Concrete Structure - Concrete or masonry retaining walls and steps and other concrete and masonry structures shall be entirely removed to a depth of at least six (6) inches below subgrade, surface of cuts and slopes, or existing ground surface, whichever is the lower, and to the horizontal limits shown on the plans or as directed by the Engineer. When a portion of an existing retaining wall is to be left in place, the discontinued end of such wall shall be refaced in a manner which will match the original construction as nearly as possible and which, in the opinion of the Engineer, will present a neat and workmanlike appearance.
2. Culverts and Sewer Pipe - Driveway and roadway culverts and inlet and sewer pipe shall be completely removed at each location indicated in the plans or as directed by the Engineer and shall include all sizes up to and including 24 inch diameter regardless of the material or materials of which they are made. For any culvert or sewer pipe over 24 inches in diameter, the size will be indicated in the bid for that particular item of removal.
3. Manholes and Inlets - In removing manholes or inlets, any sewer pipes connecting to them shall be preserved or rebuilt as required when the plans call for extensions to these pipes. When the existing pipe connections are to be abandoned, they shall be plugged with concrete or by any other device satisfactory to the Engineer. Manholes and inlets need not be completely removed, providing they are broken down to at least six (6) inches below subgrade, surface of cuts and slopes or existing ground surface, whichever is the lower. The remainder of the manhole or inlet structure shall then be cleaned of all rubble and debris and backfilled with suitable earth as provided in City Code Section 32.32.

B. Disposal - All materials resulting from the removal of the items listed herein or indicated in the bid to be removed shall be hauled from the project site and disposed of by the Contractor in a manner satisfactory to the Engineer, except that items deemed salvable by the Engineer shall remain the property of the City, such as culverts in good condition or inlet and manhole castings, and shall be stored on the project site for subsequent removal by the City.

C. Measurement and Payment -

1. Concrete Structures - Removal of concrete and masonry retaining walls and other concrete and masonry structures shall be measured by the cubic yard actually removed and disposed of and shall be paid for at the contract unit price per cubic yard for the item "Remove Concrete and Masonry."

2. Culvert and Sewer Pipe - Removal of culverts and inlet and sewer pipes shall be measured by length in lineal feet actually removed and disposed of and shall be paid for at the contract unit price per lineal foot for the item "Remove Culvert" or for the item "Remove Sewer Pipe" whichever is applicable. For any culvert or pipe over 24 inch diameter, the size of the removal item will be indicated in the bid for that particular item to be removed.
 3. Manholes and Inlets - Removal of manholes and inlets shall be measured by the number of units actually removed and shall be paid for at the contract unit price per each for the item "Abandon Inlet" or for the item "Abandon Manhole" whichever is applicable.
 4. Other items - All other items of removal called for on the plans and in the bid forms will be measured in units as indicated thereon and shall be paid for at the contract price for such items.
 5. Compensation Requirement - In each instance, measurement shall include the total quantity actually removed and accepted by the Engineer and the contract unit price shall be full compensation for removing; disposing of surplus material; all necessary excavation and backfilling; sawing, cutting, and chipping edges; refacing retaining walls; and for all labor, equipment, tools, materials, and all other incidentals necessary to complete the work as shown in the plans and specifications.
- D. Remove and Replace Mail Boxes and Posts - This item shall consist of removing and resetting mail boxes and posts in the locations directed by the Engineer. Any elements of the mail boxes or posts damaged by the Contractor shall be repaired or replaced as directed by the Engineer at the Contractor's expense.
1. Furnishing Posts - When a mail box post is unsuitable for reuse, not due to the Contractor's negligence, the Contractor will furnish and install new posts satisfactory to the Engineer and payment will be made as per contract documents.
 2. Measurement and Payment - Removal and resetting of mail boxes and posts shall be measured as single units actually removed and replaced and shall be paid for at the contract unit price per each for item "Remove and Replace Mail Boxes." This price shall be full compensation for removing and resetting and for all labor, equipment, tools, and incidentals necessary to complete the work required for this item. Single unit shall mean a single post, regardless of the number of mail boxes on that particular post.

24.15 Special Provisions. See Special Provisions for asphaltic construction.

DIVISION V

STORM AND SANITARY SEWER

**DIVISION V
STORM AND SANITARY SEWERS**

C O N T E N T S

| SECTION | DESCRIPTION |
|-----------|---|
| 25 | SCOPE OF WORK |
| 26 | MATERIALS |
| 26.01 | Reinforced Concrete Pipe |
| 26.02 | Concrete Pipe Joints |
| 26.03 | Vitrified Clay Pipe |
| 26.04 | Vitrified Clay Pipe Factory-Fabricated Joints |
| 26.05 | Cast Iron Pipe and Fittings |
| 26.06 | Cast Iron Pipe Joints |
| 26.07 | Portland Cement Concrete |
| 26.08 | Reinforcement |
| 26.09 | Structural Brick |
| 26.10 | Storm Sewer Inlet Frames and Grates |
| 26.11 | Manhole Rings and Cover |
| 26.12 | Grout |
| 27 | CONSTRUCTION METHODS |
| 27.01 | Excavation |
| 27.02 | Protection of Existing Utilities |
| 27.03 | Pipe Laying and Jointing |
| 27.04 | Manholes |
| 27.05 | Storm Sewer Inlets |
| 27.06 | Pipe Bedding |
| 27.07 | Trench Backfill |
| 27.08 | Backfilling Under Pavement |
| | Revised 6-25-2021 |
| 27.09 | Nonshrinkable Backfill |
| | Revised 6-25-2021 |
| 27.10 | Stacks |
| 27.11 | Separation from Water Mains |
| 27.12 | Testing |
| 27.13 | Exfiltration and Air Testing |
| 27.14 | Television Inspection |
| | Revised 2-1-2009 |
| 27.15 | Exposure of Pipe or Manholes |
| 28 | DRAINAGE STRUCTURE CONSTRUCTION |
| 28.01 | Concrete Work |
| 28.02 | Brick Work |
| 28.03 | Precast Manhole Sections |
| 28.04 | Acceptance |
| 29 | METHOD OF MEASUREMENT AND BASIS OF PAYMENT |
| 29.01 | Sewer Pipe in Place |
| 29.02 | Wyes |
| 29.03 | Manholes |
| 29.04 | Storm Sewer Inlets |

DIVISION V STORM AND SANITARY SEWERS

This division is written so that ordinarily the type of construction described is complete but, where applicable, other divisions are considered a part of this specification.

SECTION 25 - SCOPE OF WORK

The work covered by this division of the specifications consists of furnishing all labor, plant, equipment, appliances, and materials and performing all operations necessary to construct and complete storm and sanitary sewers and appurtenances in strict accordance with these specifications, the applicable drawings, and subject to the terms and conditions of the contract.

SECTION 26 - MATERIALS

26.01 Reinforced Concrete Pipe. All reinforced concrete pipe shall meet the requirements and specifications of Reinforced Concrete Culvert, Storm Drain and Sewer Pipe, ASTM C76, Class III, and subsequent revisions, or as otherwise shown in the plans.

26.02 Concrete Pipe Joints.

1. Rubber Joint Filler. Rubber based joint filler shall be used on all concrete pipe joints unless otherwise specified.
2. Gasket Type Joints. When gasket type joints are required, they shall be as follows: Bell and Spigot Pipe Joints, ASTM C361, and subsequent revisions
Tongue and Groove Pipe Joints, ASTM C443, and subsequent revisions.

26.03 Vitrified Clay Pipe. All vitrified clay pipe shall meet the requirements and specifications for Extra Strength Clay Sewer Pipe conforming to ASTM C700 or C425 compression joint and subsequent revisions, or as otherwise shown on the plans.

26.04 Vitrified Clay Pipe Factory-Fabricated Joints. All vitrified clay pipe shall have O-ring gasket factory-fabricated joints that meet the requirements and specifications for Vitrified Clay Pipe Joints Using Materials Having Resilient Properties, ASTM C700 and subsequent revisions or as otherwise shown on the plans.

26.05 Cast Iron Pipe and Fittings. See Division VI, Water Mains.

26.06 Cast Iron Pipe Joints. See Division VI, Water Mains.

26.07 Portland Cement Concrete. The concrete shall be air-entrained as specified in Division III, Curb and Gutter, Sidewalks, and Driveways, in the section entitled Materials -- Sand-Gravel.

26.08 Reinforcement. The deformed bars that are used in reinforcing shall be Type B, Grade 2.

26.09 Structural Brick. Bricks shall be of the type that are satisfactory to the Engineer and shall be laid in 1:2 cement mortar.

26.10 Storm Sewer Inlet Frames and Grates. The frames and grates shall be of cast iron with tensile strength test not less than Class 25.

26.11 Manhole Rings and Covers. Unless shown otherwise on the plans, the rings and covers for manholes shall be 450 pound cast iron machined rings and covers with tensile strength test not less than Class 25.

26.12 Grout. Grout, where required, shall consist of equal parts of sand and cement with sufficient water to produce the proper consistency.

26.13 Manholes. All concrete used in the construction of manholes shall be in accordance with the following Sulfate Resistant Concrete Specifications, Section 26.14, dated March 20, 2002. This shall include all concrete used in the construction of pre-case manholes, manhole bases, and manhole inverts.

26.14 Sulfate Resistant Concrete Specifications

March 20, 2002
SUBMITTALS

A. Shop Drawings:

1. Curing compound data
2. Complete data on the concrete mix, including aggregate gradations and admixtures, in accordance with ASTM C94

B. Quality Control Submittals:

1. Manufacturer's application instructions for curing compound.
2. Ready-mix delivery tickets for each truck in accordance with ASTM C94.

QUALITY ASSURANCE

- A. Concrete and Reinforcement: Unless otherwise specified. Meet the requirements of ACI 301 and 318/318R
- B. Precast Reinforced Concrete: Unless otherwise specified. Meet the requirements of ASTM C478
- C. Formwork: Unless otherwise specified, follow the recommendations of ACI 347.
- D. Hot Weather Concreting: Conform to ACI 305R
- E. Cold Weather Concreting: Conform to ACI 306R

ENVIRONMENTAL REQUIREMENTS

- A. Do not place Concrete when the ambient temperature is below 40 degrees F or approaching 40 degrees F and air temperature less than 40 degrees F for the first 7 days, without special protection to keep Concrete above 40 degrees F.
- B. Do not use curing compound where solvents in the curing compounds are prohibited by state or federal air quality laws. Use only water curing methods.

CONCRETE

- A. Ready-mixed meeting ASTM C94, Option A.
- B. Portland Cement: ASTM C595, Type IP containing less than 8 percent tricalcium aluminate.
- C. Admixtures:
 - 1. Air-Entraining; ASTM C260.
 - 2. Water-Reducing; ASTM C494, Type A or D.
 - 3. Superplasticizer: ASTM C494, Type for G.
 - 4. Fly Ash: ASTM C618, Class C or F; not to exceed 25% total pozzolan by weight.
- D. Mix Design:
 - 1. Minimum Allowable 28 day Compressive Field Strength: 4,000 psi when cured and tested in accordance with ASTM C31 and C39.
 - 2. Coarse Aggregate Size: 0.5-inch and smaller, 40% Limestone by volume minimum; State of Nebraska approved source.
 - 3. Water/Cement Ratio: 0.38%.
 - 4. Air Entrainment: Between 5.0 to 7.5%.
 - 5. Water Reducers: Use in all concrete as per manufactures recommended guidelines.
 - 6. Suerplasticizer: Use in all walls. Use in slabs at CONTRACTOR's option.
 - 7. Slump Range: 1 to 4 inches; before addition of Suerplasticizer.
 - 8. Slump Range: 5 to 9 inches; after addition of Suerplasticizer.
- E. Mixing: Minimum 70 and maximum 270 revolutions of mixing drum. Nonagitating equipment is not allowed.

REINFORCING STEEL

- A. Deformed Bars: ASTM A615, Grade 60.

ANCILLARY MATERIALS

- A. Nonshrink Grout:
 - 1. Color: To match concrete.
 - 2. Manufacturers and Products
 - a. Master Builders Co., Cleveland, OH; Master Flow 928.
 - b. Euclid Chemical Co., Cleveland, OH; Hi-flow Grout
 - c. Or equal
- B. Grout for Slipliner Invert Rehabilitation:
 - 1. Description: Rapid strength repair mortar.
 - 2. Final Set Time: 20 to 36 minutes.
 - 3. Manufacturers and Products:
 - a. Master Builders Co., Cleveland, OH; EMACO T415
 - b. Or equal

C. Protective Epoxy Coating for Exposed Grout at Slipliner Invert Rehabilitation:

1. Strong Seal System by Johnson Service Co.; Kearney, NE 68848

D. Curing Compound: Required for Cast In Place Concrete

1. Material: Solvent based containing chlorinated rubber solids in accordance with ASTM C309, with additional requirements that the moisture loss not exceed 0.030 grams per centimeter squared per 72 hours.
2. Manufacturers and Products:
 - a. Master Builders Co., Masterkure N Seal HS.
 - b. Euclid Chemical Co.; Euco Super Floor Coat.
 - c. Or Equal

FORMWORK

A. Form Material

1. Use hard plastic finished plywood for exposed areas, and new shiplap or plywood for unexposed areas.
2. Earth cuts may be used for forming footings.

B. Form Ties:

1. Fixed conical or spherical type inserts that remain in contact with forming material and allow for dry packing of form ties holes.
2. Ties shall withstand pressures and limit deflection of forms to acceptable limits.
3. Wire ties are not acceptable.

C. Construction:

1. In accordance with ACI 347.
2. Make joints tight to prevent escape of mortar and to avoid formation of fins.
3. Brace as required to prevent distortion during concrete placement.
4. Brace as required to prevent distortion during concrete placement.
On exposed surfaces locate form ties in uniform pattern or as shown. Construct so ties remain embedded in the wall with no metal within 1 inches of concrete surface when forms, inserts, and tie ends are removed.

D. Form Removal:

1. Remove forms with care to prevent scarring and damaging the surface.

PLACING REINFORCING STEEL

A. Unless otherwise specified, place reinforcing steel in accordance with CRSI Recommended practice for placing Reinforcing Bars.

B. Splices and Laps:

1. Top Bars: Horizontal bars placed such that 12 inches of fresh concrete is cast below in single placement.
2. Horizontal wall bars are considered top bars.
3. Laptop bars 42 diameters or minimum 24 inches.
4. Lap all other bars 30 diameters or minimum 18 inches. Tie splices with 18-gauge annealed wire as specified in CRSI Standard

PLACING CONCRETE

- A. Place concrete in accordance with ACI 301.
- B. Prior to placing concrete, remove water from excavation and debris and foreign material from forms. Check reinforcing steel for proper placement and correct discrepancies.
- C. Before depositing new concrete on old concrete, clean surface using sandblast or bush hammer or other mechanical means to obtain a ¼-inch rough profile.
- D. Place concrete as soon as possible after leaving mixer, without segregation or loss of ingredients, without splashing forms or steel above, and in layers not over 2 feet deep. Place within 1-1/2 hours after adding cement mix.
- E. 8 feet maximum vertical drop to final placement, when not guided with chutes or other devices to prevent segregation due to impact with reinforcing.

COMPACTION

- A. Vibrate concrete as follows:
 - 1. Apply approved vibrator at points spaced not farther apart than vibrator's effective radius.
 - 2. Apply close enough to forms to vibrate surface effectively but not damage form surfaces.
 - 3. Vibrate until concrete becomes uniformly plastic.
 - 4. Vibrator must penetrate fresh placed concrete and into previous layer of fresh concrete below.

CONSTRUCTION JOINTS

- A. Locate as shown or as approved.

FINISHING

- A. Floor Slabs and Tops of Walls
 - 1. Screed surface to true level planes.
 - 2. After initial water has been absorbed, float with wood float and trowel with steel trowel to smooth finish free from trowel marks.
 - 3. Do not absorb wet spots with neat cement.
- B. Unexposed Slab Surfaces: Screed to true surface, bull float with wood float, and wood trowel to seal surface.

PROTECTION AND CURING

- A. Protect fresh concrete from direct rays of sunlight, drying winds, and wash by rain.
- B. Keep concrete slabs continuously wet for a 7-day period. Intermittent wetting is not acceptable or use curing compound only where approved by ENGINEER. Cure formed surfaces with curing compound applied in accordance with manufacturer's directions as soon as forms are removed and finishing is completed.
- C. Remove and replace concrete damaged by freezing.

FIELD TESTS

A. Evaluation of Concrete Field Strength: In accordance with ACI 318/318R

. Revised 5-28-2003

SECTION 27 - CONSTRUCTION METHODS

27.01 Excavation. The ditch shall be excavated along the lines and to the depth as designated by the Engineer. The Contractor shall furnish, at Contractor's expense, all planks, stakes, spikes, grade boards, and twine that may be required. The Engineer shall have the right to limit the amount of trench that may be opened in advance of the line of work. Should the trench be excavated to a greater depth than that given by the Engineer, the Contractor shall refill to grade, at Contractor's expense, with good, well-tamped material. Trenches, where required, shall be properly sheeted and braced. The bottom of the trench under each pipe shall be shaped to receive the bottom quadrant of the pipe barrel. Bell holes shall be excavated so, after placement, only the barrel of the pipe receives bearing pressure from the trench bottom.

Whenever wet or unstable soil that is incapable of properly supporting the pipe, as determined by the Engineer, is encountered in the trench bottom, such soil shall be removed to the depth and length determined by the Engineer and the trench backfilled to grade with sand, gravel, or other suitable material.

All grading in the vicinity of trench excavation shall be controlled to prevent surface water from flowing into the trench. Any water accumulating in the trench shall be removed by pumping or other approved method. Material excavated from the trench shall be stacked in an orderly manner a sufficient distance back from the edge of the trench to avoid overloading and to prevent slides or cave-ins. Materials unsuitable for backfilling shall be wasted by the Contractor as directed by the Engineer.

A minimum of one foot of topsoil (unless otherwise noted on the plans) shall be removed in any and all areas covered by vegetation. This topsoil shall be stockpiled separately from the material removed from the remainder of the trench. After the pipe is installed and the trench backfilled to an elevation one foot (unless otherwise noted on the plans) below grade, the topsoil shall be replaced and compacted as previously described.

Excavation will not be classified. Whatever material is encountered shall be excavated to the proper grades and, if in any location such material is not sufficient to provide a uniform, even bed for the pipe, the trench shall be excavated at least three (3) inches deeper than the grade at the bottom of the pipe and the space thus excavated shall be refilled with earth or sand and thoroughly compacted.

Trench excavation shall not be paid for separately but shall be considered incidental to the sewer in place.

27.02 Protection of Existing Utilities. The accuracy of location of existing underground utilities as shown on the plans is not guaranteed. It shall be the duty of the Contractor to locate these utilities in advance of excavation and to protect them from damage after uncovering. No house service lines are shown on the plans. The Contractor shall contact the owners of the utilities for assistance in locating these service lines. Any expense incurred by reason of damaged or broken lines shall be the responsibility of the Contractor.

Pipe Laying and Jointing. Pipe shall be protected at all times against impact shocks and free fall. Laying of pipe in finished trenches shall be commenced at the lowest point with the spigot ends on bell-and-spigot pipe and tongue ends on tongue-and-groove pipe pointing in the direction of the flow. Pipe shall be set firmly to line and grade and, preparatory to making pipe joints, all surface of the pipe to be jointed shall be cleaned and dried. Joints shall be made tight to meet requirements of tests specified in the section of these specifications entitled Exfiltration, Infiltration, and Air Testing.

Sewer trenches shall be kept free from water by a method approved by the Engineer. The Contractor shall not pump sewage into a street or pump to a storm sewer unless authorized by the Engineer. Sanitary sewage must be returned to the sanitary sewer by means of pipe and hoses unless it is impossible to do so. In that instance, disposal must be approved by the Engineer.

27.04 Manholes. Manholes shall be constructed as indicated on the plans. Tops shall be fitted with cast iron rings and covers weighing approximately 450 pounds and satisfactory to the Engineer. Manholes over three (3) feet in depth shall be equipped with cast iron steps placed on approximately sixteen (16) inch centers. Drop inlet manholes shall be constructed where indicated on the plans.

Manholes of Precast sections conforming to ASTM C478 specifications may be used.

27.05 Storm Sewer Inlets. Storm sewer inlets shall be of the type as shown on the plans and constructed as per the detailed drawings.

27.06 Pipe Bedding. For Class "C" bedding, the space between the pipe and the side of the excavation up to one (1) foot above the top of the pipe shall be filled with sand or fine earth in layers of not more than six (6) inches thick and carefully tamped to form a solid bedding.

For Class "B" bedding, the trench shall be backfilled with a granular fill of crushed stone or pea gravel to an elevation which is half the diameter of the pipe, and the remaining distance from half the diameter of the pipe to one (1) foot above top of pipe shall be a tamped backfill as specified for Class "C" bedding. The granular fill shall have not less than 95% passing 1/2" and not less than 95% retained on a #4 sieve, shall be placed in not more than six (6) inch layers and compacted by slicing with a shovel.

27.07 Trench Backfill. The area more than one foot over the top of pipe shall be designated as trench backfill. Trenches shall not be backfilled until all required tests are performed and until the system installed conforms to the requirements of the plans and specifications. The trenches shall then be carefully backfilled up to one foot above the top of the pipe as specified in the section entitled Pipe Bedding. The balance of the excavated material shall be consolidated in the following manner. As backfilling proceeds, the entire mass shall be vibrated with a mechanical vibrator, provided, however, in all locations where plastic soils are encountered, the backfill material shall not be placed until the moisture content is low enough to obtain maximum density when tamped into place with mechanical tampers. Materials for tamped backfill and the method of placement and compaction thereof shall be specified for Class "C" pipe bedding. The completion of the trench backfill under pavement shall be done according to the section of these specifications entitled Backfilling Under Pavement.

Trench backfill and compaction testing shall adhere to the following requirements:

- A. Public Right-of-Way: Backfill shall be compacted to at least 95% of the maximum dry density (obtained at optimum moisture content plus or minus 2% for silt or clay with no required moisture content for sand) as determined by AASHTO Method T99. The minimum frequency shall be one test for every 12" compacted lift for an area or length worked, but no more than 300' apart. A minimum of one test shall be taken for every 12" compacted lift for each street crossing regardless of the length.

- B. Public Utility Easement: Backfill shall be compacted to at least 90% of the maximum dry density (obtained at optimum moisture content plus or minus 2% for silt or clay with no required moisture content for sand) as determined by AASHTO Method T99. The frequency shall be the same as that for public right-of-way. A minimum of one test shall be taken for every 12" lift for each easement crossing, regardless of the length.

The Engineer in charge shall be furnished a copy of the density testing results. Information on length or area worked, material identification and description, test thickness such as probe length or sample depth, location of sample, elevation of sample, etc. shall be recorded for each sample.

In unimproved areas such as easements and alleys, the trench or opening may be backfilled with sand which shall be flushed into place with water, provided the top twelve (12) inches of backfill shall be made of the excavated topsoil.

No separate or additional payment will be made for backfill compaction and density testing.

27.08 Backfilling Under Pavement. Standard backfill methods shall be as specified in the section of these specifications entitled Trench Backfill. When standard backfill methods are used, density tests will be required for each twelve (12) inch lift of compacted material placed and for each 300 lineal feet of trench regardless of the length Density test results shall be submitted to the Engineer before acceptance of the project by the City. Use of nonshrinkable backfill may be required or may be requested for substitution of standard backfill methods by the Contractor under all street sections, existing or proposed, with the approval of the Director Public Works.

Trenches shall not be backfilled until all required tests are performed and the system conforms to the plans and specifications. The Contractor shall maintain the sewer trench backfill for one (1) year from the date of acceptance of the project by the City.

Revised 6-25-2021

27.09 Nonshrinkable Backfill. All excavations where a sidewalk, curb, gutter, or paved street has been cut or where new paving (concrete or asphalt) will be placed may be backfilled using nonshrinkable backfill per Section 27.08. The backfill shall be filled to the subgrade of the undisturbed sidewalk, curb, gutter, paving, or earth surface.

The nonshrinkable backfill shall be a mixture of sand, gravel, Portland cement, and water (such as State of Nebraska Department of Transportation Standard Specifications for Highway Construction, Section 1003.02) which flows easily around the utility being covered and develops a 28 day compressive strength of from 30 to 200 psi. No nonshrinkable backfill mix designs shall be used without the approval of the Director of Public Works. Fly ash may be approved in the mix if test data are submitted to indicate the above characteristics are met.

Revised 6-25-2021

27.10 Stacks. Where indicated on the plans or directed by the Engineer, six (6) inch stacks will be furnished and constructed complete with clay stoppers to within ten (10) feet of ground surface or above underground water surface. All stacks will be constructed in accordance with the standard plan entitled Stack Construction Details in Division VIII, Standard Plan Drawings.

A separate stack shall be constructed for each house connection and in no case shall two service connections be connected to the same stack.

27.11 Relation to Water Mains.

Horizontal and Vertical Separation. Sewers shall be laid at least 10 feet horizontally from any existing or proposed water main. The distance shall be measured edge to edge. In cases where it is not practical to maintain a 10 foot separation, the appropriate reviewing agency may allow deviation on a case-by-case basis, if supported by data from the design engineer. Such deviation may allow installation of the sewer closer to a water main, provided that the water main is in a separate trench or on an undisturbed earth shelf located on one side of the sewer and at an elevation so the bottom of the water main is at least 18 inches (460 mm) above the top of the sewer.

If it is impossible to obtain proper horizontal and vertical separation as described above, both the water main and sewer must be constructed of slip-on or mechanical joint pipe complying with public water supply design standards of the agency and be pressure tested to 150 psi (1034 kPa) to assure watertightness before backfilling.

Crossings. Sewers crossing water mains shall be laid to provide a minimum vertical distance of 18 inches (460 mm) between the outside of the water main and the outside of the sewer. This shall be the case where the water main is either above or below the sewer. The crossing shall be arranged so that the sewer joints will be equidistant and as far as possible from the water main joints. Where a water main crosses under a sewer, adequate structural support shall be provided for the sewer to maintain line and grade.

When it is impossible to obtain proper horizontal and vertical separation as stipulated above, one of the following methods must be specified:

- a. The sewer shall be designed and constructed of PVC pipe and equal to water pipe, and shall be pressure tested at 150 psi (1034 kPa) to assure water tightness prior to backfilling.
- b. Either the water main or the sewer line may be encased in a watertight carrier pipe which extends 10 feet (3 m) on both sides of the crossing, measured perpendicular to the water main. The carrier pipe shall be of materials approved by the regulatory agency for use in water main construction.

Revised 2-01-2002

27.12 Testing. Upon completion of sewer, each pipe line and manhole will be tested as specified by the Engineer in charge. The Contractor shall furnish such tools, hose, and other equipment necessary for making such tests and shall be present during the inspection to note any deficiencies that may exist. Before final acceptance, all sewers shall be clean, shall comply with the specifications and all contract documents, and shall be acceptable to the Engineer and municipal authorities.

27.13 Exfiltration and Air Testing. Both the sewer pipe line and the manholes shall be tested. Manholes shall be exfiltration tested only. Sewer pipe lines shall be air tested only.

The first line between manholes shall be tested before backfilling and before any sewer pipe is installed in the remainder of the work. Thereafter, individual or multiple lines (optional to the Contractor with approval of the Engineer) shall be tested.

Exfiltration Test. This test shall be performed according to stated procedures and under the supervision of the Engineer. The test shall be conducted by blocking off all manhole openings, filling the manhole, and measuring the water level in the manhole for reference. The head above the pipe invert shall be about ten (10) feet. The head shall not exceed twenty-five (25) feet or be less than five (5) feet. The parameters for infiltration are similar. When the ground water level is above the pipe invert, the head shall be measured from ground water elevation. The total exfiltration shall not exceed 100 gallons per inch of diameter per mile of pipe per day. Manholes shall be considered as sections of 48 inch or 60 inch pipe. The exfiltration test shall be maintained for at least two (2) hours or as long as necessary to locate all leaks, as directed by the Engineer. If the leakage in any reach exceeds the allowable maximum, it shall be retested after the leaks are repaired.

Revised 5/20/2021

Air Test. This test shall be performed according to stated procedures and under the supervision of the Engineer.

Equipment used shall meet the following minimum requirements: (a) Pneumatic plugs shall have a sealing length equal to or greater than the diameter of the pipe to be tested, (b) pneumatic plugs shall resist internal testing pressure without requiring external bracing or blocking, (c) all air used shall pass through a single control unit, and (d) individual hoses shall be used for the following connections: (1) from control unit to pneumatic plugs for inflation, (2) from control unit to sealed line for introducing the low pressure air, and (3) from sealed line to control unit for continually monitoring the air pressure inside the pipe being tested.

Procedures: All pneumatic lugs shall be seal tested before being used in the actual test installation. One length of pipe shall be laid on the ground and sealed at both ends with the pneumatic plugs to be checked. Air shall be pressurized to 25 psig. The sealed pipe shall be pressurized to 5 psig. The plugs shall hold against this pressure without movement of the plugs out of the pipe.

After a manhole to manhole reach of pipe has been backfilled and cleaned and the pneumatic plugs are checked by the above procedures, the plugs shall be placed in the line at each manhole and inflated to 25 psig. Low pressure air shall be introduced into this sealed line until the internal air pressure reaches 4 psig greater than the average back pressure of any ground water that may be over the pipe.

After a manhole to manhole reach of pipe has been backfilled and cleaned and the pneumatic plugs are checked by the above procedures, the plugs shall be placed in the line at each manhole and inflated to 25 psig. Low pressure air shall be introduced into this sealed line until the internal air pressure reaches 4 psig greater than the average back pressure of any ground water that may be over the pipe.

At least two (2) minutes shall be allowed for the air pressure to stabilize.

After the stabilization period (3.5 psig minimum pressure in the pipe), the air hose from the control unit to the air supply shall be disconnected. The portion of line being tested shall be termed "acceptable" if the time required in minutes for the pressure to decrease from 3.5 to 3.0 psig (greater than the average back pressure of any ground water that may be over the pipe) shall not be less than the time shown for the given diameters in the following table:

| | | | | SPECIFICATION TIME FOR LENGTH (L) SHOWN (MIN:SEC) | | | | | | | | |
|--------------------------------|---------------------------------------|---|---|---|-----------|-----------|-----------|-----------|-----------|-----------|--------|--|
| 1 Pipe Diameter (in.) | 2 Minimum Time (Min: sec) | 3 Length for Minimum Time (ft) | 4 Time for Longer Length (sec) | 100 FT | 150 FT | 200 FT | 250 FT | 300 FT | 350 FT | 400 FT | 450 FT | |
| 4 | 1:53 | 597 | .190L | 1:53 | 1:53 | 1:53 | 1:53 | 1:53 | 1:53 | 1:53 | 1:53 | |
| 6 | 2:50 | 398 | .427L | 2:50 | 2:50 | 2:50 | 2:50 | 2:50 | 2:50 | 2:51 | 3:12 | |
| 8 | 3:47 | 298 | .760L | 3:47 | 3:47 | 3:47 | 3:47 | 3:48 | 4:26 | 5:04 | 5:42 | |
| 10 | 4:43 | 239 | 1.187L | 4:43 | 4:43 | 4:43 | 4:57 | 5:56 | 6:55 | 7:54 | 8:54 | |
| 12 | 5:40 | 199 | 1.709L | 5:40 | 5:40 | 5:42 | 7:08 | 8:33 | 9:58 | 11:24 | 12:50 | |
| 15 | 7:05 | 159 | 2.671L | 7:05 | 7:05 | 8:54 | 11:08 | 13:21 | 15:35 | 17:48 | 20:02 | |
| 18 | 8:30 | 133 | 3.846L | 8:30 | 9:37 | 12:49 | 16:01 | 19:14 | 22:26 | 25:38 | 28:51 | |
| 21 | 9:55 | 114 | 5.235L | 9:55 | 13:05 | 17:27 | 21:49 | 26:11 | 30:32 | 34:54 | 39:16 | |
| 24 | 11:20 | 99 | 6.837L | 11:24 | 17:57 | 22:48 | 28:30 | 34:11 | 39:53 | 45:35 | 51:17 | |
| 27 | 12:45 | 88 | 8.653L | 14:25 | 21:38 | 28:51 | 36:40 | 43:16 | 50:30 | 57:42 | 64:89 | |
| 30 | 14:10 | 80 | 10.683L | 17:28 | 26:43 | 35:37 | 44:31 | 53:25 | 62:19 | 71:13 | 80:07 | |
| 33 | 15:35 | 72 | 12.926L | 21:33 | 32:19 | 43:56 | 53:52 | 64:38 | 75:24 | 86:10 | 96:57 | |
| 36 | 17:00 | 66 | 15.384L | 25:39 | 38:28 | 51:17 | 64:06 | 76:55 | 89:44 | 102:34 | 115:23 | |

In areas where ground water is known to exist, the Contractor shall determine the water elevation prior to running the test. The height of water over the invert of the pipe shall be divided by 2.3 to establish the pounds of pressure that will be added to all readings. For example, if the height of the water is 11-1/2 feet, then the added pressure will be 5 psig. This increases the 3.5 psig to 8.5 psig and the 3.0 psig to 8.0 psig. The allowable drop of one half pound and the timing remain the same. For safety reasons, do not exceed 9.0 psig.

If the installation fails to meet this requirement, the Contractor shall, at Contractor's expense, determine the source of the leakage. Contractor shall then repair or replace all defective materials and/or workmanship. Air testing shall then be performed on the repaired line to meet the above specifications.

27.14 Television Inspection. Television inspection shall be required to determine if any defects exist prior to final acceptance. A minimum of 30 days shall lapse between completion of construction and television inspection.

Mobile closed circuit television inspection equipment shall be used to televise sewer lines between manholes. The camera shall be pulled through the line. Push type cameras are not acceptable. Robotic type camera equipment shall be used to televise stubouts.

Revised 2-06-2002

The television camera used for the inspection shall be a color camera specifically designed and constructed for such inspection. Lighting for the camera shall be suitable to allow a clear picture for the entire periphery of the pipe. Picture quality and definition shall be satisfactory to the Engineer. Inspection operations shall cease if the quality of the image on the screen is unsatisfactory. No payment will be made for unsatisfactory inspections.

A continuous image for viewing shall be produced. The images shall be of first rate quality according to the currently accepted standards for television inspection of sewers. A system, which displays the camera location in feet on the monitor with respect to the starting manhole's centerline, shall be used. This system shall automatically update the camera location display as the camera is pulled forward or backward through the sewer line.

Measurement for location of observations to be recorded shall be made at the ground level by means of a meter device. Measurement meters shall be accurate to one-half (0.5) foot. Measurements shall be referenced from the center of the manhole where the camera is started to the center of the manhole where observations are terminated. The measurements shall be checked at the completion of the observations by measuring the distance between manhole centers at the ground level. The observed measurements made by the meter and the ground level measurements shall correspond to within plus or minus one foot. Surface measurements shall be made by the contractor in the presence of the Engineer's representative.

The television camera shall be moved through the line at a uniform slow rate. During the inspection the camera shall be stopped at the points where one or more of the following conditions are observed and distances recorded.

1. Service line tees, wyes or taps.
2. Infiltration/inflow sources.
3. Structural defects, including broken pipe, collapsed pipe, cracks, punctures, settling, etc.
4. Abnormal joint conditions, such as horizontal and vertical misalignment, open joints, joints not fully sealed, etc.
5. Unusual conditions.

All such conditions shall be photographed as determined by the Engineer. Photographs of all questionable conditions shall be taken for subsequent review. The photographs shall be taken from the image on the TV monitor with a Polaroid, a 35 mm camera, or other approved methods. Before taking the photographs, the TV camera shall be properly positioned so the optimum view can be obtained. The image size of photographs shall be no smaller than three inches by four inches.

All photographs shall be identified by location, date taken, and names of the owner's and Contractor's representative. The location of all photographs shall be identified by recording the distance from each defect or point of interest to the center of the reference manhole. All photographs shall be submitted as specified.

A DVD/CD with a clear and audible voice narrative of the entire TV monitoring shall be furnished. Each disk will be delivered to the Engineer in charge. Each disk shall be titled on the screen with the date, manhole numbers, pipe size, district or project number. The camera shall be set to begin at the center of the manhole and the footage zeroed out.

Revised 2-06-2002

The title shall change at each manhole and the footage zeroed out again before starting a new pull when more than one section of sewer is televised in succession. Defects in the sewer line shall be repaired or replaced by the Contractor, as directed by the Engineer, at no cost to the City.

One bound copy of the final inspection report shall be submitted to the Engineer. Included in the report shall be a map showing the work area, a wye location report, a television inspection report, and a DVD/CD and all pictures.

Television inspection shall be measured and paid for on the basis of unit price as set forth in the bid. Such unit price payment shall be full compensation for all reports, photographs, and other work related work to complete the closed circuit television monitoring.

Revised 2-1-2009

27.15 Exposure of Pipe or Manholes. The Contractor shall conduct the work at all times in such a manner as will insure no disruption to the normal function of the sanitary sewer collection system. Particular attention shall be paid to the threat of introduction of storm water or other waters to the piping and manholes of the collection system. The Contractor shall take whatever precautions are necessary, such as, but not limited to, installation of plugs in exposed pipes and manholes when work is not in progress or when leaving the work site. The Contractor will be held responsible for damages which may occur to either the collection system or to private property through introduction of storm water or other waters to exposed piping or manholes relating to the construction work.

SECTION 28 - DRAINAGE STRUCTURE CONSTRUCTION

28.01 Concrete Work. The construction of forms, mixing, placing, finishing, and curing of concrete work, as well as the fabrication, placement, protection, and cleaning of reinforcement, shall conform to the applicable parts of Division II, Portland Cement Concrete Pavement.

28.02 Brick Work. All brick shall be wetted before being laid in a 1:2 cement mortar. All joints shall be completely filled with mortar and shall not be less than 1/4 inch and not more than 1/2 inch in thickness. The joints shall be completely filled, smooth and free from surplus mortar on the inside of the walls. Bricks shall be laid radially with every sixth course laid as a stretcher course. Brick shall be plastered with 1/2 inch of mortar over the entire outside surface of wall.

28.03 Precast Manhole Sections. Precast concrete sections for manholes shall be installed with bituminous joint filler.

28.04 Acceptance. Upon completion of a job, all debris and surplus materials shall be removed from the job by the Contractor. The Engineer shall be notified, and shall make an inspection of the work. The City will be notified in writing as to the acceptability of the work.

SECTION 29 - METHOD OF MEASUREMENT AND BASIS OF PAYMENT

29.01 Sewer Pipe in Place. Sewer pipe shall be measured and paid for at the contract unit price per lineal foot for various sizes including excavation and backfill complete in place. Sewer pipe shall be measured for payment after installation of the sewer through all line manholes and through the walls of structures and existing manholes and shall include the portion of all wyes considered as main line sewer. Such payment shall be full compensation for all labor, plant, equipment, and materials necessary for a complete and acceptable project, including removal of all debris and final cleanup of the job.

29.02 Wyes. Wyes shall be paid for at the contract unit price for various size wyes. Measurement for payment shall include that portion of the wye from the barrel of the main line sewer to the end of the wye. A 1" x 4" lumber sufficient in length to reach the ground surface shall be placed vertically at the end of each wye.

29.03 Manholes. Manholes shall be paid for at the contract unit price bid per manhole for a depth of five (5) feet which payment shall include base, stubouts, and ring cover. Additional payment shall be made for manholes more than five (5) feet in depth, measured from flow line to top of cover, at the contract unit price for each vertical foot or fraction thereof in excess of five (5) feet.

29.04 Storm Sewer Inlets. Storm sewer inlets shall be paid for at the contract unit price bid per inlet.

City of Grand Island, NE

DIVISION VI

WATER MAINS

THIS DOCUMENT WAS ORIGINALLY
SEALED AND ISSUED BY RYAN L. SCHMITZ
E-13818, ON MARCH 1, 2022
THIS MEDIA SHOULD NOT BE CONSIDERED
A CERTIFIED DOCUMENT AND SHOULD
BE USED FOR REFERENCE ONLY.

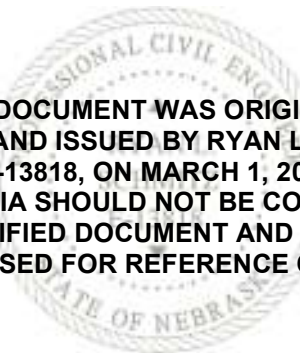

**DIVISION VI
WATER MAINS**

C O N T E N T S

REFERENCES AND DEFINITIONS

| | |
|--------|---|
| ANSI | American National Standards Institute |
| ASME | American Society of Mechanical Engineers |
| ASTM | American Society for Testing Materials |
| AWS | American Welding Society |
| AWWA | American Water Works Association |
| DIPRA | Ductile Iron Pipe Research Association |
| EPA | Environmental Protection Agency |
| NDEQ | Nebraska Department of Environmental Quality |
| DW-NOI | Dewatering Notice of Intent |
| NPDES | National Pollution Discharge Elimination System |
| mg/L | Milligrams per Liter |
| psi | Pounds per Square Inch |
| UNS | Unified Numbering System |
| UHMW | Ultra High Molecular Weight |

| | |
|---------|-------------|
| Section | Description |
|---------|-------------|

30 SCOPE OF WORK

| | |
|-----------|-------------------------------------|
| 31 | MATERIALS |
| 31.00 | Materials |
| 31.01 | Ductile Iron Pipe |
| 31.02 | Fittings |
| 31.03 | Coatings and Linings |
| 31.04 | Gate Valves |
| 31.05 | Butterfly Valves |
| 31.06 | Tapping Sleeves and Tapping Valves |
| 31.07 | Water Main Valves Boxes |
| 31.08 | Swivel Fittings |
| 31.09 | Sleeve Couplings |
| 31.10 | Fire Hydrants |
| 31.11 | Structural Concrete |
| 31.12 | “No-Lead Brass” Fittings and Valves |
| 31.13 | Corporation Stop |
| 31.14 | Curb Stop |
| 31.15 | Water Service Valve Box |
| 31.16 | Copper Pipe |
| 31.17 | Service Saddle |

**DIVISION VI
WATER MAINS**

CONTENTS CONTINUED

| Section | Description |
|-----------|---|
| 31.18 | Full Circle® Repair Clamps |
| 31.19 | Solid Sleeve |
| 31.20 | Restrained Couplings and Glands |
| 31.20.1 | Retainer Glands |
| 31.20.2 | Anchor Couplings |
| 31.20.3 | Ultra-Compact MJ Restraint |
| 31.20.4 | Split-Gland Hydrant Offset Adapter |
| 32 | CONSTRUCTION METHODS |
| 32.00 | Project Supervision |
| 32.01 | Excavation |
| 32.02 | Protection of Existing Utilities |
| 32.02.1 | Excavating Under Existing Water Line |
| 32.03 | Tunneling |
| 32.04 | Pipe Cutting |
| 32.05 | Installation |
| 32.06 | Manholes |
| 32.07 | Service Interruptions |
| 32.07.1 | Connection to City Mains |
| 32.07.2 | Line Stoppers |
| 32.08 | Valve Boxes |
| 32.09 | Pressure and Leakage Tests |
| 32.10 | Sterilization, Flushing, and Sampling of Lines |
| 32.10.1 | Contractor's Expense |
| 32.11 | Tapping of Water Mains |
| 32.12 | Separation from Sanitary Sewer / Storm Sewer Lines (Sewers) / Other Utility Lines and Structures |
| 32.12.1 | Separation from Storm Water Drain-Ways |
| 32.12.2 | Separation from Inlets |
| 32.13 | Backfilling |
| 32.13.1 | Compaction Testing |
| 32.14 | Backfilling Under Pavement |
| 32.15 | Non-shrinkable Backfill |
| 32.16 | Acceptance |
| 32.17 | Water Services |
| 32.17.1 | Service Ownership |
| 32.18 | Water Meter Installations |
| 32.18.1 | Meter Ownership |
| 32.18.2 | Meter Pits and Vaults Prohibited |
| 32.19 | Fire Hydrant |
| 32.19.1 | Fire Hydrant Plumbness |
| 32.20 | Relocation of Mains and Service Lines |

**DIVISION VI
WATER MAINS**

CONTENTS CONTINUED

| Section | Description |
|-----------|---|
| 32.20.1 | Pressure and Leakage Testing of Relocated Mains and Service Lines |
| 32.20.2 | Sterilization, Flushing and Sampling of Relocated Mains and Service Lines |
| 32.20.3 | Water Services on Relocated Mains |
| 32.20.4 | Abandonment of Service Pipes on Relocated Mains |
| 33 | METHOD OF MEASUREMENT AND BASIS OF PAYMENT |
| 33.01 | Water Main |
| 33.02 | Valves and Boxes |
| 33.03 | Hydrants |
| 33.04 | Manholes |
| 33.05 | Fittings |
| 33.06 | Concrete Blocking |
| 33.07 | Corporation Stop |
| 33.08 | Curb Stop |
| 33.09 | Water Services |
| 34 | POLYETHYLENE ENCASEMENT |
| 34.01 | Scope of Work |
| 34.02 | Materials |
| 34.03 | Installation |
| 34.03.1 | Method "A" |
| 34.03.2 | Method "B" |
| 34.03.3 | Method "C" |
| 34.03.4 | Appurtenances |
| 34.03.5 | Repairs |
| 34.03.6 | Openings in Encasement |
| 34.03.7 | Junctions between wrapped and unwrapped pipe |
| 34.03.8 | Backfill for polyethylene pipe |
| 35 | UNDERCROSSING |
| 35.01 | Scope of Work |
| 35.02 | Material |
| 35.03 | Procedure |
| 35.04 | Protection of Public |
| 35.05 | Installation of Casing |
| 35.06 | Removals, Replacements, and Excavation |
| 35.07 | Backfilling |
| 35.08 | Carrier Pipe |
| 35.08.1 | Carrier Pipe - Casing Spacers |

**DIVISION VI
WATER MAINS**

CONTENTS CONTINUED

| Section | Description |
|-----------|--|
| 35.08.2 | Carrier Pipe – Installation |
| 35.08.3 | Carrier Pipe – Casing End Seals |
| 36 | DEWATERING |
| 36.01 | General |
| 36.02 | Discharge Permit |
| 36.03 | Dewatering Wells |
| 37 | TRENCHLESS INSTALLATION OF WATER MAIN |
| 37.01 | General |
| 37.01.1 | Permits |
| 37.01.2 | Site Investigation |
| 37.02 | Materials |
| 37.02.1 | Restrained Joint Pipe |
| 37.02.2 | Pulling Heads |
| 37.02.3 | Polyethylene Encasement |
| 37.03 | Pipe installation |
| 37.03.1 | Drilling System |
| 37.03.2 | Guidance System |
| 37.03.3 | Drilling Fluid System |
| 37.03.3.1 | Drilling Fluid |
| 37.03.4 | Excavations |
| 37.03.5 | Pilot Hole |
| 37.03.6 | Alignment |
| 37.03.7 | Installation – Cartridge Method |
| 37.03.8 | Pull-Back |
| 37.03.9 | Pulling Force |
| 37.03.10 | Backfill and Clean-Up |
| 37.04 | Records and Measurements |
| 37.04.1 | Records |
| 37.04.2 | Measurement for Payment |

DIVISION VI WATER MAINS

This division is written so that ordinarily the type of construction described is complete, but, where applicable, other divisions are considered a part of this specification. All City of Grand Island Standard Plans are to be considered part of this document.

All work to be done must adhere to current AWWA standards or City of Grand Island Division VI specifications whichever is more restrictive.

SECTION 30 - SCOPE OF WORK

The work covered by this division of the specifications consists of furnishing all labor, plant, equipment, appliances, and materials, and performing all operations necessary to construct and complete water mains and appurtenances in strict accordance with these specifications, the applicable drawings, and subject to the terms and conditions of the contract.

SECTION 31 - MATERIALS

31.00 Materials. Materials shall comply with the requirements of the United States of America Safe Drinking Water Act, other federal regulations for potable water systems, and these specifications as applicable. All materials shall be new and unused, and shall conform to the following specifications.

31.01 Ductile Iron Pipe. All pipe shall be ductile iron and shall conform to the AWWA Standard, *DUCTILE-IRON PIPE, CENTRIFUGALLY CAST*, ANSI/AWWA C151/A21.51 and subsequent revisions; and the *THICKNESS DESIGN OF DUCTILE-IRON PIPE*, ANSI/AWWA C150/A21.50 and subsequent revisions or as otherwise shown on the plans.

All pipe three (3) inch diameter to twenty-four (24) inch diameter shall have a nominal length of not less than eighteen (18) feet and be designed for a working pressure of 350 psi with a standard pipe thickness in accordance with Pressure Class 350.

All pipe thirty (30) inch diameter and greater shall have a nominal length of not less than eighteen (18) feet and be designed for a working pressure of 250 psi with a standard pipe thickness in accordance with Pressure Class 250. Mechanical joint pipe, pipe sockets flanges, packing glands, gaskets, and bolts shall conform to the AWWA Standard, *DUCTILE-IRON PRESSURE PIPE AND FITTINGS*, ANSI/AWWA C111/A21.11 and subsequent revisions, and supplied with ductile iron glands as per ASTM A536.

Boltless gasketed joint pipe with the exception of jointing facilities shall conform to the AWWA Standard, *RUBBER-GASKET JOINTS FOR DUCTILE-IRON PRESSURE PIPE AND FITTINGS*, ANSI/AWWA C111/A21.11 and subsequent revisions. Pipe bells shall be grooved or otherwise recessed for gasket sealing and anchorage with reasonably close clearance between pipe bell and adjacent spigot surfaces. The design of the joint shall be such that a deflection of up to three degrees is allowable. All necessary gaskets and gasket lubricants shall be the type recommended and supplied by the pipe manufacturer.

Boltless gasketed joints shall be sealed with a continuous ring gasket manufactured for the use and service and shall seal the joint tight under all operating conditions, including water hammer and pipe movements due to expansion, contraction, and normal settlement. The physical properties and design of the gasket shall be such that they will remain in proper position in the pipe joints under maximum internal pressure and joint deflection conditions. The

composition and physical properties of the gaskets shall be submitted to and approved by the Engineer prior to delivery and installation.

31.02 Fittings. All pipe fittings three (3) inch diameter to twenty-four (24) inch diameter shall be Pressure Class 350 and all pipe fittings thirty (30) inch diameter and greater shall be Pressure Class 250. All fittings shall be ductile iron, mechanical joint, and shall conform to the AWWA Standard, *DUCTILE-IRON AND GRAY-IRON FITTINGS*, ANSI/AWWA C110/A21.10 and subsequent revisions.

Compact ductile-iron, mechanical joint fittings, three (3) inch diameter through twenty-four (24) inch diameter shall conform to the AWWA Standard, *DUCTILE-IRON COMPACT FITTINGS*, ANSI/AWWA C153/A21.53 and subsequent revisions, and designed for a working pressure of 350 psi.

All joint sockets, socket flanges, packing glands, gaskets, and bolts shall conform to the AWWA Standard, *RUBBER-GASKET JOINTS FOR DUCTILE-IRON PRESSURE PIPE AND FITTINGS*, ANSI/AWWA C111/A21.11 and subsequent revisions. Mechanical and push-on joints shall have the same pressure rating as the pipe or fitting of which they are a part. All fittings shall be supplied with ductile iron glands as per ASTM A536 and all required connecting bolts, nuts, glands, gaskets, and accessories.

Unless otherwise specified all bolt holes shall straddle the vertical centerline of all mechanical joint flanges, fittings, valves, and hydrants. (The vertical centerline of a fitting is determined when the fitting is in the position to change the direction of the fluid flowing in a horizontal plane.)

31.03 Coatings and Linings. The interior surfaces of all pipe and fittings shall be cement mortar lined in accordance with ASTM C150 and shall conform to the AWWA Standard, *CEMENT-MORTAR LINING FOR DUCTILE-IRON PIPE AND FITTINGS FOR WATER*, ANSI/AWWA C104/A21.4 and subsequent revisions. All cement mortar lining shall be coated with asphaltic seal coat in conformity with the referenced standard specifications.

The exterior of all pipe fittings and interior surface of bells not cement mortar lined, shall be coated with a bituminous pipe coating of a type acceptable to the Engineer. The coating shall dry to a smooth, glossy surface, shall not be brittle when cold or sticky when exposed to the sun, and shall adhere to the pipe at all temperatures. Coating shall be free from blisters and holidays. Coatings and linings shall conform to all subsequent revisions of the cited specifications.

31.04 Gate Valves. All valves up to and including twelve (12") inch diameter shall be ductile-iron or cast-iron body, resilient wedge gate valves, and shall conform to the AWWA Standard, *RESILIENT-SEATED GATE VALVES FOR WATER SUPPLY SERVICE*, ANSI/AWWA C509 and C515 (ductile iron) subsequent revisions. Valves shall have mechanical joint ends, 2" square operating nut for key operation and "O" ring type stem seals. All valves shall open counterclockwise and be of the non-rising stem type. The valve sealing mechanism shall be a wedge design of ductile-iron or cast-iron, completely encapsulated with a molded resilient covering permanently bonded to the iron wedge to meet ASTM D429 testing. The sealing mechanism shall be designed to provide zero leakage at a minimum of 200 psi operating pressure, with flow in either direction. All valves shall have a full unobstructed waterway, coated with a corrosion resistant material free of cavities or projections conforming to the AWWA Standard, *PROTECTIVE EPOXY INTERIOR COATINGS FOR VALVES AND HYDRANTS*, ANSI/AWWA C550 and subsequent revisions. All valves shall be furnished with all required connecting bolts, nuts, glands, gaskets, and accessories.

Unless otherwise specified, all bolt holes shall straddle the vertical centerline of all mechanical joint flanges, fittings, valves, and hydrants. (The vertical centerline of a fitting is

determined when the fitting is in the position to change the direction of the fluid flowing in a horizontal plane.)

Valves shall be American® Series 2500-1 Resilient Wedge Gate Valve MJ/MJ, Clow Valve Co.® Model 2639, 2640 F-6100 and 2638 F6100, Kennedy Valve® 7571 and 8571, or Mueller Co.® A-2361 and A-2362.

31.04.1 ALPHA™ Valves. Valves shall be AMERICAN Flow Control Series 2500-1 Resilient Wedge Gate Valve with ALPHA™ Restrained Joint Ends designed for use in drinking water systems. The valve shall meet or exceed ANSI/AWWA C515. Valves shall have a rated working pressure of 250 psi. All cast ferrous components of the valve shall be ductile iron. The valve shall be certified to NSF/ANSI Standard 61. Operation by a 2" square wrench nut is required, and valve shall open counterclockwise. The valve inlet shall be designed for use with ductile iron. The inlet shall incorporate stab-fit design requiring the use of one Type 304 stainless steel fastener. The valve inlet shall be the ALPHA™ design furnished by AMERICAN Flow Control.

31.05 Butterfly Valves. All valves, fourteen (14) inch diameter and larger, shall be rubber seated butterfly valves and shall conform to the AWWA Standard, *RUBBER-SEATED BUTTERFLY VALVES 3" In THROUGH 72 In*, ANSI/AWWA C504 and subsequent revisions, with heavy duty cast iron or ductile-iron bodies. The valves shall be designed for a working pressure of 150 psi. Each valve shall have mechanical joint ends, a suitable heavy reliable operator with more than adequate strength for the torque involved, and a 2" square operating nut for key operation. The operators and shafts shall be fully grease-packed and sealed for life and shall be suitable for direct burial. Valves shall be furnished with standard AWWA nuts and stainless steel shafts or high tensile carbon steel. All valves shall be furnished with all required connecting bolts, nuts, glands, gaskets, and accessories and open counterclockwise.

Valves shall be Henry Pratt® Groundhog butterfly valves or Mueller® Lineseal III butterfly valves.

31.06 Tapping Sleeves and Tapping Valves. All tapping sleeves shall be either ductile-iron body, mechanical joint, or 304 stainless steel body, full circumferential seal with carbon steel flange, ductile iron or stainless steel flange. All tapping sleeves shall be furnished with all required connecting bolts, nuts, glands, gaskets, and accessories. Tapping sleeves shall be designed for a working pressure of at least 200 psi.

Ductile iron body tapping sleeves shall be: American® Series 2800-C tapping sleeve; Kennedy Valve® tapping sleeve, or Mueller Co.® H-615 tapping sleeve.

Stainless steel body tapping sleeves shall be manufactured in compliance with AWWA Standard C223; and shall be: Ford Meter Box Co.® "Fast" with carbon steel flange only up to 16"; Romac Industries, Inc® "SST" with ductile flange; Mueller Co.® "H-304" with carbon steel or ductile flange; or Smith Blair ® 662 with carbon steel flange only up to 12".

All tapping valves shall conform to the AWWA Standard, *RESILIENT-SEATED GATE VALVES FOR WATER SUPPLY SERVICE*, ANSI/AWWA C509 and C515 and subsequent revisions. Valves shall have a 2" square operating nut for key operation and "O" ring type stem seals. All valves shall open counterclockwise and be of the non-rising stem type. The valve sealing mechanism shall be a wedge design of ductile-iron or cast-iron, completely encapsulated with a molded resilient covering permanently boned to the iron wedge to meet ASTM D429 testing. The sealing mechanism shall be designed to provide zero leakage at a minimum of 200 psi operating pressure, with flow in either direction. All valves shall have a full unobstructed waterway, coated with a corrosion resistant material free of cavities or projections conforming to the AWWA Standard, *PROTECTIVE INTERIOR COATINGS FOR VALVES AND*

HYDRANTS, ANSI/AWWA C550 and subsequent revisions. All tapping valves must have indexing rings to properly seat against approved tapping sleeves.

Unless otherwise specified, all bolt holes shall straddle the vertical centerline of all mechanical joint flanges, fittings, valves, and hydrants. (The vertical centerline of a fitting is determined when the fitting is in the position to change the direction of the fluid flowing in a horizontal plane.)

Tapping valves shall be: American® Series 2500-1 RW; Kennedy Valve®7950 and 8950, Clow Valve Company Model 2639, 2640 F-6114 and 2638 F-6114 or Mueller Co.® T-2361 and T- 2362.

31.07 Water Main Valve Boxes. All buried valves installed in lines larger than 2” dia., shall be provided with cast iron, “Buffalo” type, valve boxes. Valve boxes shall have a two-piece screw-type extension sleeve and be intended for the size of valve on which it is to be used and for the depth of cover as required. The box’s lid shall have the word “WATER” cast thereon. All valve boxes and valve box components must be Heavy Duty. Valve boxes shall be size 664-S: “Tyler Union – series 6850, SIP Industries – series 601, Star Pipe Products – series VB-0001 or SIGMA VB266X.

Valve box extensions shall be cast iron, screw-type: Tyler Union – series 6850 boxes; SIP Industries – series 6118; or Star Pipe Products – series VBES24S.

31.08 Swivel Fittings. MJ x Swivel fittings shall meet all requirements of section “31.02 Fittings” and shall have prior approval of the Utilities Dept. before installation.

31.09 Sleeve Couplings. Sleeve couplings shall conform to the AWWA Standard, *BOLTED, SLEEVE-TYPE COUPLINGS FOR PLAIN-END PIPE*, ANSI/AWWA C219 and subsequent revisions, and have an inside diameter suitable for connecting ductile iron pipe to ductile iron pipe or cast iron pipe to cast iron pipe. The center sleeve shall be ductile iron ASTM A-536, grade 65-45-12. Ends shall have a smooth inside taper for uniform gasket seating. End rings shall be ductile iron ASTM A-536, grade 65-45-12. Couplings shall be furnished complete with gaskets, bolts, and nuts conforming to the AWWA Standard, *RUBBER-GASKET JOINTS FOR DUCTILE-IRON PRESSURE PIPE AND FITTINGS*, ANSI/AWWA C111/A21.11 and subsequent revisions, and without pipe stops. All materials shall be designed for 250 psi working pressure with the resulting seal flexible and bottle-tight.

Sleeve couplings shall be: Romac Industries, Inc® 501, Smith Blair ® 442, Hymax® 2 Wide-Range, or Romac Alpha, or Romac Macro HP Wide-Range. The center sleeve shall have a minimum Length as determined by the table below:

| | Pipe Diameter | Minimum Sleeve Length Required |
|------------------------|---------------|--------------------------------|
| Romac 501 | 3" to 12" | 7" |
| Romac 501 | > 12" | 14" |
| Smith Blair 442 | 4" to 8" | 7" |
| Smith Blair 442 | > 8" | 14" |
| Hymax 2 | 4" to 12" | 7" |
| Romac Alpha | 4" to 12" | 7" |
| Romac Macro HP | 4" to 12" | 7" |

31.10 Fire Hydrants. Fire hydrants shall conform to the AWWA Standard, *DRY-BARREL FIRE HYDRANTS*, ANSI/AWWA C502 and subsequent revisions. Hydrants shall have a rated working pressure of at least 200 psi. Hydrants shall be manufactured with “O” ring packing, 5-

1/4" valve opening, 6" stand pipe, 6" mechanical joint inlet, two 2-1/2" hose connections (nozzle) with 3-1/16" OD and 7-1/2 threads per inch NST and one 4-1/2" pumper connection (nozzle) with 5-3/4" OD and 4 threads per inch NST. Hydrants shall have a 1-1/2" pentagonal operating and nozzle cap nuts which open left or counterclockwise. Fire hydrant trench depths (equivalent to bury) shall be five (5) foot or five and a half (5.5) foot.

Fire hydrants shall be furnished with all the required connecting bolts, nuts, glands, and gaskets. Unless otherwise specified, all bolt holes shall straddle the vertical centerline of all mechanical joint flanges, fittings, valves, and hydrants. (The vertical centerline of a fitting is determined when the fitting is in the position to change the direction of the fluid flowing in a horizontal plane).

Fire hydrants shall be factory painted as per City requirements with an industrial enamel exterior grade paint. Public fire hydrants and City maintained private hydrants shall be painted to have yellow barrels with red caps and bonnet; private fire hydrants shall be painted solid red. Colors shall be Guardsman Yellow #760-4004-00 and Red #760-7008-00, or Sherwin Williams Yellow #F77Y9 and Red #77R7, or Glidden Yellow #4540 and Red #4520.

Hydrants shall be: American-Darling B-84-B-5; Kennedy Guardian K-81D; or Mueller Super Centurion A-423 3-way.

31.10.1 ALPHA™ Fire Hydrants. All hydrant inlets shall be the ALPHA™ design furnished by AMERICAN Flow Control. The inlet shall incorporate stab-fit design requiring the use of only one Type 304 stainless steel fastener. The assembly of flange or mechanical joint restrainers using multiple fasteners or wedge bolts is not permitted. Restraint accessories shall be factory installed.

Hydrants shall be the AMERICAN Flow Control American-Darling 5-1/4" B-84-B-5 with ALPHA base.

31.11 Structural Concrete and Pavement. All concrete shall be type 47-B (modified) air-entrained as specified in City of Grand Island Specifications, Division II, "PORTLAND CEMENT CONCRETE PAVEMENT" or 47B-HE-3500 (high early) as specified in the latest revision of the Nebraska Department of Transportation Standard Specifications for Highway Construction Finish can be either broomed or burlapped. All structural concrete shall have a minimum of 24 hours of cure time before any pressure is applied to the water system.

When average daily temperatures are below 40°F (4.5°C) for more than three consecutive days, the Contractor shall use approved practices and procedures that will assure that placed concrete will be sufficiently strong and durable to fully meet design requirements. The use of insulating coverings, accelerating admixtures, high-early strength cement, or additional cement may be used to develop the level of strength required. All such methods shall fully conform to the American Concrete Institute's Guide to Cold Weather Concreting (ACI 306R-16). There shall be no additional payment if such cold weather techniques are required.

31.12 "No-Lead Brass" Fittings and Valves. This specification shall apply to any waterworks brass goods, such as corporation stops, curb stops, coupling, connectors, nipples, etc. All such goods shall comply with the United States Of America Safe Drinking Water Act, and the U.S. Environmental Protection Agency.

The brass part of any fitting or valve in contact with potable water shall be made of a "No-Lead Brass", and shall conform to UNS Copper Alloy No. C89520 or C89833 in accordance with the chemical and mechanical requirements of ASTM B584 and AWWA Standard, UNDERGROUND SERVICE LINE VALVES AND FITTINGS, ANSI/AWWA C800 with a maximum lead content of 0.25% by weight.

All brass fittings and valves shall have the manufacturers name or trademark permanently stamped or cast on it. Additional marking such as "NL", "EBII", "FD" or other

commonly accepted identifier, indicating the alloy as “No-lead” shall also be cast or stamped into the fitting or valve.

31.13 Corporation Stop. All corporation stops $\frac{3}{4}$ ”, 1”, 1-1/2”, or 2” in size, shall be Ford Meter Box Co.® FB1000-NL ball valve; A.Y. McDonald Co.® 74701B-22 ball valve; or Mueller Co.® 300-N ball valve.

31.14 Curb Stop. All curb stops $\frac{3}{4}$ ”, 1”, 1-1/2”, or 2” in size, shall be Ford Meter Box Co.® B44-NL ball valve; A.Y. McDonald Co.® 76100-22 ball valve; or Mueller Co.® 300-N ball valve.

31.15 Water Service Valve Box. Curb stops in service lines 2” dia. or smaller, shall be provided with cast iron, two-piece screw-type, size 94-E valve boxes. The box’s lid shall have the word “WATER” cast thereon and supplied with a standard pentagon head brass screw.

An enlarged base shall be used with a complete service box for all 1-1/2” and 2” curb stops.

Service boxes shall be: Tyler Union – 6500 series; SIP Industries – series 6359; or Star Pipe Products – series SB-0001=

31.16 Copper Pipe. All water service lines $\frac{3}{4}$ ”, 1”, 1-1/2”, or 2” in size, shall be flexible Type “K” soft copper pipe.

31.17 Service Saddle. All service saddles shall conform to the AWWA Standard, *UNDERGROUND SERVICE LINE VALVES AND FITTINGS*, ANSI/AWWA C800 and subsequent revisions, and as additionally specified herein.

The saddle body shall be, high strength ductile-iron per ASTM A536, hot dipped zinc galvanized, enamel, or epoxy coated, with outlet tapped for CC taper threads, and a steel double strap design for use on cast iron or ductile-iron pipe. A service saddle shall be required for 1-1/2” and larger service taps on all mains regardless of thickness class.

All service saddles shall be Ford Meter Box Co.® F202; Mueller Co.® DR2A; Romac Industries, Inc.® 202NS; A.Y. McDonald Co.® 4825A; or Smith-Blair 317.

31.18 Full Circle® Repair Clamps. Full Circle® Repair Clamps in size 4” and 6” with a standard width of 12.5” shall be used to repair leaks due to complete breaks, splits or holes when required and approved by the Utilities Department. Full Circle® Repair Clamps shall have a rated working pressure of at least 200 psi. The repair clamp band shall be type 304 stainless steel.

Full Circle® Repair clamps shall be Smith-Blair Model 226; or FORD FS1 (up to 10”), FS2, and FS3.

31.19 Solid Sleeve. Compact ductile-iron sleeves, three (3) inch through forty-eight (48) inches shall conform to the AWWA Standard, *DUCTILE-IRON COMPACT FITTINGS*, ANSI/AWWA C153/A21.53 and subsequent revisions.

All sleeves three (3) inches to twenty-four (24) inches shall be designed for a working pressure of 350. All pipe thirty (30) inches and greater shall be designed for a working pressure of 250. The center sleeve shall have a minimum of a twelve inch (12”) wide body and be furnished complete with gaskets, bolts, and nuts.

31.20 Restrained Couplings and Glands. With prior approval from the Utilities Department, mechanical joint restraint couplings and glands may be used on fittings, valves, and pipe in lieu of concrete thrust blocks; however, thrust blocks will be required where indicated on plans.

31.20.1 Retainer Glands. All retainer glands shall be ductile iron conforming to ASTM A536 and designed for a working pressure rating of 350 psi. Glands shall have a wedge style design and torque limiting bolts to fully restrain the fitting and pipe together.

Retainer glands shall be “EBAA Iron, Inc. – Megalug series 1100”, “Romac Industries, Inc. – RomaGrip”, “Star Pipe Products – series 3000”; “Tyler Union – TufGrip series 1000” or “SIP Industries – EZ Grip”.

31.20.2 Anchor Couplings. Anchoring couplings shall be a ductile iron fitting, which provides a restrained connection without the use of braces or blocking and designed to prevent the joint from separating under pressure when all bolts are in place. It shall have a pressure rating of 350 psi; be equipped with freely moving, 360° rotatable couplings conforming to ASTM A536; and manufactured to fit standard mechanical joint connections.

31.20.3 Ultra-Compact MJ Restraint. The connector shall be an ultra-compact, bolt-through mechanical joint restraint, for 4”, 6”, and 8” valves and fittings, manufactured of ductile iron, cement-lined inside, asphalt-coated for corrosion protection, and conform to AWWA Standards, ANSI/AWWA C153/A21.53 and ANSI/AWWA C104/A21.4 and have a working pressure rating of 350 psi.

The bolt-through, positive restraint device shall connect valves and fittings at a linear distance not to exceed one (1) inch and without attachment to the pipe; (the device shall not be used directly on fire hydrant shoes).

Connector shall be furnished complete with all gaskets and bolts, and be “Infact Corporation, Foster Adaptor”..

31.20.4 Split-Gland Hydrant Offset Adapter. Offset adapters shall be manufactured of ductile iron, cement-lined inside and asphalt-coated for corrosion protection and conform to AWWA Standards: ANSI/AWWA C153/A21.53 and ANSI/AWWA C104/A21.4 and have a pressure rating of 350 psi. The adapter shall provide a restrained joint and alignment adjustment in a single fitting, allowing fire hydrants to be set to grade without extension kits. Adapters shall come complete with all gaskets, bolts, and rotatable split-retainer glands.

Split-Gland hydrant offset adapters shall be: Assured Flow Sales, Inc. – Gradelok.

SECTION 32 – CONSTRUCTION METHODS

32.00 Project Supervision. The general contractor shall be required at all times during construction activities to have a designated Project Supervisor at the work site.

The *Project Supervisor* shall be experienced in all aspects of the project and will be responsible for on-site, day-to-day management of the project.

The Project Supervisor shall have:

- Practical written and verbal communication skills of the English language.
- Ability to read, understand, and accurately interpret the contract documents, plans, specifications, and survey stakes prepared for the project.
- Skilled knowledge of construction techniques.
- Ability to supervise the entire construction crew, including sub-contractors.
- The experience and ability to identify existing and predictable hazards in the surroundings or working conditions, and the authority to take prompt corrective measure to resolve problems and / or eliminate them.
- A set of contract documents, plans and specifications at the work site.

If the Contractor’s *Project Supervisor* is not at the work site, the Utilities Dept. representative shall notify the Contractor and all construction activities shall cease until such

time as a qualified replacement arrives on site. No claims for financial adjustment due to inadequate project supervision shall be permitted by the City.

32.01 Removals, Replacements and Excavation. Concrete removals shall be done by saw cut on existing joints or as directed by Utilities Department representative and Streets Dept. Sealing of joints on replaced concrete shall be with tar; a cold-apply sealant from the Nebraska DOT approved products list may be used when conditions with approval from Utilities Dept. representative and Public Works approval. The Contractor shall perform all excavation of whatever substances encountered to the depth shown on the drawings or to provide a minimum cover of five (5) feet over the top of the pipe. Depth shown on drawings shall take precedence over minimum cover. The Engineer shall have the right to limit the amount of trench that may be opened in advance of the line of work.

All excavated materials not required for backfill shall be removed from the project by the Contractor. Banks of trenches shall be kept as nearly vertical as practicable and, where required, shall be properly sheeted, braced, benched or sloped. Trenches shall be of sufficient width to provide working space for proper installation.

The bottom of the trenches shall be accurately graded to provide uniform bearing and support for each section of pipe on undisturbed soil at every point along its entire length, except for portions of the pipe sections where it is necessary to excavate for bell holes.

Whenever wet or unstable soil that is incapable of properly supporting the pipe, as determined by the Engineer, is encountered in the trench bottom, such soil shall be removed to the depth and length determined by the Engineer and the trench backfilled to grade with sand, gravel, or other suitable material.

All grading in the vicinity of trench excavation shall be controlled to prevent surface water from flowing into the trench. Any water accumulating in the trench shall be removed by pumping or other approved method. Material excavated from the trenches shall be stacked in an orderly manner a sufficient distance back from edge of trenches to avoid overloading and preventing slides or cave-ins. Materials unsuitable for backfilling shall be wasted by the Contractor as directed by the Engineer. Any unauthorized excavation below grade shall be backfilled at the Contractor's expense with good, well-tamped material.

A minimum of one foot of topsoil (unless otherwise noted on the plans) shall be removed in any and all areas covered by vegetation. This topsoil shall be stockpiled separately from the material removed from the remainder of the trench. After the pipe is installed and the trench backfilled to an elevation one foot (unless otherwise noted on the plans) below grade, the topsoil shall be replaced and compacted as previously described.

Excavation will not be classified. Whatever material is encountered shall be excavated to the proper grades and, if in any locations such material is not sufficient to provide a uniform even bed for the pipe, the trench shall be excavated at least three (3) inches deeper than the grade at the bottom of the pipe and the space thus excavated shall be refilled with earth or sand and thoroughly compacted.

32.02 Protection of Existing Utilities. The accuracy of location of existing underground utilities as shown on the plans is not guaranteed. It shall be the duty of the Contractor to locate these utilities in advance of excavation and to protect same from damage after uncovering. The Contractor shall contact the owners of the utilities for assistance in locating these service lines. Any expense incurred by reason of damaged or broken lines shall be the responsibility of the Contractor.

Freeze protection is required for all excavated water lines exposed to the elements when temperatures are below 32°F (0°C). There shall be no additional payment if freeze protection is required.

32.02.1 Excavating Under Existing Water Line. When crossing under an existing water line, in order to install sanitary sewer or other utilities, a pipe support detail must be provided. Contractor to submit detail for support of water main when required for working under existing water mains to Utilities Department for review and approval at least three (3) weeks prior to any work occurring.

32.03 Tunneling. Tunneling, when necessary, shall be done under the supervision of the Engineer. Refer to Section 35 – UNDERCROSSING.

32.04 Pipe Cutting. Cutting of the pipe shall be kept to a minimum and shall be done in a neat and workmanlike manner without damage to the pipe. Unless otherwise authorized by the Engineer, cutting shall be done by means of an approved type of mechanical cutter. Wheel cutters shall be used when practicable. Cut pipes between mechanical joint fittings, “nipples”, shall be no less than 18” in length. Cut pipe with either bell or spigot ends shall be no less than 48” in length.

32.05 Installation. Pipe and accessories shall be handled in such manner as to insure delivery to the work in a sound, undamaged condition.

While suspended in a sling and before lowering into the trench, all pipe shall be inspected for defects. Defective, damaged, or unsound pipe will be rejected. Deflections from a straight line or grade, as required by vertical or horizontal curves, shall not exceed manufacturer’s recommendations and approval by Engineer.

Mechanical joints shall be installed under the provisions of the recommendations of the joint manufacturer. Fittings at bends or deadends shall be firmly blocked against the vertical face of the trench to prevent fittings from being blown off the lines when under pressure. Blocking shall conform to the plan for concrete blocking for fittings. Where pipe ends are left for future connections, they shall be valved, plugged, or capped as shown on the plans. Where connections are made between new work and existing mains, the connections shall be made by using fittings as required.

Hydrant extensions, tees, valves, plugs and caps may be installed by the Contractor under the supervision of a Utilities Department representative.

32.06 Manholes. Manholes shall be constructed as indicated on Standard Plan Drawings, No. 135 or 136, or as otherwise shown on the plans. Floors of the manholes shall be earth. Manholes over three (3) feet in depth shall be equipped with cast iron steps placed on approximately sixteen (16) inch centers.

32.07 Service Interruptions. When it becomes necessary for the purpose of making connections or for any other reason to shut off or turn on water in any existing mains, it is the sole responsibility of the Contractor to notify the City Water Department through the resident Engineer a minimum of 24 hours in advance as to when and for how long service will be interrupted and also to notify all water users a minimum of 12 hours in advance so they might prepare themselves for the period during which service might be interrupted. Critical users, as determined by the City of Grand Island, may require more notice. Valves shall not be opened or closed by anyone other than City Water Department personnel.

32.07.1 Connection to City Mains. Newly installed piping shall not be placed in service until acceptance of all pressure and bacteria tests, unless otherwise noted on the plans. Test plugs, corporations, connecting sleeves, dewatering, and temporary piping to a water source, shall be furnished and installed by the Contractor.

The Utilities Department reserves the right to inspect the installation of all private water lines three-inch (3") diameter and larger. Contractor must notify Utilities Engineering Division at least 48 hours in advance of installing and pipe, fittings, or appurtenances.

32.07.2 Line Stoppers. When necessary to isolate sections of water lines for maintenance, repairs, lowering, or for other reasons when service interruptions in an existing main are not allowed, line-stoppers shall be used to eliminate system shut-down.

Line-stoppers shall be defined as a complete modular system of equipment specifically designed for plugging water lines in order to temporarily stop the flow of water as may be required for repair, replacement, and / or relocation of water main components. The flow control device shall be inserted at normal water main pressure.

Line-stoppers, inserted into mains twelve-inch (12") dia. or smaller, shall be furnished and installed by the Grand Island Water Department. The actual material expense and labor costs associated with the use of such line-stoppers shall be charged to the Contractor.

In water lines larger than twelve-inch (12") dia., the Contractor shall make arrangements for line-stoppers to be furnished and installed by a firm specializing in their use, with extensive experience in their equipment's operation. Prior to installation, all devices shall be thoroughly checked, cleaned, and sanitized by the Contractor. The City's Water Department shall inspect all equipment and issue final approval before installation of line-stoppers.

The Contractor shall be responsible for all excavations and properly maintaining trench banks, sheeting, and bracing as required. Trenches shall be of sufficient width to provide proper working space. After the work is completed, the Contractor shall backfill the trench with suitable compacted materials as specified.

32.07.3 12" and Larger Water Main Outage. Water mains 12" and larger in size shall not be taken out of service for construction or relocation from May 1st to September 30th. Any outage of shall be at the discretion of the Utilities Department.

32.08 Valve Boxes. Valves and valve boxes shall be installed in the lines as shown on the drawings and as directed by the Engineer. They shall be set plumb and centered with valve boxes placed directly over the valves. Earth fill shall be carefully tamped around all valve boxes. Valve boxes shall have the interiors cleaned of all foreign matter before installation.

32.09 Newly Installed Water Piping System Testing Requirements. All newly installed water piping systems three-inch (3") dia. and larger, shall be subject to the following testing requirements:

1) Water mains less than twenty (20) feet in length shall be visually inspected and flushed upon completion. All work must be done under the direct supervision of the Utilities Dept.

2) Water piping systems less than one hundred (100) feet but greater than twenty (20) feet in length shall be hydrostatically pressure tested, disinfected, flushed and sampled for bacteriological analysis. Only one set of bacteriological samples will be collected from the downstream end of line.

3) Water piping systems greater than one hundred (100) feet in length shall be hydrostatically pressure tested, disinfected, flushed and sampled for bacteriological analysis. At least one set of samples shall be collected from each end of line. Samples shall also be collected from every 1,200 feet the new water main, and one set from the end of each branch section, twenty (20) feet or more in length.

4) All private water service piping systems, regardless of length, shall be hydrostatically pressure tested, disinfected, flushed, and sampled for bacteriological analysis without exception.

Test tap locations shall be installed at the direction of the Utilities Department. The testing of all water piping systems shall be under the discretion of the Utilities Department. Direct supervision shall be defined as a Utilities Department Representative on site for the duration of the work.

32.09.1 Hydrostatic Pressure Test. The Contractor shall furnish all labor, pumps, pipe connections, line plugs, adapters, caps, and all other necessary apparatus, except gauges, for performing hydrostatic pressure and leakage tests in accordance with AWWA Standard, *INSTALLATION OF DUCTILE-IRON WATER MAINS AND THEIR APPURTENANCES*, ANSI/AWWA C600, except as otherwise specified. The City will furnish calibrated gauges for the tests and a source of water.

After distribution pipe has been laid, all new potable water systems, three-inch (3") dia. and larger, and each valved section thereof, shall be subjected to a hydrostatic pressure of at least one and one half (1-1/2) times the working pressure (100 PSI minimum) at the point of testing. All privately owned lines, three-inch (3") dia. and larger, shall be subjected to a hydrostatic pressure of at least 200 psi.

Each valved section of pipe shall be slowly filled with water, and the specified test pressure shall be applied by means of a pump connected to the pipe in a manner satisfactory to the Engineer. Valves shall not be operated in either the opening or closing direction at differential pressures above the rated pressure. When hydrants are in the test section, the pressure test shall be made against closed hydrant valves.

Before applying the specified test pressure, air shall be expelled completely from the pipe, valves, and hydrants. If permanent air vents are not located at all high points, corporation cocks shall be installed at such points so the air can be expelled as the line is filled with water. After all the air has been expelled, the corporation cocks shall be closed, and the test pressure applied. At the conclusion of the pressure test, the corporation cocks shall be removed and plugged by the Contractor.

When the specified pressure has been reached, the valve between the pump and the pipeline shall be closed, and the pump shall be disconnected and removed. The test pressure shall remain for a minimum of two (2) hours. If the pressure varies more than two pounds per square inch plus or minus (2 PSI+/-) during the duration of the test, it shall be extended for twenty-four (24) hours to satisfy those concerned that the decrease in the pressure is not due to thermal-volume changes of the water in the line. At the end of the twenty-four (24) hour period, the pressure shall be brought back up to the specified pressure and observed for two (2) hours.

During the pressure test, any exposed pipe, fittings, valves, hydrants, and joints shall be examined carefully. Any damaged or defective pipe, fittings, valves, hydrants, or joints that are discovered shall be repaired or replaced with sound material, and the test shall be repeated until it is satisfactory to the Owner.

32.09.2 Sterilization, Flushing and Sampling of Lines. All new potable water systems, three-inch (3") dia. and larger and each valved section thereof, shall be disinfected before they are placed in service. All water mains taken out of service for inspecting, repairing, or other activity that might lead to contamination of water shall be disinfected before they are returned to service. The Contractor shall furnish all labor, pumps, pipe connections, additional line plugs, adapters, caps, and all other necessary apparatus and materials. All work shall conform to the AWWA Standard, *DISINFECTING WATER MAINS*, ANSI/AWWA C651 and subsequent revisions, except as otherwise specified.

Precautions shall be taken to protect the interiors of pipes, fittings, and valves against contamination. All materials delivered for construction shall be stored so as to minimize entrance of foreign material. All openings in the pipeline shall be closed with watertight plugs when pipe laying is stopped at the close of the day's work or for other reasons, such as rest breaks or meal periods.

Immediately prior to installing any pipe or fittings, the Contractor shall swab the interior of the pipe or fittings with a minimum 2% hypochlorite disinfecting solution.

After acceptance of the pressure and leakage test, the main shall be filled with water at a rate such that water within the main will flow at a velocity no greater than one (1) foot per second. Precautions shall be taken to assure that air pockets are eliminated. When all air has been eliminated, the main shall be flushed to remove particulates. The flushing velocity in the main shall not be less than three (3) feet per second for distribution mains and domestic services and ten (10) feet per second for fire service lines, unless the City determines that conditions do not permit the required flow to be discharged to waste. The main isolation valve shall not be operated for flushing or re-chlorination until a downstream hydrant is opened. During such operations, the main isolation valve shall only be operated by Utility Department personnel.

After the initial flushing operation, the main shall be disinfected by chlorination. Chlorination will commence at a point not more than ten feet (10') downstream from the beginning of the new main. Water from an approved supply source, shall be made to flow at a constant and measured rate into the newly laid water main, and shall receive a dose of chlorine, fed at a constant rate such that the water will have not less than twenty-five (25) mg/L free chlorine. The chlorine shall be applied to the water main by injecting a hypochlorite solution by means of a chemical-feed pump designed for feeding chlorine solutions.

Feed lines shall be of such material and strength as to safely withstand the corrosion caused by the concentrated chlorine solutions and the maximum pressures that may be created by the pumps. All connections shall be checked for tightness before the solution is applied to the main. During the application of chlorine, valves shall be positioned so the strong chlorine solution in the main being treated will not flow into water mains in active service. Chlorine application shall not cease until the entire main is filled with heavily chlorinated water.

The chlorinated water shall be retained in the main for at least twenty-four (24) hours and a maximum ninety-six (96) hours, during which time all valves and hydrants in the treated section shall be operated to ensure disinfection of the appurtenances. At the end of this retention period, the treated water in all portions of the main shall have a residual of not less than ten (10) mg/L free chlorine. After the applicable retention period, the heavily chlorinated water shall be flushed from the main until chlorine measurements show that the concentration in the water leaving the main is no higher than five-tenths (0.5) mg/L or as prevailing in the system.

The Contractor shall provide a means of disposing of the water and sterilizer so as to prevent damage to the environment during flushing operations. If there is any question that the chlorinated discharge will cause damage to the environment, then the Contractor shall supply a reducing agent to the water to be wasted to neutralize thoroughly the chlorine residual remaining in the water. Where necessary, Federal, State and local regulatory agencies shall be contacted to determine special provisions for the disposal of heavily chlorinated water.

After final flushing and before new water main is connected to the main system, two consecutive sets of acceptable samples, taken at least twenty-four (24) hours apart, shall be collected from the new main. A set of samples shall be defined as two (2) samples taken twenty-four (24) hours apart at each test tap location.

Samples shall show the absence of coliform bacteria, per Nebraska DHHS requirements, to pass. Following successful sampling and testing of the line, the Contractor

shall remove all testing apparatus and plug the main at the point of injection of the disinfectant and flushing discharge.

Samples for bacteriological analysis shall be collected in sterile bottles treated with sodium thiosulfate as required by "Standard Methods for the Examination of Water and Wastewater." No hose or fire hydrant shall be used in collection of samples. Sample tubing shall be a maximum of one-inch (1") dia. and devices shall be clean and disinfected with isopropyl rubbing alcohol or a 2% chlorine solution and flushed prior to sampling. Sterilization by flame is not permitted. The Utility Department shall collect the final certification samples of record to check for complete disinfection. If the initial disinfection fails to produce satisfactory bacteriological samples, the main shall be re-chlorinated in accordance with this section until satisfactory results are obtained.

The Contractor shall have the opportunity to perform the actual chlorination using the Contractor's own personnel and equipment. The Contractor shall notify the Utility Engineering Division in writing at least 48 hours in advance of any work to disinfect the main. If the Contractor's personnel or equipment do not demonstrate the capabilities or methodology to properly disinfect the newly installed main they shall immediately suspend all such work upon written notification from the Utility Department. The disinfection will then be performed by the City and the expense charged to the Contractor.

32.10 Contractor's Expense for Testing. Flushing, disinfection, testing and sampling will be repeated at the Contractor's expense until tests conducted by the Grand Island Utilities Department indicate the pipeline is certified for acceptance into the City's water system.

The rate charged by the City for each chlorination application will be \$0.28 per linear feet of pipeline.

The rate charged by the City for each two-day round of certification samples will be five hundred dollars (\$550.00).

The City will furnish personnel, pumps, and chemicals for the actual chlorination. All temporary discharge hoses, dewatering, piping, excavations, sample taps and corporations, other personnel or equipment, necessary for doing the work will remain the contractor's responsibility.

32.11 Tapping of Water Mains. The Contractor shall furnish the necessary excavation, shoring, tapping valve, tapping sleeve, dewatering, and/or specials, and do all work necessary to make the connection to the water main without interruption of service on the tapped line per Standard Plan 137. The actual tapping of the main will be performed by City personnel and the expense charged to the Contractor unless otherwise noted on the plans. The City is capable of making the following size taps: ¾", 1", 1 ½", 2", 4", 6", 8", 10", 12", 14", 16", 18" and 20".

32.12 Separation from Sanitary Sewer / Storm Sewer Lines (Sewers) / Other Utility Lines and Structures.

There shall be a minimum of eighteen (18) inches vertical clearance between water lines crossing either above or below sewers. Distances shall be measured from outside of water line to outside of sewer lines. Variance requests to this rule must be in compliance with Nebraska DHHS guidance document entitled "Design and Installation Guide for Water Main and Sanitary/Storm Sewer Separations" and City of Grand island Standard Plan 138.

For situations where water lines are parallel to sewer lines, water lines shall be installed at least ten (10) feet horizontally from any existing or proposed sewer line. Distances shall be measured from outside of water line to outside of sewer facilities. Variance requests to this rule must be in compliance with Nebraska DHHS guidance document entitled "Design and Installation Guide for Water Main and Sanitary/Storm Sewer Separations."

For situations where water lines are parallel to other utility lines (gas, electric, water, etc.), water lines shall be installed at least three (3) feet horizontally for parallel installations and one (1) foot vertically at crossings from any existing or proposed utility line. Distances shall be measured from the outside of the water line to outside of other utility line.

Public water mains shall be located a minimum of ten (10) feet horizontally from any structure or foundation. Distances shall be measured from the outside of the water line to the outer face of structure or foundation.

Any variances require a justification letter from the project engineer submitted to the Utilities Engineering Division.

Press-Seal EZ-Wrap has been approved for use as an equivalent to concrete collars when situations allow.

32.12.1 Separation from Storm Water Drain-Ways. Water lines crossing open storm water drain-ways or other surface water crossings shall be adequately supported and anchored; and accessible for repair or replacement. Pipe shall be of special construction, having flexible, restrained, watertight joints.

The water main shall be installed with sufficient earth cover to protect the line from damage due to: freezing; flow characteristics within the channel; depth of scour from flooding; and future channel widening and deepening.

When crossing waterways in excess of fifteen (15) feet in width, valves shall be provided at both ends of the crossing so that the section can be isolated for testing or repair. The valves shall be easily accessible and located so as to not be subject to flooding.

32.12.2 Separation from Inlets

Any inlet with less than four (4) feet of horizontal clearance and less than eighteen (18) inches but greater than six (6) inches of vertical clearance from a water line shall have the following waterproofing measures:

- 1) All construction joints and cold joints between storm pipe and box, between the inlet base and sidewall, must have a Tremco Superstop Waterstop, Cetco Waterstop RX or an approved equal, installed per manufacturer recommendations. When the bottom of the lateral storm sewer pipe is greater than 6" off the bottom of the inlet, waterstop will not be required for the lateral.
- 2) Inlet interior must be coated with a Krystol T1 & T2 Waterproofing System, Xypex Concentrate & Modified System, BASF Masterseal 581 or an approved equal, installed per manufacturer recommendations.

Inlet seals and coatings are to be verified by a Utilities Dept. representative at each step of the process. Inlets shall not be coated until seals have been approved by the Utilities Dept. representative and additional coats shall not be applied without prior approval from Utilities Dept. representative. The Utilities Dept. representative will also give final acceptance of waterproofing measures.

32.13 Backfilling. Trenches shall not be backfilled until all required tests are performed, location has been documented by the Utilities Dept. and until the water system installed conforms to the requirements of the plans and specifications.

Materials for tamped backfill and the method of placement shall be as specified per ANSI/AWWA C600 Type 2 pipe bedding. The trenches shall then be carefully backfilled up to one foot above the top of the pipe with sand or fine earth, in layers of not more than six (6) inches thick and carefully tamped to form a solid bedding for the pipe.

The balance of the excavated material shall be consolidated in the following manner. Tamped backfill will be required for the full depth of the trench above the pipe bedding in layers not to exceed twelve (12) inches in depth. As backfilling proceeds, the entire mass shall be

vibrated with a mechanical vibrator, provided, however, in all locations where plastic soils are encountered, the backfill material shall not be placed until the moisture content is low enough to obtain maximum density when tamped into place with mechanical tampers.

32.13.1 Compaction Testing. When standard backfill methods are used, density tests will be required for each twelve (12) inch vertical lift of compacted material placed at a frequency of not greater than three hundred (300) lineal feet of trench. Density testing shall be required on each trench crossing a public right-of-way or easement. Test locations, to verify trench backfill integrity and methodology, may be specified by the City as required. The Contractor shall maintain the trench backfill for one (1) year from the date of acceptance of the project by the City.

The Contractor shall be required to hire an independent soil testing laboratory to test separately each lift for density and certify that each and every lift was compacted to 95% of maximum density within the public right-of-way and to 90% of maximum density within public easements. Density test results shall be submitted to the City before acceptance of the project by the City.

32.14 Backfilling Under Pavement. All soil backfill under existing sidewalks, curb, gutter, paved street, must be compacted to 95% of maximum density.

32.15 Non-shrinkable Backfill. Use of non-shrinkable backfill may be required or may be requested for substitution of standard backfill methods by the Contractor under all street sections, existing or proposed, with the approval of the City. The backfill shall be filled to the subgrade of the undisturbed sidewalk, curb, gutter, paving, or earth surface. There should also be a 1' buffer of soil, compacted to 95% of maximum density, between the pipe and non-shrinkable backfill.

The non-shrinkable backfill shall be a mixture of sand, gravel, Portland cement, flyash and water (Per the State of Nebraska Department of Roads Standard Specifications for Highway Construction, Section 1003.02) which flows easily around the utility being covered and develops a 28-day compressive strength of from 85 to 175 psi. No non-shrinkable backfill mix designs shall be used without the approval of the Public Works Director.

The mix design shall meet the following requirements:

| | |
|--------------------|-------------|
| Portland Cement | 50 lb/cy |
| 47-B Sand - Gravel | 2,700 lb/cy |
| Water | 420 lb/cy |
| Air | 10% |
| Fly Ash | 200 lb/cy |

32.16 Acceptance. Upon completion of a job, all debris and surplus material shall be removed from the job by the Contractor. The Engineer shall be notified so that an inspection of the work can be made.

32.17 Water Services. Water services shall be installed as indicated on the construction plans. The City Water Department will tap the water main and install the corporation stop. The Contractor shall furnish the corporation stop, dewater the trench, and pay the City Water Department for making the tap unless otherwise noted on the plans. The Contractor shall clearly mark the tap location on the exterior of the water main (not polywrap) with a xylene free, HAPS free, non-toxic paint marker or clay-based lumber crayon prior to the scheduling of water service taps. Service lines shall be buried a minimum of five (5) feet in depth from future finished grade. No splices, joints, or unions in copper water service lines will be allowed

between the water main and the curb stop if the total service length is less than 100 L.F. The service shall extend perpendicularly (90°) from the main's horizontal alignment to the curb stop or service valve location.

All water facilities shall be filled, pressure tested, disinfected, flushed, and acceptable water sample test results obtained, prior to being placed in service.

Following installation of water service lines, the Contractor shall furnish and install a seven (7) foot long, steel studded "T" post, adjacent to each stop box to identify its location. Posts shall be new, painted dark blue in color, and set three (3) feet into the ground. All marking posts shall be incidental to the service line and not a claim for extra material or work.

All work shall be per AWWA standard, *UNDERGROUND SERVICE LINE VALVES AND FITTINGS*, ANSI/AWWA C800 and subsequent revisions, City specifications, and Standard Plan 152.

32.17.1 Service Ownership. Water is conveyed from mains owned by the City of Grand Island to the consumer's premises by service lines and their appurtenances. The service line, pipes, valves, fittings and appurtenances, including the meter, through which a consumer receives water shall be owned by, installed, and maintained at the expense of the consumer.

The dividing point between the City Of Grand Island owned mains and consumer owned service line shall be defined as the connection on the discharge side of the City Of Grand Island owned main. At the dividing point, water irrevocably leaves the public system and enters privately owned facilities to serve the consumer premises.

The maintenance and protection of privately owned piping, service pipes, fittings, meters, fixtures, and water using appliances, is the exclusive responsibility and expense of the consumer; including but not limited to, protection of water using devise by reason of temporary or permanent pressure changes; the stoppage of the flow of water; limited or sustained water pressure; or from dirt or debris that may enter the service connection.

32.18 Water Meter Installations. Meters shall be installed in a clean pipeline, free from foreign materials. The meter shall be installed horizontally with the register facing upward; with the direction of flow as indicated by the arrow cast in the meter case; and protected from freezing, damage, and tampering.

Meters shall be equipped with a strainer, and shall be installed with a minimum of five (5) pipe diameters of straight run of pipe or equivalent full open components, upstream of the meter-strainer inlet flange; two and one-half (2.5) pipe diameters of straight run of pipe or equivalent full open components, downstream of the meter outlet flange. Full open components may consist of: straight pipe, full open gate valves and ball valves, tees, and concentric reducers.

No elbows, bends, non-concentric reducers, check valves, butterfly valves, back flow preventers and/or pressure reducing devices shall be installed within five (5) pipe diameters upstream or four (4) pipe diameters downstream of the meter set.

Full port ball valves or gate valves may be installed immediately upstream of the meter set, provided they are fully opened and not used to throttle flow rates through the meter.

All meters shall be equipped and installed with a remote meter reading system, to enable obtaining register reading without directly accessing the meter's location. The system shall be suitable for indoor and/or outdoor use and shall be factory sealed to prevent tampering.

32.18.1 Meter Ownership. A water meter is a device used to measure and record a consumer's water utilization. All water meters shall be purchased from the City of Grand Island; and owned by, installed, and maintained at the expense of the consumer.

32.18.2 Meter Pits and Vaults Prohibited. The water meter shall be located so that it may be easily examined and read by any such person designated by the Utilities Director to perform such functions.

Water meters shall not be located in any pit, manhole, or vault, nor an area containing fumes that are toxic, poisonous or corrosive; nor in any area in which the meter could be damaged by freezing, vibration, physical impact or structural stress; nor knowingly be allowed to conduct excessively high velocity waters.

32.18.3 Temporary Construction Water Usage. Backflow devices are required for all temporary construction or job site water usage. Meters are required on all job sites where the Contractor's hose diameter is greater than one inch (1") in size.

32.19 Fire Hydrant. All fire hydrants shall be set so that the manufacturer's "bury line" mark on the barrel of the hydrant is at the final grade for the project. There must be 18" clearance from the ground to the nozzle of the hydrant per the National Fire Protection Association. The traffic flange and bolts shall not be below grade. The Contractor shall furnish and install all fittings, offsets, and blocking required to adjust the hydrant's elevation. Hydrant extensions may be installed by the Contractor under the supervision of a Utilities Department representative, if the contractor has the required equipment and has prior approval from the Utilities Department. Hydrant extensions shall be no longer than 12". The method of adjustment shall have prior approval of the Utilities Department.

Service lines shall not be allowed to extend from the hydrant lead. The hydrant lead shall be defined as all piping downstream from the water main fitting supplying the hydrant.

32.19.1 Fire Hydrant Plumbness. Fire hydrants are to be set plumb. Hydrant plumbness shall be verified by the Utilities Department representative via visual inspection methods and/or the use of an electronic digital box level. Plumbness shall be assessed perpendicular and parallel to the driven roadway or as directed by the Utilities Department representative. Official acceptance measurements will be taken on the hydrant barrel below the bury line. To be accepted, the level measurement shall not be greater than 1.0% out of plumbness as read by the Utilities Department representative using Utilities Department equipment.

32.20 Relocation of Mains and Service Lines. When proper management, operation or maintenance of the Water System requires; or when new construction or reconstruction projects require existing water mains, lines or services to be moved, lowered, or relocated, the City Of Grand Island shall have the right to make such changes as required. All water lines that are relocated or reconstructed shall be inspected by the Grand Island Utilities Department.

32.20.1 Pressure and Testing of Relocated Mains and Service Lines. After each section of the water piping system has been relocated, and prior to being placed back in normal operation, it shall be subjected to a hydrostatic pressure test. All distribution mains will be tested at 100 PSI (minimum) and all service lines will be tested at 200 PSI (minimum at the point of relocation). This will include testing the entire section of piping isolated and taken out of service to allow the relocation work.

32.20.2 Sterilization, Flushing and Sampling of Relocated Mains & Service Lines. All sections of the water system taken out of service for relocation, or any other activities that might lead to contamination of water, shall be disinfected before being returned to service. The Contractor shall provide a temporary connection for disinfecting the newly relocated lines. Additionally, the Contractor shall provide a temporary means for flushing the isolated sections. The discharge connection shall be sized for flushing velocities not less than three (3) feet per

second, and shall include: valves, connecting piping, and hoses as required to discharge to waste.

After final flushing and before new water main is connected to the main system, two consecutive sets of acceptable samples, taken at least twenty-four (24) hours apart, shall be collected from the new main. At least one set of samples shall be collected from every 1,200 feet of the new water main, plus one set from the end of the line, and one set from each branch. Samples shall show the absence of coliform bacteria, per Nebraska DHHS requirements, to pass.

Following successful sampling and testing of the line, the Contractor shall remove all testing apparatus and plug the main at the point of injection of the disinfectant and flushing discharge.

The City will furnish personnel, pumps, chemicals, and perform the actual chlorination of the water lines taken out of service during the repair / relocation work. The City's rate for each chlorination application will be \$0.25 per linear feet of pipeline. The rate charged by the City for each set of certification samples will be five hundred dollars (\$500.00). All temporary discharge hoses, dewatering, piping, excavations, sample taps and corporations, other personnel or equipment, necessary for doing the work will remain the Contractor's responsibility.

32.20.3 Water Services on Relocated Mains. All materials necessary to relocate water service lines shall be new and un-used. Copper service pipe, laid between the water main and the curb stop, shall be built of continuous construction without joints, unions, or splices.

When required to relocate service lines under undisturbed hard surfaced roadways or driveways, trenchless methods shall be used. Any standard method of trenchless pipe installation that provides the best overall system, while providing the least disruption to the area, shall be considered for approval by the City. All service pipes shall have no less than five feet of earth cover, and in all cases shall be so protected as to prevent rupture by freezing.

The new service shall normally extend perpendicularly (90°) from the main's horizontal alignment; and connected to the existing water service at the new curb stop or valve location. All work shall be done under the direction of a licensed plumber, including the abandonment of the existing service. The Contractor shall salvage the existing curb stop (or valve) and box for the City.

32.20.4 Abandonment of Service Pipes on Relocated Mains. Water services shall be abandoned by a licensed plumber. For lead service lines, cut and crimp the line. For copper service lines, cut and sweat a cap onto the pipe. All work shall be done as close as possible to, but not to exceed one foot from the tap. The City Utilities Department shall be notified whenever a service pipe is abandoned and shall inspect and approve all work done in connection with such abandonment.

SECTION 33 – METHOD OF MEASUREMENT AND BASIS OF PAYMENT

33.01 Water Main. Water mains shall be measured for payment by measuring the length down the centerline of construction of all pipelines installed, with no deduction for fittings or valves. Payment shall be made at the contract unit price per lineal foot for various sizes, including fittings, excavation, and backfill complete in place.

It is intended that all water main pipe fittings, service lines, and appurtenances shall have five (5) feet of earth cover, or as otherwise indicated on the plans and specifications. The elevation of the piping may vary depending upon existing obstructions and proposed improvements encountered during the construction. Any deviations in alignment or grade shall have the prior approval of the Utilities Department. Where additional depth is required to clear

encountered or proposed grade interference, the additional excavation and backfill shall be incidental to the project and not a claim for extra work.

33.02 Valves and Boxes. Valves and valve boxes shall be paid for at the contract unit price complete in place.

33.03 Hydrants. Fire hydrant assemblies should be itemized and bid out as individual components. .

33.04 Manholes. Manholes shall be paid for at the contract unit price bid per manhole, for a depth of five (5) feet, which payment shall include footings, ring and cover. Additional payment shall be made for manholes more than five (5) feet in depth, measuring from top of footings to top of cover, at the contract price for each vertical foot or fraction thereof in excess of five (5) feet.

33.05 Fittings. Fittings such as tees, bends, and reducers shall be paid for at the contract unit price complete in place.

33.06 Concrete Blocking. Payment will be made as one unit for each thrust block built at the contract unit price.

33.07 Corporation Stop. Corporation stops shall be paid for at the contract unit price complete in place.

33.08 Curb Stop. Curb stops shall be paid for at the contract unit price complete in place.

33.09 Water Services. Water services shall be measured for payment by measuring the length down the center of the pipeline from the corporation stop to the curb stop. Payment shall be made at the contract unit price per lineal foot for various sizes. All excavation and backfill shall be considered subsidiary.

SECTION 34 – POLYETHYLENE ENCASEMENT

34.01 Scope of Work. This section includes the Contractor furnishing materials and installation procedures for polyethylene encasement to be applied to all underground installations of ductile-iron pipe, fittings, valves, and other appurtenances to ductile-iron pipe systems. In general, all materials and installation shall conform to the AWWA Standard, *POLYETHYLENE ENCASEMENT FOR DUCTILE-IRON PIPE SYSTEMS*, ANSI/AWWA C105/A21.5 and subsequent revisions, and as additionally specified herein.

34.01.1 Soil Testing. The Contractor shall furnish materials and shall field apply polyethylene encasement to all ductile-iron pipe, fittings, valves, and other appurtenances associated with the piping system unless such corrosion protection measures shall not be required as determined by soil testing previously conducted by the City of Grand Island.

In areas where the Utilities Department has not yet made a determination on soil characteristics, the Contractor shall have the opportunity to have performed soil tests to determine if polyethylene pipe encasement should be used. If this option is selected, the Contractor shall hire an independent testing laboratory to evaluate conditions that may affect their corrosive rate on ductile-iron pipe. Analysis shall only be conducted by personnel who are experienced in environmental factors which may contribute to the corrosion of the proposed piping system. Such test shall be at the Contractor's expense and not a claim for extra work.

All sampling collection, analysis, and evaluation shall fully comply and conform to the AWWA Standard, *POLYETHYLENE ENCASEMENT FOR DUCTILE-IRON PIPE SYSTEMS*, ANSI/AWWA C105/A21.5; APPENDIX A – “Notes on Procedures for Soil Survey Tests and Observations and Their Interpretation to Determine Whether Polyethylene Encasement Should Be Used”, and subsequent revisions.

The Contractor shall deliver to the Utilities Director certified copies of such soil test results at least 48 hours in advance of any work on the installation of the water main. The Utilities Department shall review and make a determination from the data submitted.

34.02 Materials. Film shall be high-density, cross-laminated polyethylene or linear low-density polyethylene film manufactured of virgin polyethylene material. Film shall meet all the listed requirements for polyethylene film specified in the AWWA Standard, *POLYETHYLENE ENCASEMENT FOR DUCTILE-IRON PIPE SYSTEMS*, ANSI/AWWA C105/A21.5.

The polyethylene film shall have a nominal thickness of 0.008 in. (8 mil). Tube size or sheet width for each pipe diameter shall be as listed on Standard Plan No. 155.

34.03 Installation. The polyethylene encasement shall prevent contact between the pipe and the surrounding backfill and bedding material, but is not intended to be a completely airtight or watertight enclosure. All lumps of clay, mud, cinders, etc. on the pipe surface shall be removed prior to installation of the polyethylene encasement. During the installation, care shall be exercised to prevent soil or embedment material from becoming trapped between the pipe and the polyethylene.

The polyethylene film shall be fitted to the contour of the pipe to affect a snug, but not tight, encasement with minimum space between the polyethylene and the pipe.

Sufficient slack shall be provided in contouring to prevent stretching the polyethylene where it bridges irregular surfaces, such as bell-spigot interfaces, bolted joints, or fittings, and to prevent damage to the polyethylene due to backfilling operations. Overlaps and ends shall be secured with adhesive tape or other material capable of holding the polyethylene encasement in place until backfilling operations are complete.

For installations below the water table, both ends of the polyethylene tube shall be sealed as thoroughly as possible with adhesive tape at the joint overlap. This standard includes three methods of installation of polyethylene encasement on pipe. Methods A and B are for use with polyethylene tubes and Method C is for use with polyethylene sheets.

34.03.1 Method A. (Refer to Standard Plan No. 155) Cut polyethylene tube to a length approximately two (2) ft. longer than the pipe section. Slip the tube around the pipe, centering it to provide a one (1) ft. overlap on each adjacent pipe section, and bunching it accordion-fashion lengthwise until it clears the pipe ends.

Lower the pipe into the trench and make up the pipe joint with the preceding section of pipe. A shallow bell hole must be made at joints to facilitate installation of the polyethylene tube.

After assembling the pipe joint, make the overlap of the polyethylene tube. Pull the bunched polyethylene from the preceding length of pipe, slip it over the end of the new length of pipe, and secure it in place. Take up the slack width at the top of the pipe to make a snug, but not tight, fit along the barrel of the pipe, securing the fold at quarter points.

Any cuts, tears, punctures, or other damage to the polyethylene shall be repaired. Proceed with installation of the next section of pipe in the same manner.

34.03.2 Method B. (Refer to Standard Plan No. 155) Cut polyethylene tube to a length approximately one (1) ft. shorter than that of the pipe section. Slip the tube around the pipe, centering it to provide 6” in. of bare pipe at each end. Take up the slack width at the top of the

pipe to make a snug, but not tight, fit along the barrel of the pipe, securing the fold at quarter points.

Before making up a joint, slip a 4-ft length of polyethylene tube over the end of the preceding pipe section, bunching it accordion-fashion lengthwise. After completing the joint, pull the 4-ft length of polyethylene over the joint, overlapping the polyethylene previously installed on each adjacent section of pipe by at least one (1) ft., make each end snug and secure.

Any cuts, tears, punctures, or other damage to the polyethylene shall be repaired. Proceed with installation of the next section of pipe in the same manner.

34.03.3 Method C. (Refer to Standard Plan No. 155) Cut polyethylene sheet to a length approximately two (2) ft. longer than that of the pipe section. Center the cut length to provide a one (1) ft. overlap on each adjacent pipe section, bunching it until it clears the pipe ends. Wrap the polyethylene around the pipe so that it circumferentially overlaps the top quadrant of the pipe. Secure the cut edge of polyethylene sheet at intervals of approximately 3 ft.

Lower the wrapped pipe into the trench and make up the pipe joint with the preceding section of pipe. A shallow bell hole must be made at joints to facilitate installation of the polyethylene. After completing the joint, make the overlap and secure the ends.

Any cuts, tears, punctures, or other damage to the polyethylene shall be repaired. Proceed with installation of the next section of pipe in the same manner.

34.03.4 Appurtenances. Cover bends, reducers, offsets, and other pipe-shaped appurtenances with polyethylene in the same manner as the pipe. When it is not practical to wrap valves, tees, crosses, and other odd-shaped pieces in a tube, wrap with a flat sheet or split length of polyethylene tube by passing the sheet under the appurtenance and bringing it up around the body. Make seams by bringing the edges together, folding over twice, and taping down. Tape polyethylene securely in place at valve stem and other penetrations.

34.03.5 Repairs. Repair all cuts, tears, punctures, or damage to polyethylene with adhesive tape or with a short length of polyethylene sheet or a tube cut open, wrapped around the pipe to cover the damaged area, and secured in place.

34.03.6 Openings in Encasement. Provide openings for branches, service taps, blowoffs, air valves, and similar appurtenances by making an X-shaped cut in the polyethylene and temporarily folding back the film. After the appurtenance is installed, tape the slack securely to the appurtenance and repair the cut, as well as any other damaged areas in the polyethylene, with tape. Service taps may also be made directly through the polyethylene, with any resulting damaged areas being repaired as described above.

34.03.7 Junctions between Wrapped and Unwrapped Pipe. Where polyethylene wrapped pipe joins an adjacent pipe that is not wrapped, extend the polyethylene wrap to cover the adjacent pipe for a distance of at least 3 ft. Secure the end with circumferential turns of tape.

Service lines of dissimilar metals shall be wrapped with polyethylene or a suitable dielectric tape for a minimum clear distance of 3 ft. away from the ductile-iron pipe.

34.03.8 Backfill for Polyethylene-Wrapped Pipe. Use the same backfill material as that specified for pipe without polyethylene wrap, exercising care to prevent damage to the polyethylene wrapping when placing backfill. Backfill material shall be free from cinders, refuse, boulders, rocks, stones, or other material that could damage polyethylene. In general, backfilling practice should be in accordance with the AWWA Standard, *INSTALLATION OF DUCTILE-IRON WATER MAINS AND THEIR APPURTENANCES*, ANSI/AWWA C600,

subsequent revisions, and City of Grand Island Specification Division VI, Water Mains, Section 32.13, 32.14 and 32.15, and as specified with the contract.

SECTION 35 – UNDERCROSSING

35.01 Scope of Work. This section includes the Contractor furnishing all the materials and installing complete the casing and carrier pipes. This work shall include, but is not limited to, dewatering, shoring, excavating, tunneling, jacking casing, placing casing with specified support, sealing, compacting, backfilling, and fine grading.

35.02 Casing Material. The steel casing pipe shall have a minimum wall thickness of in accordance with Standard Plan 141-A, coated inside and outside with asphalt coating double full dipped. The casing for the under crossing shall be entirely of one (1) material.

The design of such pipe is based upon the superimposed loads and not upon the loads which may be placed upon the pipe as a result of the jacking operations. Increases in pipe strength to withstand jacking loads shall be the responsibility of the Contractor.

Sections of the steel pipe casing shall be joined with a continuous full penetration butt weld for the full circumference. Joints shall be beveled before welding. No other methods shall be acceptable unless prior approval is obtained from the City. Welds shall be in full compliance with AWS D1.1-80 standards.

35.03 Procedure for Notifying Railroad/Public Entities. Unless otherwise noted on the plans, notification of work commencement must be sent to the entities noted below as indicated:

Railroad – 10 days prior to occupying or working within 25 feet of tracks and at completion of work. All aspects of the latest version of AREMA (American Railway Engineering and Maintenance-of-Way Association) must also be adhered to.

NDOT/Hall County – 48 days prior to occupying or working in Right-of-Way and also at completion of work.

G.I. Public Works Dept. – 72 hours prior to occupying or working in the Right-of-Way

35.04 Protection of Public. During the period that any work is being performed within the public right-of-way, or that an open trench or pit exists within the limits of said right-of-way, the Contractor shall furnish and utilize such signs, lights, barricades, and other devices to the extent necessary, in order to properly guide and protect the public; and shall be in accordance with State of Nebraska Department of Roads guidelines.

The Contractor shall accept full responsibility to the public, and to the right-of-way itself, for loss or damage caused by or directly traceable to his operations, actions, or inactions on or near the right-of-way.

35.05 Installation of Casing Pipe. The casing shall be so constructed and installed as to prevent leakage of any substance from the casing through its length, except at the ends. Casing shall be so installed as to prevent the formation of a waterway under the railroad or roadway, with an even bearing throughout its length, and shall slope to one (1) end. The casing shall be placed at the location and elevation shown on the drawing. No change in elevation from that shown shall be permitted without written approval from the City. Excavation shall be held to the minimum possible required for installation of liner plate. The casing shall be installed, using structural steel, plates, field bolted, to provide full round casing pipe. In advancing the casing operation, shielding or poling shall be used, together with such other measures as may become advisable to prevent settlement of the overburden. Casing pipe shall extend the entire distance, between the limits

indicated on the plans. Liner plates may extend further than this minimum requirement at no additional cost to the City, if the Contractor so elects.

After installation, the entire length of the casing shall be pressure grouted between the exterior of the tunnel liner and the adjacent soil, using a cement-sand grout of one (1) part cement to six (6) parts sand.

The casing pipe jacked into place shall be accomplished without disturbance of the road surface above. The pipe shall be jacked in the up-slope direction.

After installation of casing, and prior to backfilling any excavations, both ends of the casing shall be closed by a manner approved by the City, so as to prevent any infiltration of dirt, water, or refuse into the casing, prior to the future installation of the carrier pipe.

35.06 Excavation. The Contractor shall perform all excavations necessary for installation of the casing. The City shall have the right to limit the amount of trench that may be opened in advance of the line of work. All excavated materials not required for backfill shall be removed from the project by the Contractor. Banks of trenches shall be kept as nearly vertical as practical and, where required, shall be properly sheeted, braced, benched or sloped. Trenches shall be held to the minimum width needed to provide working space for proper installation.

All grading in the vicinity of trench excavation shall be controlled to prevent surface water from flowing into the trench. Any water accumulating in the trench shall be removed by pumping or other approved method. Material excavated from the trenches shall be stacked in an orderly manner, a sufficient distance back from edge of trenches to avoid overloading and preventing slides or cave-ins. Materials unsuitable for backfilling shall be wasted by the Contractor as directed by the City.

35.07 Backfilling. After installation of the casing, all excavations and trenches shall then be carefully backfilled as per Division VI, Water Mains Specifications, Sections 32.13, 32.14, 32.15, and other Divisions as appropriate.

35.08 Carrier Pipe. Carrier pipe shall be ductile-iron pipe with restrained joints conforming to Section 37.02.1, Division VI of the City of Grand Island Standard Specifications.

35.08.1 Carrier Pipe – Casing Spacers. Carrier pipes shall be centered within the casing by using full circle designed spacers. Spacers shall be constructed of 14 gauge, T-304 stainless steel, with a ribbed PVC extrusion insulating liner that overlaps the edges of the band and prevents slippage. Spacers, for carrier pipe diameters of 16 inches or less, shall have a minimum body width of 8 inches, and for carrier pipes, 18 inches and above, the spacer band width shall be increased to 12 inches.

Spacers risers and runners shall be properly designed to position and support the carrier pipe within the casing. Risers shall be a minimum of 10 gauge, T-304 stainless steel, MIG welded to the stainless steel body. Runners shall be ultra-high molecular weight polymer (UHMW) with a high resistance to abrasion and frictional slid wear. The runners shall be mechanically attached to the riser and the bolt heads shall be welded for strength.

Casing spacers, for pipe diameters up to 16 inches, shall have two runners on the top and two runners on the bottom. For pipe diameters 18 inches through 36 inches, spacers shall be supplied with 4 runners on the bottom and two on the top.

35.08.2 Carrier Pipe – Installation. Casing spacers shall be installed on the carrier pipe within one foot from each end of the casing pipe. For carrier pipe diameters of 16 inches or less, three spacers per length of pipe shall be installed. For carrier pipes 18 inches and above, four spacers per length of pipe shall be used.

Pipelines shall normally be installed in the center of straight casings. Risers and runners shall be dimensioned to provide a clearance of $\frac{3}{4}$ inch to the top of the casing. Refer to Standard Plan 141-A for minimum clearances between pipe bells and casing. Carrier pipes shall be pulled not pushed through the casing.

35.08.3 Carrier Pipe – Casing End Seals. After installation of the carrier pipe, the ends of the casing shall be closed against the carrier pipe to provide a backfill barrier to debris and seepage. End seals shall be made of heavy-duty neoprene or other synthetic rubber. Each end of the seal shall be secured to the pipe with T-304 stainless steel bands.

SECTION 36 – DEWATERING

36.01 General. The Contractor is responsible for devising and operating a construction dewatering system if required to install any part of the water main.

36.02 Discharge Permit. When required, facilities shall apply for authorization to discharge under a permit in compliance with the National Pollution Discharge Elimination System (NPDES).

The Owner or Operator shall use the Notice of Intent (DW-NOI) procedures to notify the Nebraska Department of Environmental Quality (NDEQ) that as a Permittee, they intend to meet all conditions of the permit. Complete and accurate information shall be submitted to the NDEQ for permission to discharge ten (10) calendar days prior to dewatering to use the construction-dewatering permit.

Nebraska Department of Environmental Quality
Wastewater Section
1200 'N' Street, Suite 400, The Atrium
PO Box 98922
Lincoln, NE 68509-8922
Tel (402) 471-4220
Fax (402) 471-2909

36.03 Dewatering Wells. If dewatering wells are used, the Contractor is required to secure all permits, properly install, and abandon the wells as per Nebraska State Statute.

SECTION 37 -- TRENCHLESS INSTALLATION OF WATER MAIN

37.01 General. Trenchless methods for the installation of pipelines requires using specialized tools, equipment and experience. The Contractor shall be well practiced with such techniques, with a minimum of five years' experience in successfully completed projects of similar size, length, and soil conditions. When required, the Contractor shall furnish the Utilities Department with a list of such jobs with the name of the purchaser, location, date, size, type, and operating conditions.

The Contractor shall provide all labor, materials, equipment, tools, dewatering, shoring, excavating, tunneling, boring with specified support, sealing, compacting, backfilling, clean-up, fine grading, and restoration of all required surface access pits, and launching and receiving pits. Additionally, it includes transporting and setting up all equipment used to perform the operations.

All work shall comply with the Ductile Iron Pipe Research Association's guidelines for "Horizontal Directional Drilling With Ductile Iron Pipe," the pipe manufacturer's recommendations, and other specifications referenced within these contract documents.

The Utilities Department reserves the right to modify sections and location of pipe installed by trenchless methods due to such factors as: soil conditions, material limitations, installation methodology, obstacles, or other causes.

37.01.1 Permits. The Utilities Department shall obtain ingress and egress permits, right-of-way, and easements required for the work, where required. Other permits required for the performance of the work shall be obtained by the Contractor.

37.01.2 Site Investigation. The Contractor shall determine the types and locations of surface and subsurface utilities and materials, soil types, groundwater, and other environmental factors and shall determine their effect on the bore installation.

All site investigations required shall be the responsibility of the Contractor. If utilities of unknown depth or other obstructions will require grade or alignment deviations from the plans, the grade or alignment may be adjusted with the prior approval of the Utilities Department.

37.02 MATERIALS

37.02.1 Restrained Joint Pipe. Pipe shall be ductile iron with restrained push-on joints conforming to the AWWA Standard, *DUCTILE-IRON PIPE, CENTRIFUGALLY CAST*, ANSI/AWWA C151/A21.51 and Section 31, Division VI of the City of Grand Island Standard Specifications.

Pipe shall be cement mortar lined conforming to the AWWA Standard, *CEMENT-MORTAR LINING FOR DUCTILE-IRON PIPE AND FITTINGS*, ANSI/AWWA C104/A21.4 and subsequent revisions. All cement mortar lining shall be coated with asphaltic seal coat in conformity with referenced standard specifications.

Pipe shall be designed for a working pressure of 350 psi, with boltless, restrained, flexible joints, that have smoothly contoured bells. Joint designs that restrict smooth installation, increase pulling forces, or degrade the flow of drilling fluid around the joint shall not be used. Pipe and joint seals shall be capable of handling the internal pressures, external pressures, torque, and vacuum that can occur during pull-back along the bore path.

37.02.2 Pulling Heads. The pipe pulling head shall have the same characteristics as the pipe to which it is attached. Pulling heads, reamers, and swivel assemblies shall be designed and furnished by the pipe manufacturer, or an approved equal in full compliance with the pipe manufacturer's requirements.

37.02.3 Polyethylene Encasement. All pipe shall have polyethylene encasement, as per Grand Island Standard Specifications, Section 34, and as additionally specified herein.

Use only tube-type polyethylene sleeves with a nominal thickness of 0.008 in. (8 mil). Installation shall be per AWWA Standard, ANSI/AWWA C105/A21.5 "Alternate Method 'A' or Wet Trench Conditions" as modified herein. Polyethylene tubing shall be secured to the first length of pipe with several wraps of tape directly to both the pipe barrel and tubing, approximately one foot from the spigot end. Ensure that all excess material is neatly folded longitudinally, and secured around the barrel section by circumferential tape wraps at a maximum of two foot spacing. The polyethylene tubing should always overlap back over the bell and joint section to ensure that drilling fluid is not forced under the polyethylene during pull-back. Secure the polyethylene at the joint area with circumferential tape wraps on each side of the joint. Continue installation opposite to the direction of pull-back.

37.03 PIPE INSTALLATION

37.03.1 Drilling System. The Contractor shall have the equipment and expertise appropriate for horizontal direction drilling operations and pipeline installation.

The equipment shall consist, as a minimum of a system capable of performing the bore and pulling back the pipe, with a boring mixture delivery and fluid recovery system of sufficient appropriate capacity, and a guidable drill head capable of carrying out the drilling and piping installation. The equipment shall be designed to withstand the pulling, pushing and rotating pressure involved to complete the work, and equipped to monitor and record the pull-back pressure during the pull-back operation. The drill head shall be steerable and shall be provided with necessary cutting surfaces and drilling fluid jets as required.

37.03.2 Guidance System. The bore shall utilize a proven guidance probe and interface to accurately determine the location of the drill head during the drilling operation. It shall be capable of tracking at the required installation depth in any soils encountered and enable the operator to adjust the drill head both horizontally and vertically.

37.03.3 Drilling Fluid System. A self-contained system of sufficient size to mix and deliver the boring fluid shall be provided. Tank capacities shall be sized to hold excess material completely by containing "mud" quantities without spillage. The entry point shall be appropriately enclosed and equipped with a sump pump to reclaim or discharge excess drilling fluids to a reuse or disposal tank. The system shall be able to ensure thorough mixing of all components of the slurry to avoid clumping. The boring fluid shall be continually agitated by the mixing system. No discharge of excess material or site runoff will be allowed.

37.03.3.1 Drilling Fluid. The drilling fluid shall be comprised of clean potable water, bentonite clay, and appropriate additives. The Contractor shall be responsible for obtaining, transporting, and/or storage of any water required for drilling fluids. Additives shall be environmentally safe, non-toxic, and approved for such usage. The boring fluid shall be of a consistency to suspend the cuttings and maintain the integrity of the bore walls.

37.03.4 Excavations. The Contractor shall be responsible for all excavations and properly maintaining trench banks, sheeting, bracing, benching, and sloping as required. Excavations shall be of sufficient width to provide proper working space for drilling operations and down hole assemblies. Material excavated from the trenches shall be stacked in an orderly manner a sufficient distance back from edge of excavations to avoid overloading and preventing slides or cave-ins.

Excavations shall be located for proper installation of the pipeline. The insertion / assembly pits may also subsequently be used for connections, installing valves, fittings, or hydrant assemblies at locations indicated on the plans.

37.03.5 Pilot Hole. Install the pilot hole using a steerable drilling head. The pilot hole shall be drilled along the planned bore path and alignment, to the tolerances listed and concurrent with safe operations. Proper setbacks shall be maintained to avoid excessively steep entry and exit of the pilot hole. In all cases, the transition from the surface to the bore path shall be within the pipe manufacturer's allowable joint deflection.

The Contractor has the option to pre-ream the pilot hole. However, lack of pre-reaming shall not place excessive loading on the installation of the pipeline. Any damage to the pipeline resulting from inadequate pre-reaming shall be the responsibility of the Contractor.

37.03.6 Alignment. The bore path shall be to the elevations and alignment indicated on the drawings and as staked for the contractor. The installation shall be guided by equipment that gives continuous, accurate monitoring and done without disturbing the area surfacing, ditch lines, or waterways.

The Contractor shall continuously monitor the bore alignment at all times when the bore operation is proceeding. When the alignment goes beneath a body of water, a visual inspection shall be made at the most accessible point immediately downstream of the bore alignment for changes in turbidity or color, which may indicate a subsurface breach in the boring operation.

Pipe entry and exit points may be moved further from the original plan only with prior approval of the Utilities Department. Any bore exit to the surface, other than for the final location, shall be plugged and stabilized before proceeding, and the exit site shall be restored to its original condition.

Deviations from the alignment indicated on the plans may be allowed providing:

- No deviation shall be greater than 5% of depth per 100' of installed length;
- All piping shall be installed with a minimum of five (5) feet of earth cover;
- The pipeline shall not interfere with proposed infrastructure locations, or the safe operation and maintenance of existing utilities or structures;
- The pipeline shall not encroach beyond the right-of-way, easement, or construction limits.

In cases where the pipe is outside of the specified limits, or otherwise deviates more than the approved maximum, the Contractor shall re-install the pipe to the accepted alignment and elevation at their own expense.

37.03.7 Installation – Cartridge Method. The Cartridge Assembly Method shall be the preferred option for assembling pipe sections due to right-of-way limitations.

The individual pipe sections shall be joined in the insertion pit. Each section shall then be progressively pulled into the bore path a distance equivalent to a single pipe section. The process is repeated until the entire length is pulled through the bore path to the exit point.

37.03.8 Pull-Back. After successfully reaming of the bore hole, the Contractor shall attach a swivel connector between the final reamer and the pulling head and pull the pipe through the bore hole. Once pull-back operations have commenced, the operations shall continue without interruption until the pipe is completely pulled back through the bore hole. Pipe shall only be pulled from the plain end to minimize pulling forces and to take advantage of the bell transition.

If excessive pull-back is encountered, or the pipe becomes immovable, the Contractor shall stop the pull-back operations to allow any potential hydro-lock to subside, then pulling operations will again commence. If the pipe remains stuck, the Contractor shall notify the City to discuss options or alternatives, and then work shall proceed in accordance with those decisions.

37.03.9 Pulling Force. Restrained push-on joint pipe must be capable of withstanding the pulling forces used to install the pipe through the bore hole. The pulling force shall be limited to the joints maximum dead-end thrust load at the rated working pressure, and in full compliance with the pipe manufacturer's recommendations.

37.03.10 Backfill and Clean-Up. Disposal and clean-up of excess drilling fluid and pits shall be the responsibility of the Contractor. Disposal shall not be allowed on the project site. All work shall be done in accordance with environmental regulations, right-of-way limits, and permit requirements.

The Contractor shall backfill all excavations with suitable compacted materials as required. Earth spoiled by drilling mud or where other deleterious backfill substances are

encountered, the material shall be rejected, hauled away, and disposed of by the Contractor and the site refilled with clean material. The area shall be restored to a condition equal to or better than its original condition.

Materials to be removed from the job site shall be disposed of properly. If materials are to be disposed of on private property, prior written permission shall be obtained from the owner of the property, and submitted to the City's designated representative.

All materials, trash, and debris shall be removed by the Contractor from the construction limits in a timely manner.

37.04 RECORDS AND MEASUREMENTS

37.04.1 Records. The Contractor shall keep a daily log of all drilling activities and records indicating the pull-back loads exerted on the pipe for each section installed. A copy shall be provided to the City Utilities Department upon completion of the boring procedure. When monitoring records indicated the pullback forces exceed the pipe manufacturer's loading recommendations, the pipeline may be rejected.

The field records and notes shall additionally specify: the type of equipment used; the length and depth of the installation; and existing utility locations.

37.04.2 Measurement for Payment. The installation of bored pipe will be measured for payment by the linear foot of the various sizes of pipe acceptably installed. Measurement will be for full length of placement as verified in the field.

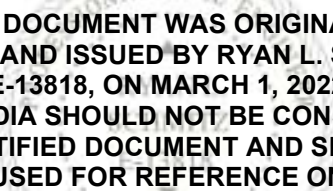

**THIS DOCUMENT WAS ORIGINALLY
SEALED AND ISSUED BY RYAN L. SCHMITZ
E-13818, ON MARCH 1, 2022
THIS MEDIA SHOULD NOT BE CONSIDERED
A CERTIFIED DOCUMENT AND SHOULD
BE USED FOR REFERENCE ONLY.**

STATUS OF UTILITIES

18th Street – Moores Creek Drainway to Diers Avenue
 Paving Project #2022-P-8
 Grand Island, NE

The following information is current as of 9/29/2022

Aerial and/or underground utilities facilities existing within this project. The contractor shall determine to his/her satisfaction the extent of the utility conflict for facilities located within the construction areas.

| Utility Company Within Vicinity of Project | Actual/ Anticipated Utility Starting Date | Actual/ Anticipated Utility Completion Date |
|---|--|---|
| City of Grand Island Water Main Ryan Schmitz 308-385-5463, ext. 2132 1306 W. 3rd Street, Grand Island, NE 68801 rschmitz@giud.com | | |
| City of Grand Island Electrical Travis Burdett 308-385-5466 700 E. Bischeld Street Grand Island, NE 68801 tburdett@giud.com | | |
| City of Grand Island Sanitary Sewer Keith Kurz 308-389-0274 100 E. 1 st Street Grand Island, NE 68801 keithk@grand-island.com | | |
| City of Grand Island Streets Department Shannon Callahan 308-385-5322 1111 W. North Front Street Grand Island, NE 68801 shannonc@grand-island.com | | |

| | | |
|--|--|--|
| Lumen Scott Wilson 402-572-6457 7404 N 78 th Street Omaha, NE 68122 William.wilson2@centurylink.com | | |
| Northwestern Energy Luke Choyeski 308-385-4503 1023 E. 25 th Street Kearney, NE 68847 Luke.choyeski@northwestern.com | | |
| Allo Communications Wes Malone 308-660-8644 725 W 1 st Street Hastings, NE 68901 Wesley.malone@allofiber.com | | |
| Charter Communications Doug Sanders 308-930-9411 205 N. Webb Road Grand Island, NE 68803 Douglas.sanders@charter.com | | |

The Contractor should request a utility status update at the preconstruction conference, and/or prior to starting work.

Any utility adjustments or interruption of service for the convenience of the Contractor shall be the sole responsibility of the Contractor.

To arrange for utilities to locate and flag their underground facilities, contact Diggers Hotline of Nebraska at 1-800-331-5666, or dial 811.

It is the responsibility of the contractor to cooperate and coordinate his/her work with any utility work to be done concurrent with construction to complete both promptly. The contractor shall determine to his/her satisfaction the extent of the utility occupancy and utility conflict for facilities located within the construction areas, including determining impacts and timeframes for completion.

The following is for the contractors' information only; it is the contractors' responsibility to verify the accuracy of the information.

CITY OF GRAND ISLAND

The City of Grand Island has existing overhead and underground electric items, water main, water services, sanitary sewer trunk line and sanitary sewer services within the limits of the project.

Overhead Electric

An overhead electric distribution line crosses the proposed roadway at approximately Station 101+80. A pole associated with this line, located approximately 28 feet left of roadway centerline will conflict with proposed storm sewer pipe and concrete pavement and will be relocated concurrent with construction.

An overhead electric transmission line crosses the proposed roadway at approximately Station 102+04. No conflicts are anticipated with this line.

Underground Electric

An underground electric line crosses the proposed roadway at approximately Station 109+02. This line will conflict with grading, paving and storm sewer construction and will be lowered concurrent with construction.

Roadway Lighting

Roadway lights at Stations 104+19 and 106+20 will be removed concurrent with construction. New light poles, conduits and circuitry will be placed by the City of Grand Island following pavement construction.

Water

An 8" water main runs along the north side of Aspen Circle from approximately Station 104+00 to Station 106+50 at varied distances from the existing roadway. Two fire hydrants associated with this line are located at Stations 104+19 and 106+28. This water main and hydrants will be removed and/or vacated and replaced with new main and hydrants as shown in the plans.

Sanitary Sewer

A 10" sanitary sewer line runs approximately along the centerline of the existing Aspen Circle from Station 103+70 to Station 106+90. No conflicts are anticipated with this line but manholes at Stations 103+72, 104+44, 105+86 and 106+83 will be adjusted to grade as shown in the plans.

A 15" sanitary sewer line runs north-south, crossing the roadway at approximately Station 108+85. No conflicts are anticipated with this line but a manhole at Station 108+60 – 100' Rt will be adjusted to grade as shown in the plans.

NORTHWESTERN ENERGY

A Northwestern energy gas main of unknown size crosses the proposed roadway at approximately Station 109+00. This line will conflict with grading, paving and storm sewer construction and will be lowered concurrent with construction.

LUMEN

Lumen has two 72 pair fiber optic lines crossing the roadway at approximately Station 101+84 and one 96 pair fiber optic line crossing the roadway at approximately Station 101+94. These lines will conflict with grading, paving and storm sewer construction and will be lowered concurrent with construction.

Lumen has a copper cable of unknown size crossing the roadway at approximately Station 108+92. This line will conflict with grading, paving and storm sewer construction and will be lowered concurrent with construction. A riser associated with the copper cable and located at Station 108+99 – 31' Rt will be in conflict with sidewalk construction and will be relocated concurrent with construction.

ALLO COMMUNICATIONS

Allo Communications has a fiber optic line of unknown size that crosses the roadway at approximately Station 101+90. This line will conflict with grading, paving and storm sewer construction and will be lowered concurrent with construction.

CHARTER COMMUNICATIONS

Charter Communications has a cable television line that crossed the roadway at approximately Station 108+95. This line will conflict with grading, paving and storm sewer construction and will be lowered concurrent with construction.

18TH STREET - MOORES CREEK TO DIERS AVENUE ROADWAY IMPROVEMENTS; PROJECT #2022-P-8 GRAND ISLAND, NEBRASKA 2022

GENERAL NOTES

1. ALL WORK SHALL BE IN ACCORDANCE WITH THE CITY OF GRAND ISLAND STANDARD SPECIFICATIONS AND STANDARD DRAWINGS.
2. THE LOCATION OF ALL AERIAL AND UNDERGROUND UTILITY FACILITIES MAY NOT BE INDICATED ON THESE PLANS. UNDERGROUND UTILITIES, WHETHER INDICATED OR NOT WILL BE LOCATED AND FLAGGED BY THE UTILITIES AT THE REQUEST OF THE CONTRACTOR. NO EXCAVATION WILL BE PERMITTED IN THE AREA OF UNDERGROUND UTILITY FACILITIES UNTIL ALL SUCH FACILITIES HAVE BEEN LOCATED AND IDENTIFIED TO THE SATISFACTION OF ALL PARTIES. THE EXCAVATION MUST BE ACCOMPLISHED WITH EXTREME CARE IN ORDER TO AVOID ANY POSSIBILITY OF DAMAGE TO THE UTILITY FACILITY. THE CONTRACTOR SHALL BE RESPONSIBLE FOR ALL DAMAGES.
3. CONTRACTOR SHALL PRESERVE ALL PROPERTY CORNER MONUMENTS OR RE-ESTABLISH THEM IF THEY ARE DISTURBED DURING CONSTRUCTION AT THEIR COST.
4. THE CONTRACTOR SHALL OBTAIN AND PAY THE COST OF ALL REQUIRED PERMITS AND FEES.
5. GENERAL FILL AND BACKFILL SHALL BE COMPACTED TO A MINIMUM OF 98% OF THE STANDARD PROCTOR MAXIMUM DRY DENSITY UNDER PAVED AREAS AND 92% UNDER TURF AREAS.
6. THE TRENCHES SHALL BE BACKFILLED, MECHANICALLY TAMPED AND TESTED. BACKFILL SHALL BE COMPACTED TO A MINIMUM OF 98% OF THE STANDARD PROCTOR MAXIMUM DRY DENSITY UNDER PAVED AREAS, SIDEWALK AND TRAILS AND 92% UNDER TURF AREAS.
7. PAVEMENT SUBGRADE SHALL BE COMPACTED TO A MINIMUM OF 98% OF THE STANDARD PROCTOR MAXIMUM DRY DENSITY.
8. THE ENGINEER SHALL DEVELOP A STORM WATER POLLUTION PREVENTION PLAN AND THE CONTRACTOR SHALL BE RESPONSIBLE FOR ITS IMPLEMENTATION.
9. APPROXIMATE EARTHWORK QUANTITIES. NO BALANCE FACTOR APPLIED.
EXCAVATION = 2200 CY
EMBANKMENT = 600 CY
10. MAX JOINT SPACING FOR 8" CONCRETE PAVEMENTS SHALL BE 12' UNLESS NOTED OTHERWISE.
11. ANY PANELS THAT CONTAIN RANDOM CRACKING WILL BE CONSIDERED UNACCEPTABLE. THE ENGINEER WILL DECIDE WHETHER TO REPLACE OR REPAIR THE PANEL. THE CONTRACTOR SHALL REPLACE OR REPAIR THESE PANELS AT THE DIRECTION OF THE ENGINEER AT NO COST TO THE OWNER. A 20% DEDUCTION WILL BE ASSESSED ON A REPAIRED PANEL. ANY PANEL THAT IS REPLACED WILL NOT BE ASSESSED A 20% DEDUCTION.
12. CONSTRUCTION OF ALL JOINTS INCLUDING DOWELS AND TIE BARS SHALL BE CONSIDERED SUBSIDIARY TO CONCRETE PAVEMENT.
13. SAWCUTTING PAVEMENT FOR REMOVAL SHALL BE CONSIDERED SUBSIDIARY.
14. THE ROADWAY PAVEMENT SHALL HAVE A BURLAP DRAG FINISH. DRIVEWAY AND SIDEWALK PAVEMENT SHALL HAVE A LIGHT BROOM FINISH.
15. ALL PAVEMENT INCLUDING, DRIVEWAYS AND SIDEWALKS SHALL BE NDOT CONCRETE CLASS 47B-3500 UTILIZING 1P OR 1S CEMENT IN ACCORDANCE WITH THE 2017 STANDARDSPECIFICATIONS FOR HIGHWAY CONSTRUCTION.
16. CONSTRUCTION OF CURB RAMPS SHALL BE CONSIDERED SUBSIDIARY TO CONCRETE SIDEWALK AND SHALL FOLLOW DETAILS PROVIDED.
17. CONSTRUCTION STAKING SHALL BE COMPLETED BY THE ENGINEER.
18. THE CONTRACTOR IS REQUIRED TO KEEP STORM SEWER CLEAN FOR DURATION OF THE PROJECT.
19. WATER MAIN REMOVAL FOR STORM SEWER CONSTRUCTION SHALL BE CONSIDERED SUBSIDIARY TO THE STORM SEWER CONSTRUCTION. CONTRACTOR TO CONCRETE CAP BOTH ENDS OF WATER MAIN TO BE ABANDONED IN PLACE.
20. ADJUSTMENT OF CURB STOP BOXES TO GRADE SHALL BE CONSIDERED SUBSIDIARY.
21. THE GROUNDWATER ELEVATION AS OF 7/30/2022 WAS 1861.5 RECORDED AT WELL 8 NEAR THE INTERSECTION OF US-281 AND 13TH STREET. THE RECORD HIGH ELEVATION IS 1865.6 AT THIS LOCATION ON 5/25/1984.
22. CONTRACTOR SHALL PAY RE-STAKING COST ON AN HOURLY BASIS.
23. ALL PAVEMENT MARKINGS SHALL BE IN ACCORDANCE WITH NEBRASKA DEPARTMENT OF TRANSPORTATION STANDARD SPECIFICATIONS FOR HIGHWAY CONSTRUCTION, 2017 EDITION AND MANUAL ON UNIFORM TRAFFIC CONTROL DEVICES.
24. PAVEMENT MARKINGS SHALL BE GROOVED UNLESS NOTED OTHERWISE.
25. EXISTING SIGNAGE SHALL BE REMOVED AND SALVAGED TO THE CITY OF GRAND ISLAND.
26. ALL SIGNS SHALL BE APPROVED BY THE CITY OF GRAND ISLAND STREETS DEPARTMENT PRIOR TO ORDERING.
27. PRIOR TO MOVING OFF SITE THE CONTRACTOR SHALL NOTIFY THE ENGINEER IN WRITING REQUESTING A FINAL WALK-THROUGH OF THE PROJECT.



| DRAWING INDEX | |
|---------------|---------------------------------|
| 1 | COVER SHEET |
| 2-4 | PHASING |
| 5 | TRAFFIC CONTROL PLAN |
| 7 | HORIZONTAL AND VERTICAL CONTROL |
| 8-10 | GENERAL INFORMATION |
| 12-15 | PLAN AND PROFILE |
| 16-18 | REMOVALS |
| 19-21 | CONSTRUCTION |
| 22-24 | GEOMETRICS, JOINTS AND GRADES |
| 25-28 | WATER MAIN |
| 29-31 | EROSION CONTROL |
| 32-35 | RIGHT OF WAY |
| X1-X9 | CROSS SECTIONS |

LEGEND

| | | |
|-------------------------|-----|---|
| STORM SEWER | SD | — |
| SEWER LINE | SS | — |
| WATER LINE | W | — |
| GAS LINE | GAS | — |
| TELEPHONE LINE | UTE | — |
| OVERHEAD ELECTRIC | OHE | — |
| UNDERGROUND ELECTRIC | UGE | — |
| MANHOLE | | ○ |
| CULTIVATED LAND LINE | | — |
| INLET/JUNCTION BOX | | □ |
| VALVE | | ⊕ |
| FIRE HYDRANT | | ⊕ |
| POWER POLE | | ⊕ |
| STREET LIGHT | | ⊕ |
| STREET LIGHT/POWER POLE | | ⊕ |
| GUY | | — |
| BUSH | | ⊕ |
| TREE | | ⊕ |
| BUSH | | ⊕ |
| STUMP | | ⊕ |
| SIGN | | ⊕ |
| CULVERT | | — |
| CHAIN LINK FENCE | | — |
| WOODEN/PLASTIC FENCE | | — |
| BARBED WIRE FENCE | | — |
| CURB STOP | | ⊕ |
| GAS METER | | ⊕ |
| ELECTRICAL METER | | ⊕ |
| TELEPHONE RISER BOX | | ⊕ |
| PROPERTY CORNER | | ⊕ |
| SEWER CLEAN OUT | | ⊕ |
| POST | | ⊕ |
| PROPERTY LINE/R.O.W. | | — |
| EASEMENT LINE | | — |

DWG: F:\2021\07001-07500\021-07494\40-Design\AutoCAD\Final Plans\Sheets\GNCV\18th Street\C_COV-18TH St_02107494.dwg
 DATE: Dec 19, 2022 2:22pm
 USER: zoomis
 XREFS: C:\TTLBLK-18TH_02107494

olsson

201 East 2nd Street
 Grand Island, NE 68801
 TEL 308.384.8750
 www.olsson.com

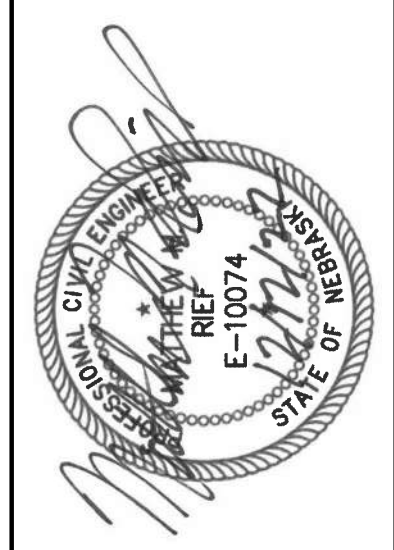

| REV. NO. | DATE | REVISIONS DESCRIPTION |
|----------|------|-----------------------|
| | | |
| | | |
| | | |
| | | |

| | |
|---|------|
| COVER SHEET | 2022 |
| 18TH STREET - MOORES CREEK TO DIERS AVENUE ROADWAY IMPROVEMENTS; PROJECT #2022-P-8 | |
| GRAND ISLAND, NEBRASKA | |

drawn by: _____
 checked by: _____
 approved by: _____
 QA/QC by: _____
 project no.: 021-07494
 drawing no.: _____
 date: 12.19.2022

DWG: F:\2021\07001-07500\021-07494\40-Design\AutoCAD\Final Plans\Sheets\GNCV\18th Street\C_PHS-18TH St_02107494.dwg
 DATE: Dec 19, 2022 2:23pm XREFS: C_PBASE-Link_02107494 V_XTPOPO_LDP_02107494 C_TTLBLK-18TH_02107494 V_XRWAY_LDP_02107494 USER: zloomis

GENERAL PHASING NOTES

1. ALL PHASES WILL BE CONSTRUCTED UNDER FULL CLOSURE WITH SIGNED TEMPORARY TRAFFIC CONTROL.
2. THE ORDER OF PHASES IS A CONTRACTOR OPTION AS LONG AS ACCESS IS MAINTAINED TO BUSINESSES ALONG THE CORRIDOR AND AS NOTED ON THE INDIVIDUAL PHASING SHEETS. ADDITIONALLY, BOTH PHASES MAY BE COMPLETED CONCURRENTLY AS LONG AS ACCESS IS MAINTAINED AS NOTED ON INDIVIDUAL PHASING SHEETS. CONSTRUCTION PHASING SCHEDULE MUST BE SUBMITTED TO THE CITY FOR REVIEW AND APPROVAL PRIOR TO PROCEEDING.
3. TEMPORARY ROCK SURFACING SHALL BE PLACED AS DIRECTED BY THE ENGINEER FOR PROPERTY ACCESS AND CONSTRUCTION PHASING.

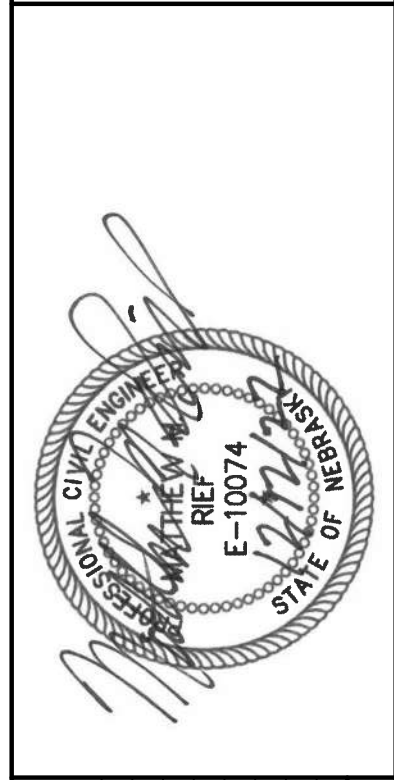
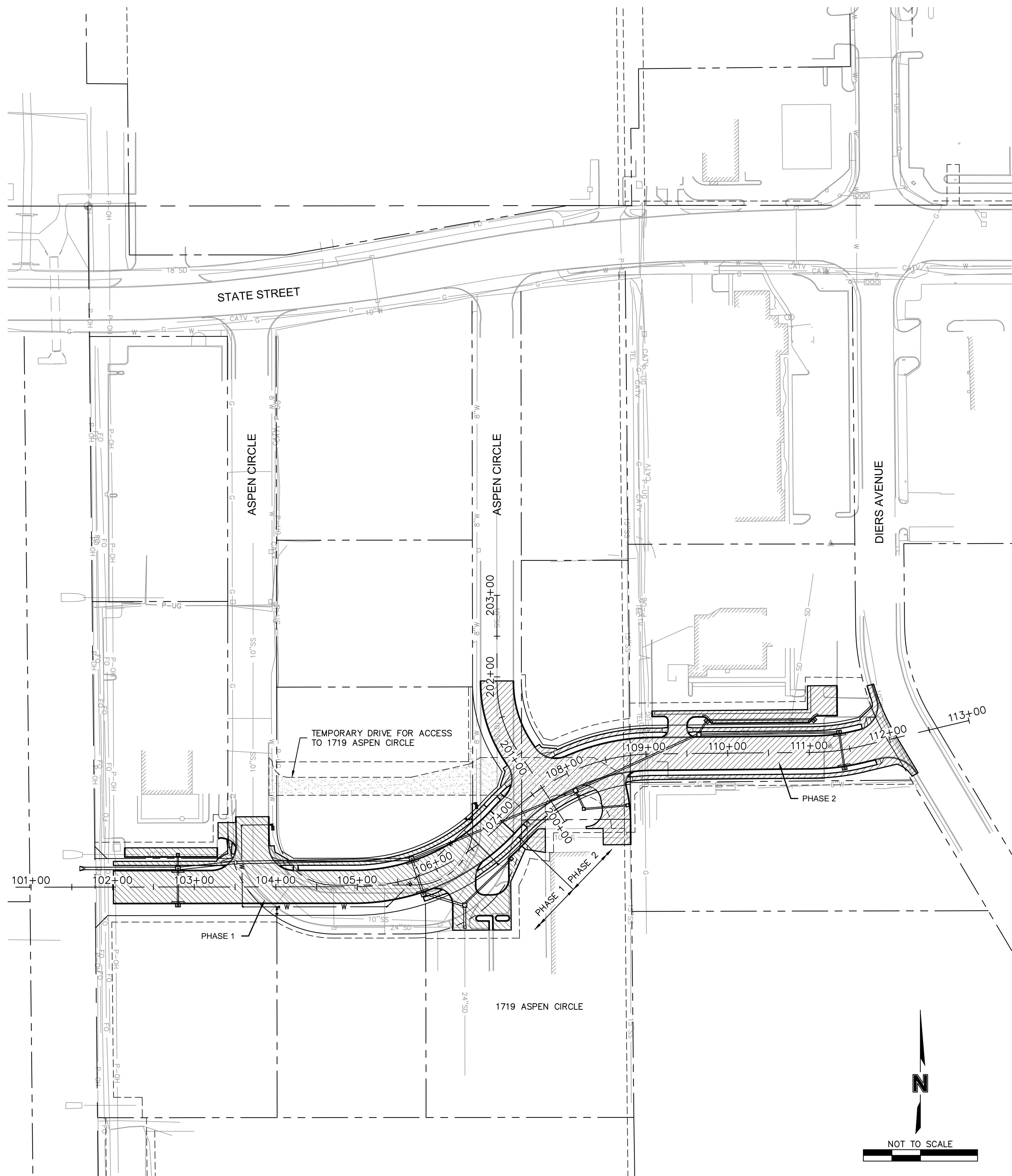

| REV. NO. | DATE | REVISIONS DESCRIPTION |
|----------|------|-----------------------|
| | | |
| | | |
| | | |
| | | |

| PHASING OVERVIEW | REVISIONS |
|---|-----------|
| 18TH STREET - MOORES CREEK TO DIERS AVENUE ROADWAY IMPROVEMENTS; PROJECT #2022-P-8 | 2022 |
| GRAND ISLAND, NEBRASKA | |

drawn by: ZL
 checked by: ZL
 approved by: MMR
 QA/QC by: MMR
 project no.: 021-07494
 drawing no.:
 date:

DWG: F:\2021\07001-07500\021-07494\40-Design\AutoCAD\Final Plans\Sheets\GNCA\18th Street\18th St_02107494.dwg
 DATE: Dec 19, 2022 2:23pm XREFS: C_PBASE-Link_02107494 V_XTOPO_LDP_02107494 C_TTLBLK-18TH_02107494 V_XRWAY_LDP_02107494 USER: zloomis

PHASE 1 NOTES

1. CONSTRUCTION OF ROADWAY, STORM SEWER, DRIVEWAYS AND SIDEWALK FROM STATION 107+00 TO STATION 112+09.
2. ASPEN CIRCLE TO BE CLOSED TO THROUGH TRAFFIC.
3. TWO-WAY TRAFFIC SHALL BE MAINTAINED ON DIERS AVENUE AT ALL TIMES.
3. ACCESS TO 1719 ASPEN CIRCLE SHALL BE MAINTAINED AT ALL TIMES THROUGH THE NEWLY CONSTRUCTED WEST DRIVEWAY.

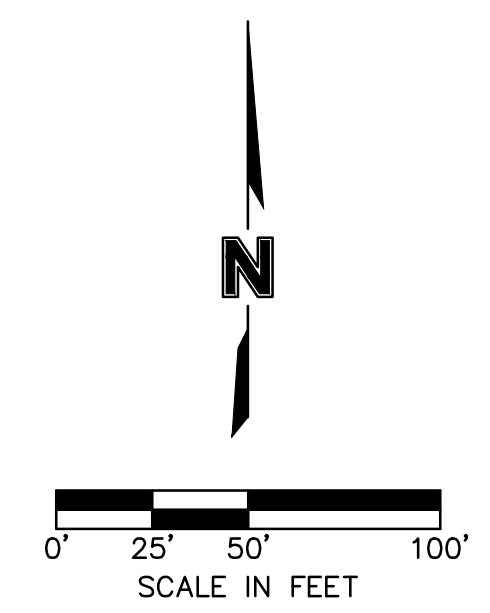
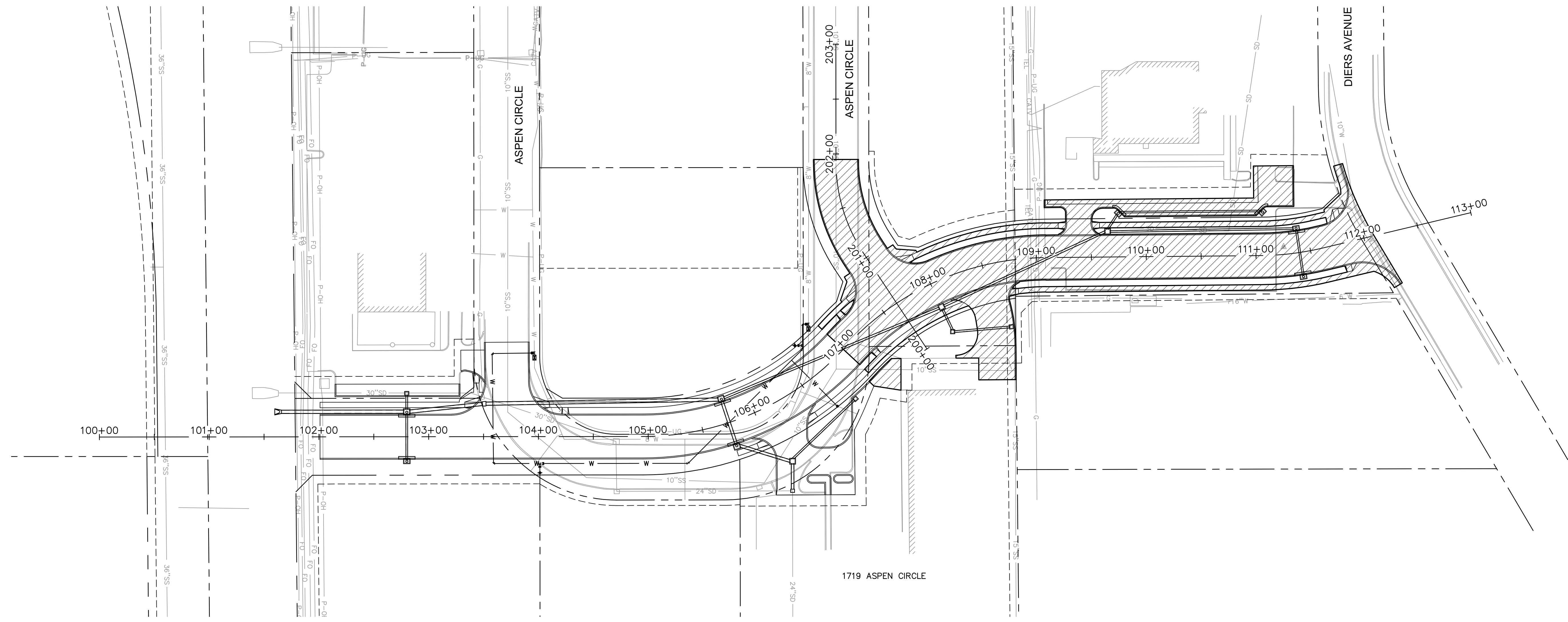

| REV. NO. | DATE | REVISIONS DESCRIPTION |
|----------|------|-----------------------|
| | | |
| | | |
| | | |
| | | |
| | | |

| | |
|---|------|
| PHASE 2 | 2022 |
| 18TH STREET - MOORES CREEK TO DIERS AVENUE ROADWAY IMPROVEMENTS; PROJECT #2022-P-8 | |
| GRAND ISLAND, NEBRASKA | |

drawn by: ZL
 checked by: ZL
 approved by: MMR
 QA/QC by:
 project no.: 021-07494
 drawing no.:
 date:

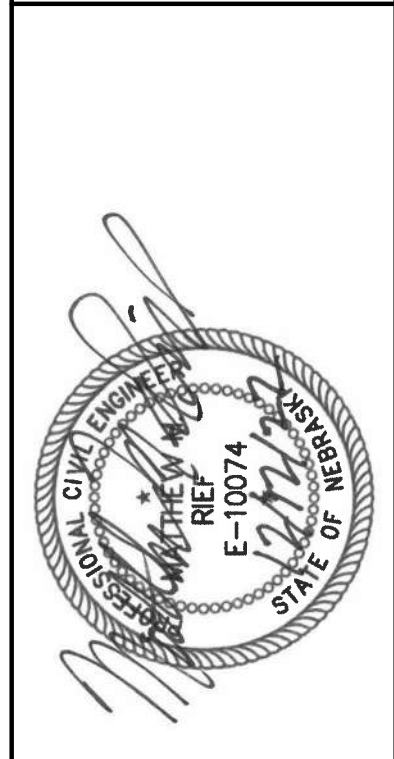

DWG: F:\2021\07001-07500\021-07494\40-Design\AutoCAD\Final Plans\Sheets\GNCV\18th Street\18TH St_02107494.dwg
 DATE: Dec 19, 2022 2:25pm XREFS: C_PBASE-Link_02107494 V_XTOPD_LDP_02107494 C_TTLBLK-18TH_02107494 C_AERL_02107494 USER: zicommis

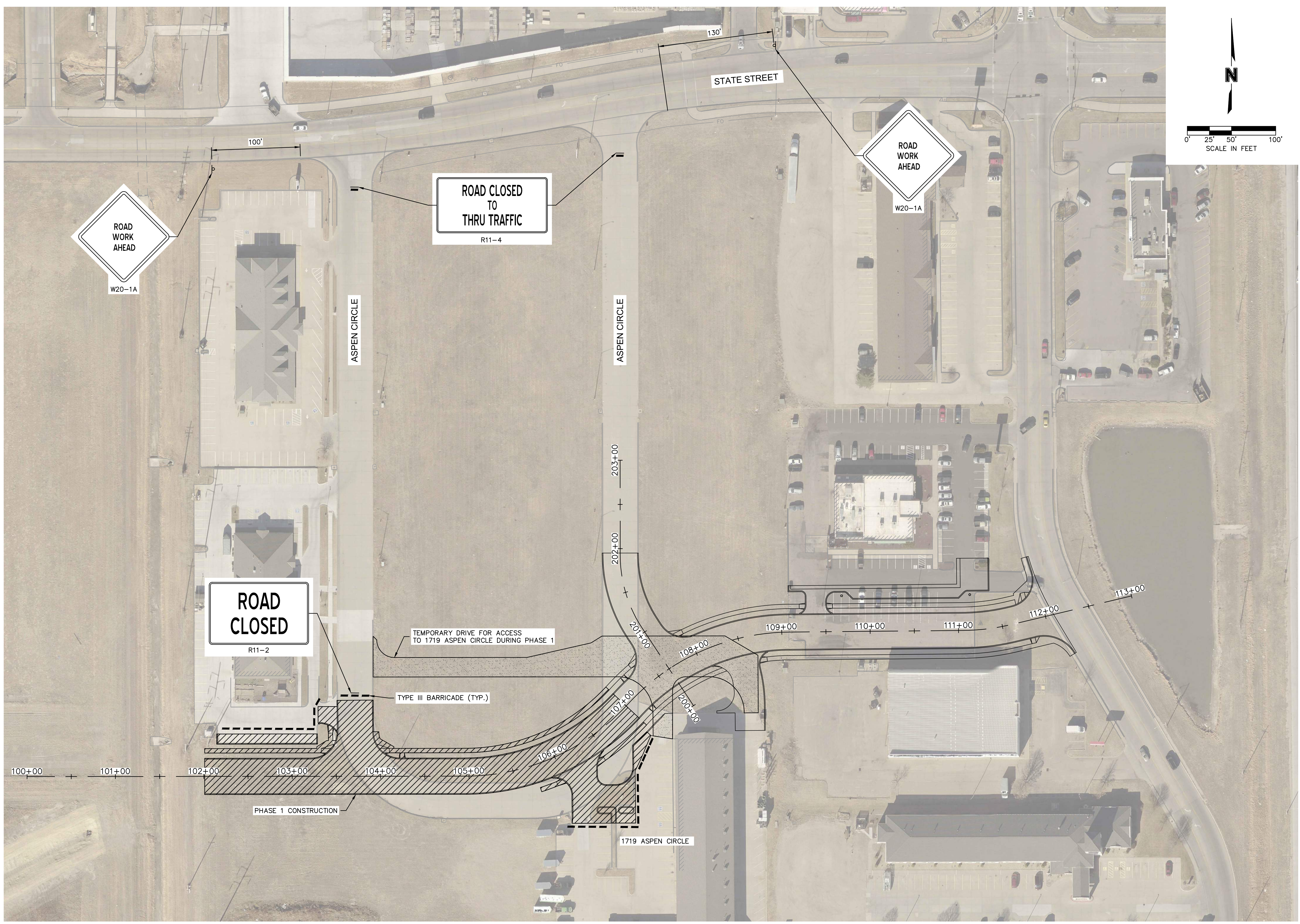

olsson

201 East 2nd Street
Grand Island, NE 68801 TEL 308.384.8750 www.olsson.com

SCALE IN FEET
0' 25' 50' 100'

ROAD WORK AHEAD
W20-1A

ROAD CLOSED TO THRU TRAFFIC
R11-4

ROAD WORK AHEAD
W20-1A

ROAD CLOSED
R11-2

TEMPORARY DRIVE FOR ACCESS TO 1719 ASPEN CIRCLE DURING PHASE 1

TYPE III BARRICADE (TYP.)

PHASE 1 CONSTRUCTION

1719 ASPEN CIRCLE

| REV. NO. | DATE | REVISIONS DESCRIPTION | REVISIONS |
|----------|------|-----------------------|-----------|
| | | | |
| | | | |
| | | | |
| | | | |
| | | | |
| | | | |
| | | | |
| | | | |
| | | | |
| | | | |

TEMPORARY TRAFFIC CONTROL PLAN - PHASE 1

18TH STREET - MOORES CREEK TO DIERS AVENUE
ROADWAY IMPROVEMENTS; PROJECT #2022-P-8

GRAND ISLAND, NEBRASKA

2022

| | |
|--------------|-----------|
| drawn by: | ZL |
| checked by: | ZL |
| approved by: | MMR |
| QA/QC by: | |
| project no.: | 021-07494 |
| drawing no.: | |
| date: | |

SHEET
5 of 35

DWG: F:\2021\07001-07500\021-07494\40-Design\AutoCAD\Final Plans\Sheets\GNCV\18th Street\18th St_02107494.dwg
 DATE: Dec 19, 2022 2:25pm XREFS: C_PBASE-Link_02107494 V_XTOPO_LDP_02107494 C_TTLBLK-18TH_02107494 C_AERL_02107494 USER: zicommis

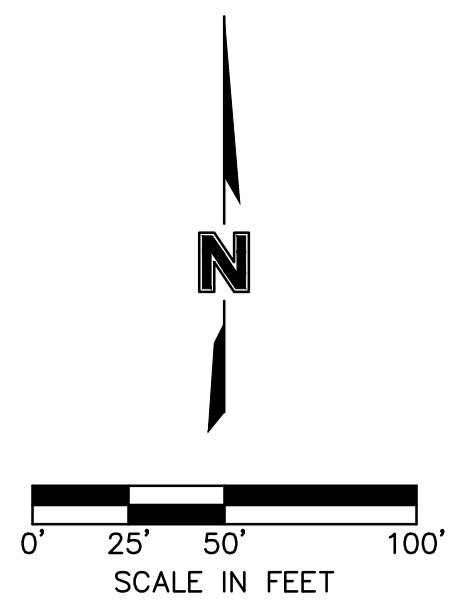
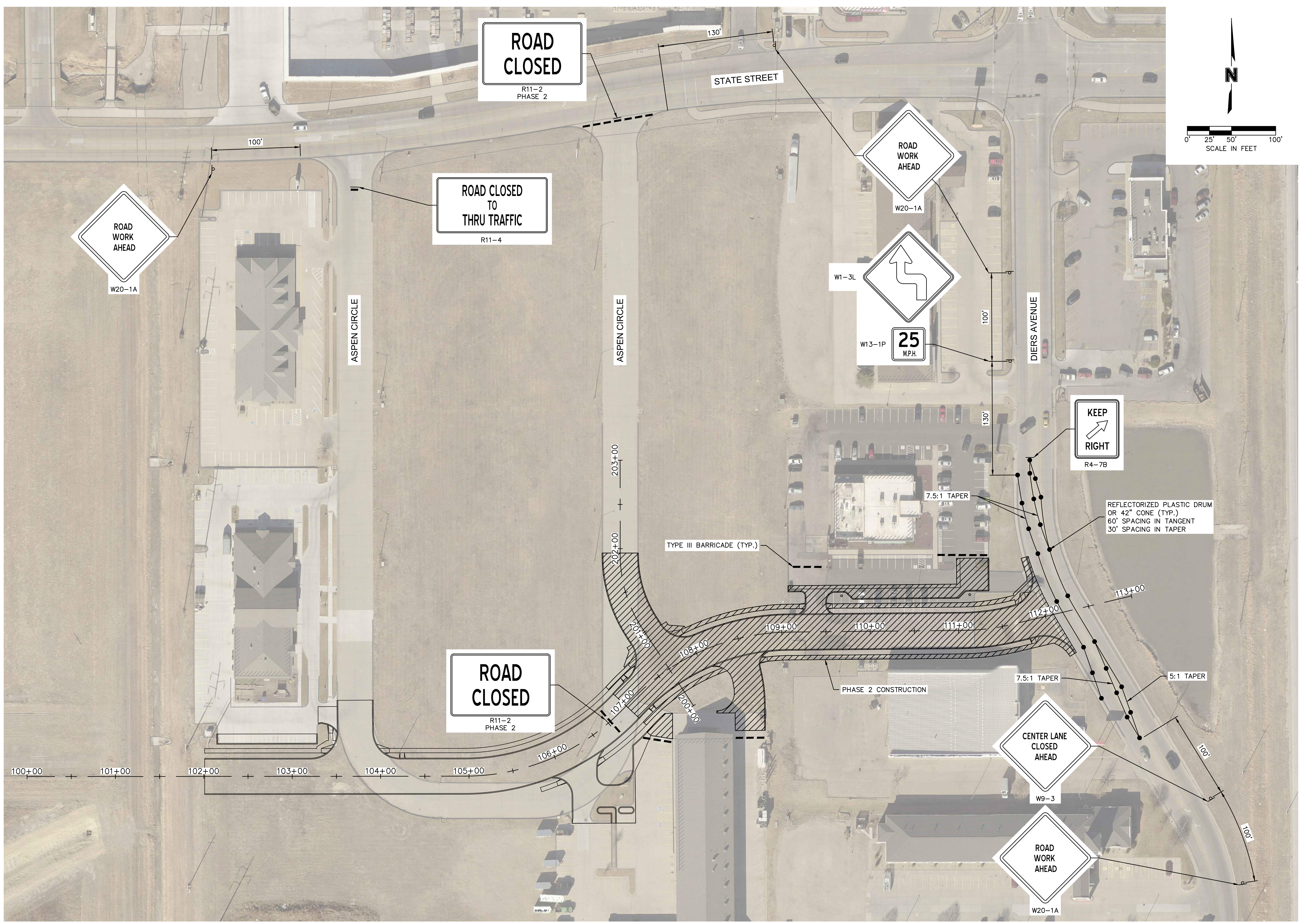

olsson
 201 East 2nd Street
 Grand Island, NE 68801 TEL 308.384.8750 www.olsson.com

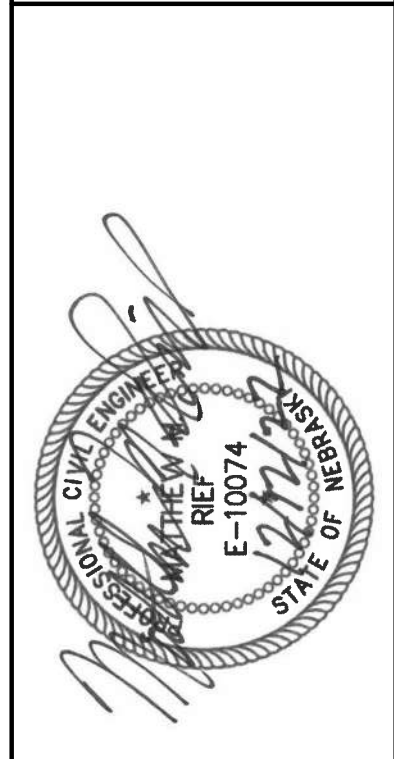

| REV. NO. | DATE | REVISIONS DESCRIPTION |
|----------|------|-----------------------|
| | | |
| | | |
| | | |

TEMPORARY TRAFFIC CONTROL PLAN - PHASE 2
 18TH STREET - MOORES CREEK TO DIERS AVENUE
 ROADWAY IMPROVEMENTS; PROJECT #2022-P-8
 GRAND ISLAND, NEBRASKA
 2022

drawn by: ZL
 checked by: ZL
 approved by: MMR
 project no.: 021-07494
 drawing no.:
 date:

DWG: F:\2021\07001-07500\021-07494\40-Design\AutoCAD\Final Plans\Sheets\GNCV\18th Street\18th St_02107494.dwg
 DATE: Dec 19, 2022 2:27pm XREFS: C_PBASE-Link_02107494 V_XTOPO_LDP_02107494 C_TTLBLK-18TH_02107494 C_AERL_02107494 USER: zloomis

| 01-18TH STREET | | | | | | | | | |
|----------------|-------------------|-------------------------------------|---|---|---------|--------------------|-----------|---------|---------|
| NO. | | STATION | NORTHING | EASTING | LENGTH | LINE/CHORD BEARING | DELTA | TANGENT | RADIUS |
| L1 | | 100+00.00 104+95.27 | 107454.8268 107455.3288 | 110735.1908 111230.4588 | 495.27' | N89°56'31"E | | | |
| C1 | PC= PI= PT= | 104+95.27 106+05.46 107+02.84 | 107455.3288 107455.4405 107536.8535 | 111230.4588 111340.6517 111414.9108 | 207.58' | N66°09'19"E | 47°34'23" | 110.19' | 250.00' |
| C2 | PC= PI= PT= | 107+02.84 108+11.84 109+08.41 | 107536.8535 107617.3825 107618.3681 | 111414.9108 111488.3637 111597.3558 | 205.57' | N65°55'31"E | 47°06'47" | 109.00' | 250.00' |
| L2 | | 109+08.41 111+04.55 | 107618.3681 107620.1415 | 111597.3558 111793.4802 | 196.13' | N89°28'55"E | | | |
| C3 | PC= PI= PT= | 111+04.55 111+32.79 111+60.79 | 107620.1415 107620.3969 107626.9456 | 111793.4802 111821.7200 111849.1913 | 56.24' | N83°02'13"E | 12°53'24" | 28.24' | 250.00' |
| L3 | | 111+60.79 113+00.00 | 107626.9456 107659.2264 | 111849.1913 111984.6063 | 139.21' | N76°35'31"E | | | |

| 02-ASPEN EAST | | | | | | | | | |
|---------------|-------------------|-------------------------------------|---|---|---------|--------------------|-----------|---------|---------|
| NO. | | STATION | NORTHING | EASTING | LENGTH | LINE/CHORD BEARING | DELTA | TANGENT | RADIUS |
| L4 | | 200+00.00 201+04.90 | 107535.0997 107622.5458 | 111489.1448 111431.2020 | 104.90' | N33°31'44"W | | | |
| C4 | PC= PI= PT= | 201+04.90 201+50.00 201+92.52 | 107622.5458 107660.1408 107705.2399 | 111431.2020 111406.2911 111406.2431 | 87.62' | N16°47'42"W | 33°28'05" | 45.10' | 150.00' |
| L5 | | 201+92.52 203+00.00 | 107705.2399 107812.7201 | 111406.2431 111406.1288 | 107.48' | N0°03'39"W | | | |

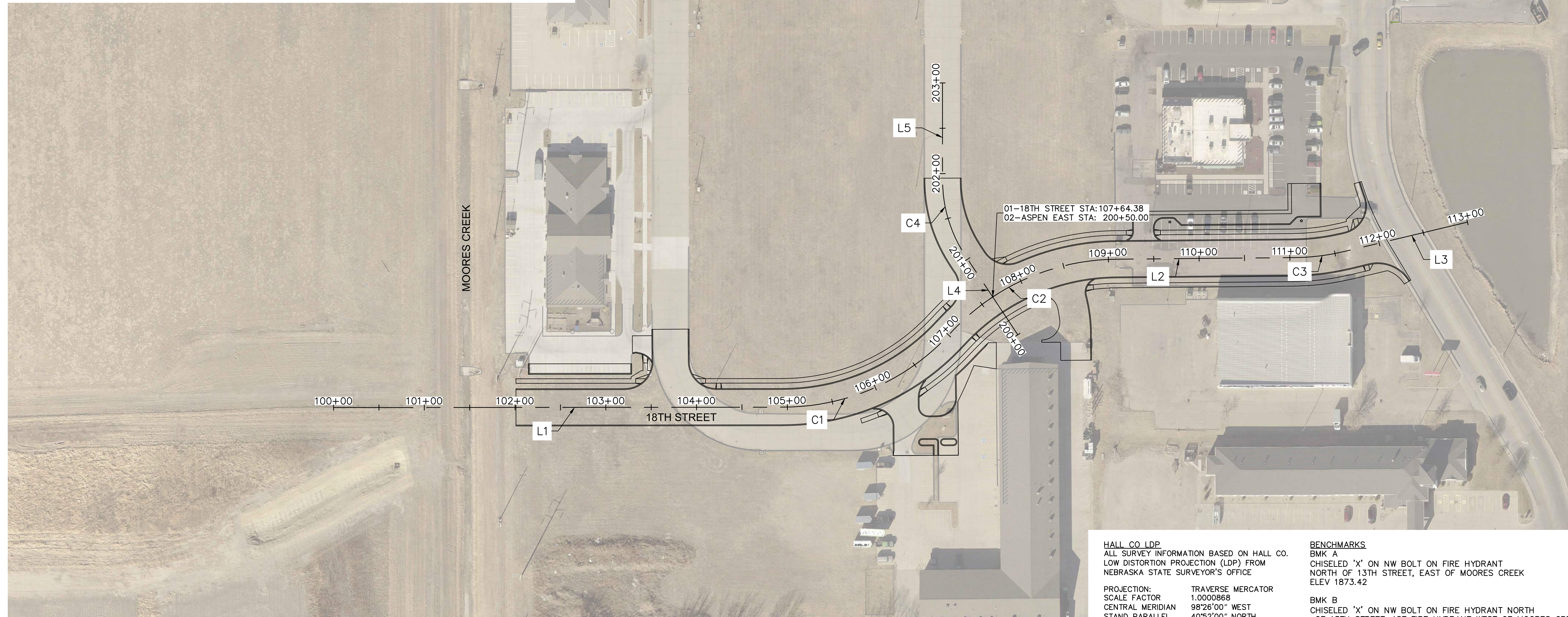

HALL CO LDP
 ALL SURVEY INFORMATION BASED ON HALL CO.
 LOW DISTORTION PROJECTION (LDP) FROM
 NEBRASKA STATE SURVEYOR'S OFFICE

PROJECTION: TRAVERSE MERCATOR
 SCALE FACTOR: 1.0000868
 CENTRAL MERIDIAN: 98°26'00" WEST
 STANDARD PARALLEL: 40°52'00" NORTH
 FALSE N/E: 25000/30000
 SPHEROID: GRS80
 DATUM: NAD 83
 VERTICAL DATUM: NAVD 88

BENCHMARKS
 BMK A
 CHISELED 'X' ON NW BOLT ON FIRE HYDRANT
 NORTH OF 13TH STREET, EAST OF MOORES CREEK
 ELEV 1873.42

BMK B
 CHISELED 'X' ON NW BOLT ON FIRE HYDRANT NORTH
 OF 13TH STREET, 1ST FIRE HYDRANT WEST OF MOORES CREEK
 ELEV 1876.07

BMK C
 CHISELED 'X' ON NW BOLT ON FIRE HYDRANT,
 NE CORNER OF MEADOW RD & SAGEWOOD AVE.
 ELEV 1876.39

olsson

201 East 2nd Street
 Grand Island, NE 68801 TEL 308.384.8750 www.olsson.com

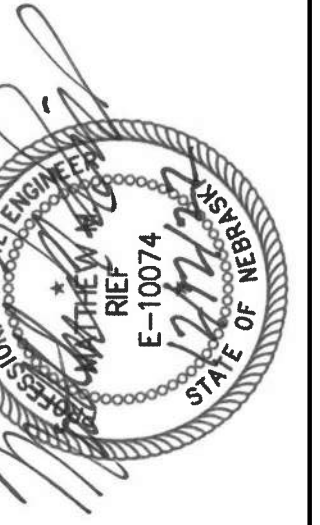

| REV. NO. | DATE | REVISIONS DESCRIPTION |
|----------|------|-----------------------|
| | | |
| | | |
| | | |
| | | |

HORIZONTAL AND VERTICAL CONTROL
 18TH STREET - MOORES CREEK TO DIERS AVENUE
 ROADWAY IMPROVEMENTS; PROJECT #2022-P-8
 GRAND ISLAND, NEBRASKA
 2022

drawn by: _____
 checked by: _____
 approved by: _____
 QA/QC by: _____
 project no.: 021-07494
 drawing no.: _____
 date: 12.19.2022

DWG: F:\2021\07001-07494\40-Design\AutoCAD\Final Plans\Sheets\GNCV\18th Street\C_COV-18TH St_02107494.dwg
 DATE: Dec 19, 2022 2:27pm
 USER: zloomis
 XREFS: C:\TTLB\K-18TH_02107494

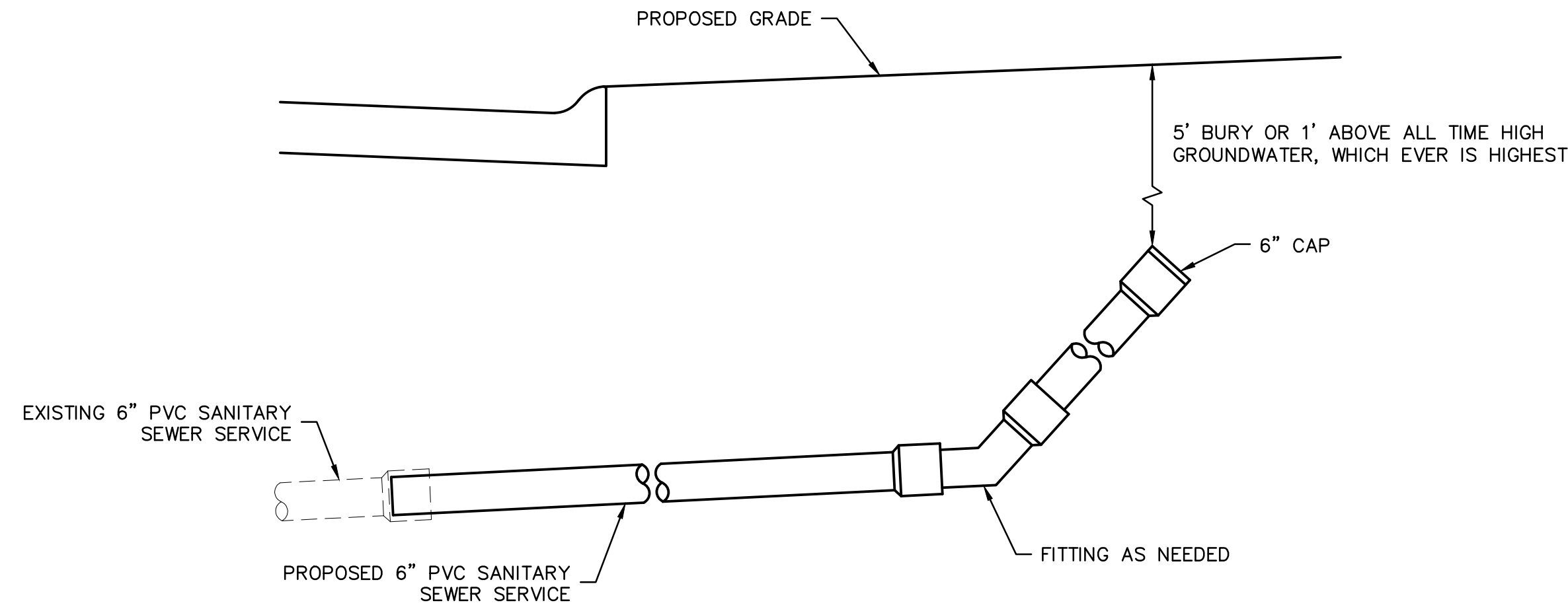

SANITARY SEWER SERVICE
NOT TO SCALE

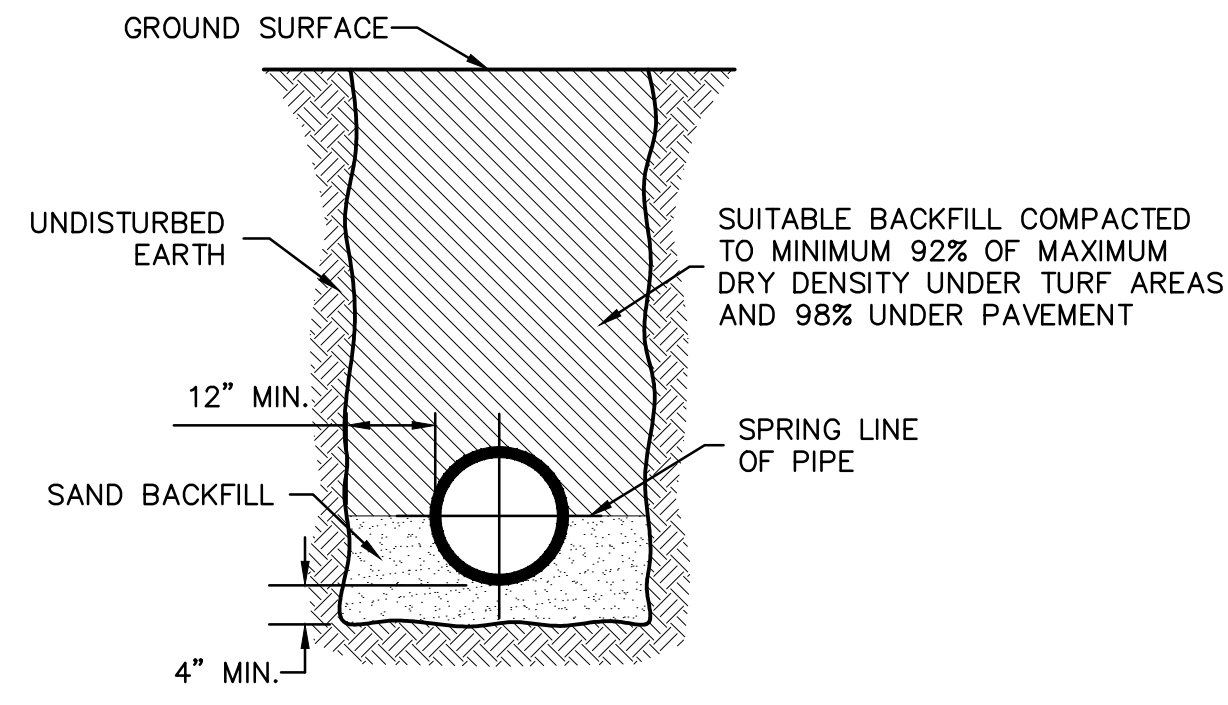

TRENCH BACKFILL
NOT TO SCALE

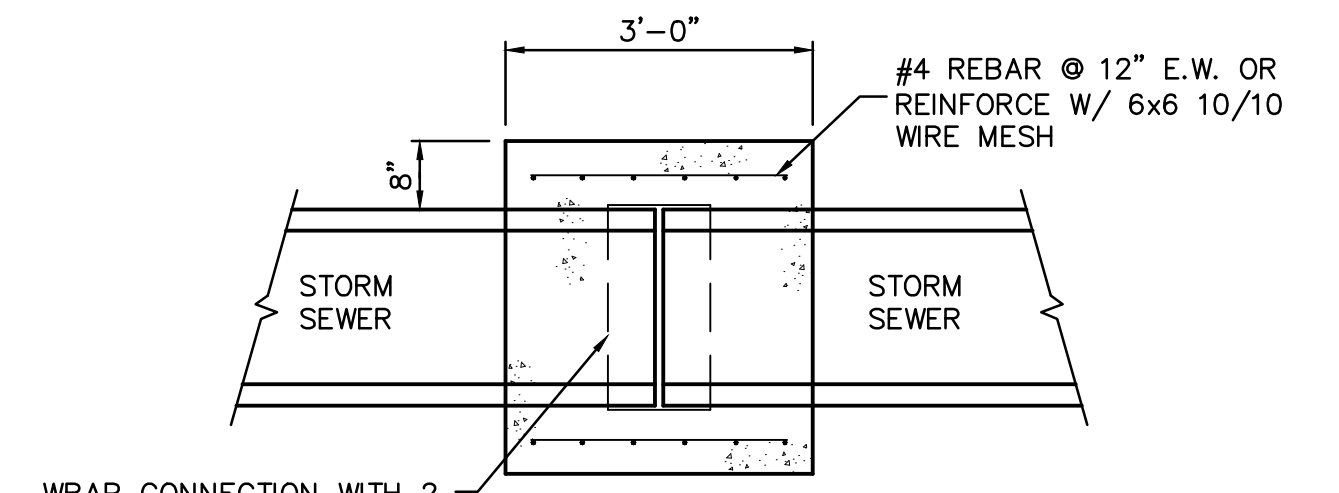

PIPE COLLAR DETAIL
NOT TO SCALE

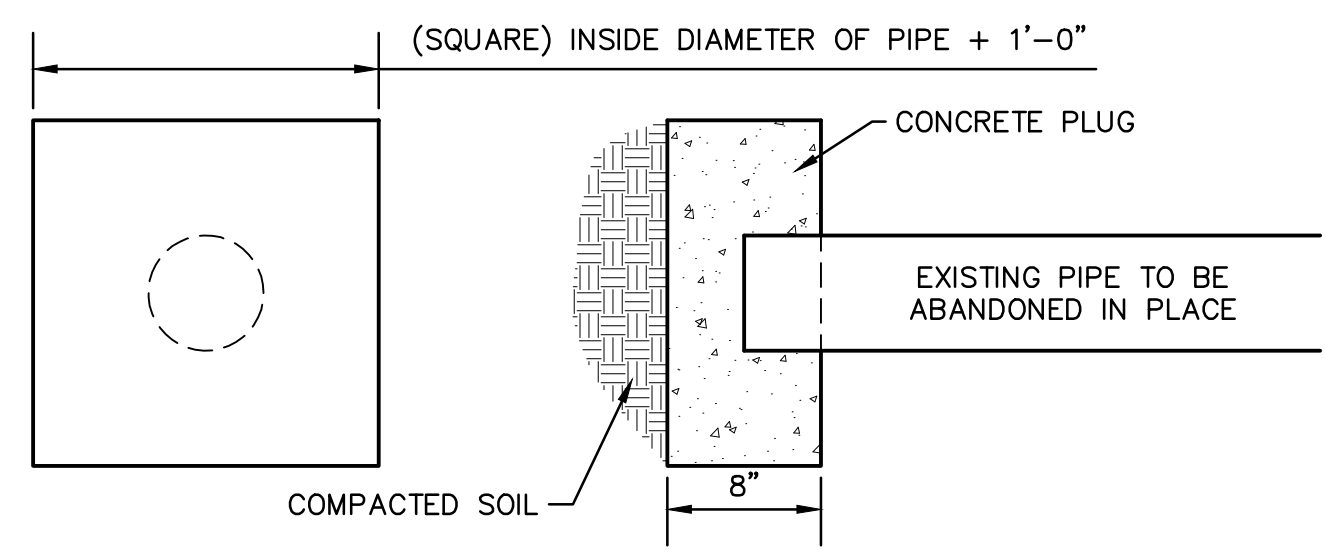

CONCRETE PLUG
NOT TO SCALE

- WATTLE NOTES:**
1. WATTLES SHALL EXTEND AN ADEQUATE DISTANCE TO PREVENT RUNOFF FROM FLOWING AROUND THE END OF THE BARRIER.
 2. TIGHTLY ABUT WATTLE ENDS TO PREVENT GAPS.
 3. WOOD STAKES SHALL BE PLACED AT 4' MAX. SPACING ALONG THE LENGTH OF WATTLES

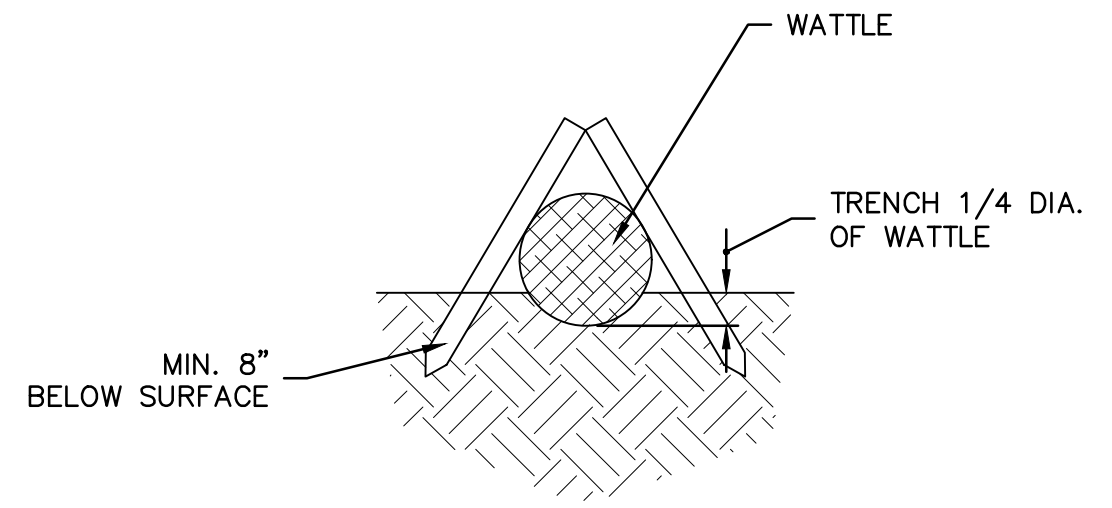

WATTLE DETAIL
NOT TO SCALE

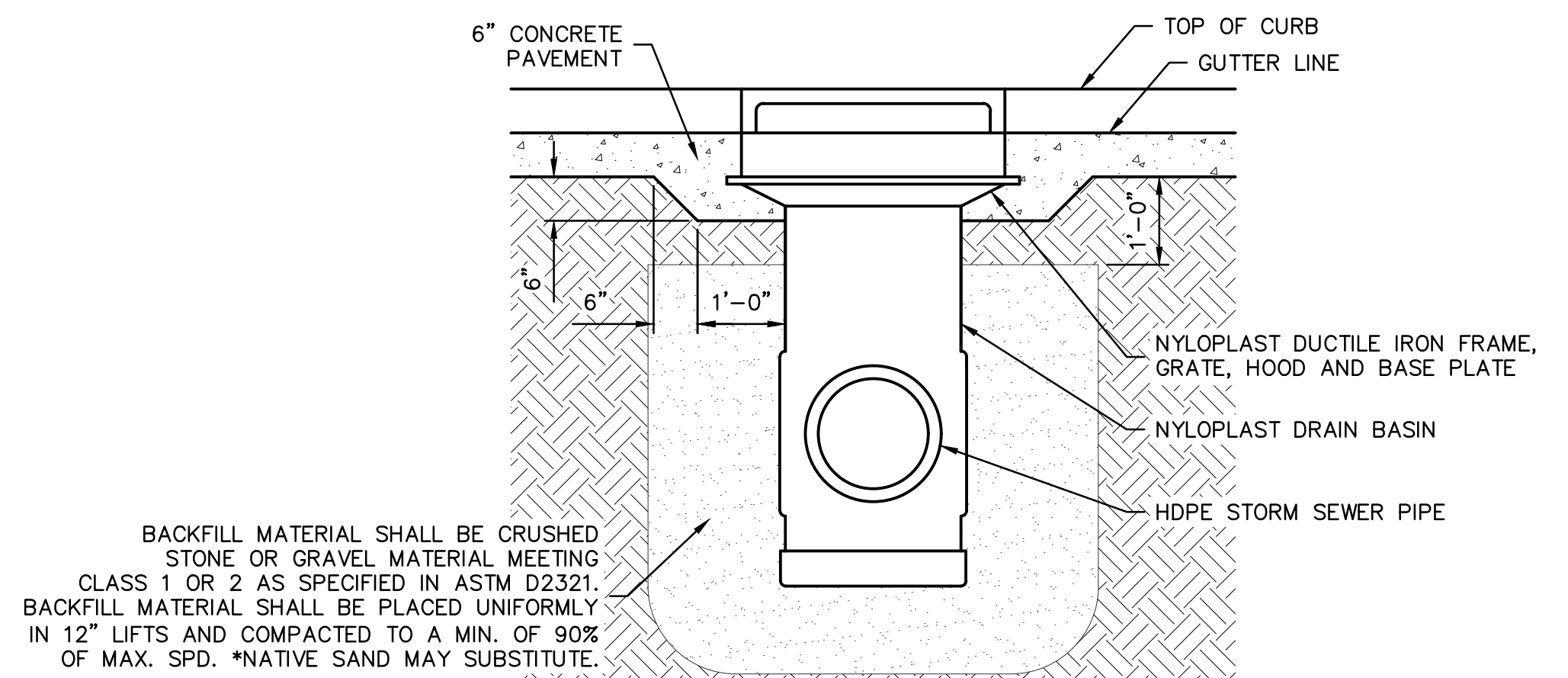

ALTERNATE PRIVATE CURB INLET DETAIL
NOT TO SCALE

- SILT FENCE NOTES**
1. SILT FENCE MAY ALSO BE INSTALLED WITH A SILT FENCE PLOW, NO PINNING IS REQUIRED WHEN THE SILT FENCE PLOW IS USED.
 2. FOR EACH STEEL STUDDED "T" LINE POST, 3 PLASTIC CABLE TIES ARE REQUIRED.
 3. SILT FENCE SHALL BE ON NDOR APPROVED PRODUCTS LIST.

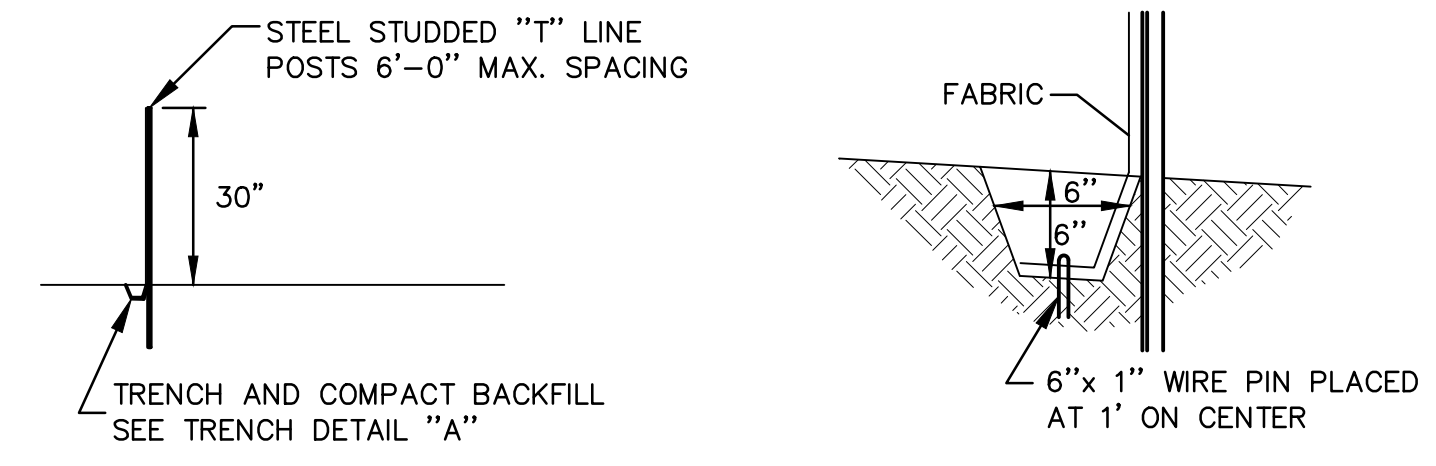

SILT FENCE DETAILS
NOT TO SCALE

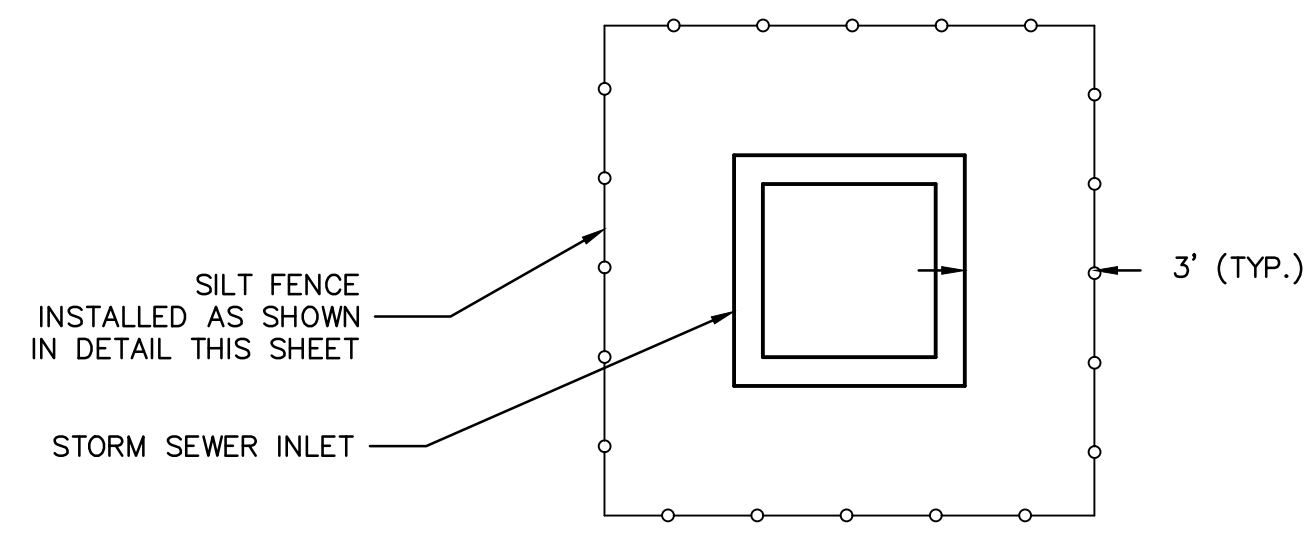

TEMPORARY INLET / MANHOLE PROTECTION
NOT TO SCALE

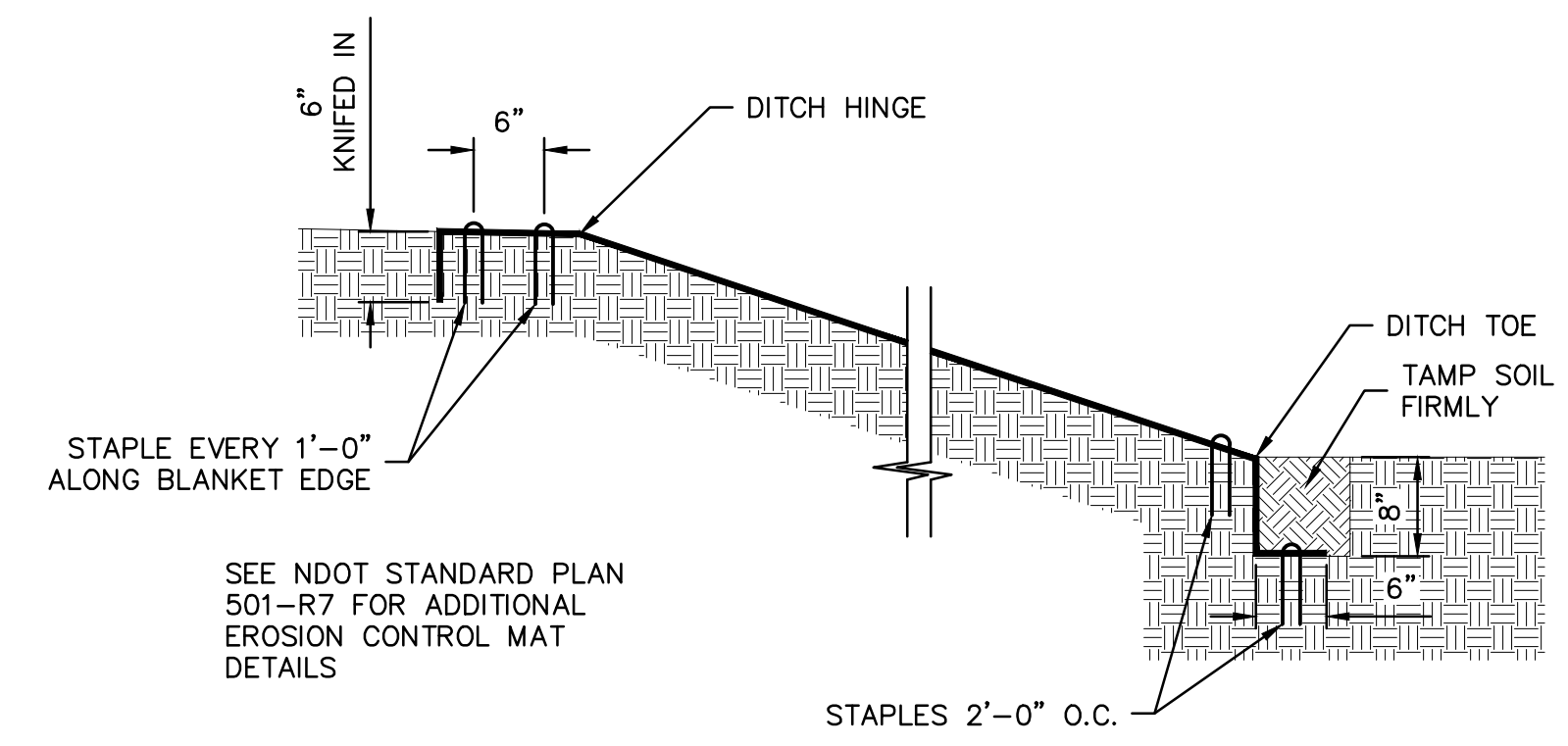

EROSION CONTROL MAT ANCHOR DETAIL
NOT TO SCALE

201 East 2nd Street
 Grand Island, NE 68801
 TEL 308.384.8750
 www.olsson.com

| REV. NO. | DATE | REVISIONS DESCRIPTION |
|----------|------|-----------------------|
| | | |
| | | |
| | | |
| | | |

GENERAL DETAILS

18TH STREET - MOORES CREEK TO DIERS AVENUE
ROADWAY IMPROVEMENTS; PROJECT #2022-P-8

GRAND ISLAND, NEBRASKA

2022

REVISIONS

drawn by: _____

checked by: _____

QA/QC by: _____

project no.: 021-07494

date: 12.19.2022

SHEET

11 of 35

DWG: F:\2021\07001-07500\021-07494\40-Design\AutoCAD\Final Plans\Sheets\GNCV\18th Street\18TH St_02107494.dwg
 DATE: Dec 19, 2022 2:27pm XREFS: V_XT050_LDP_02107494 C_PBASE-Link_02107494 C_PBASE-Claude_02107494
 USER: zloomis V_XRWAY_LDP_02107494 C_TTLBLK-18TH_02107494

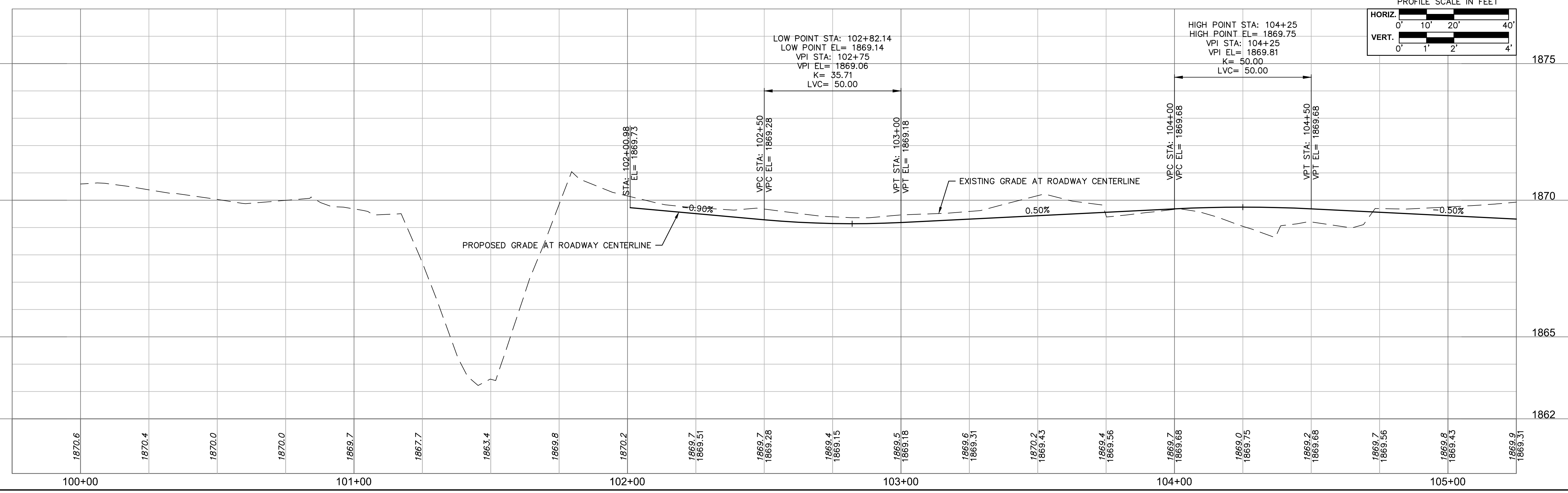
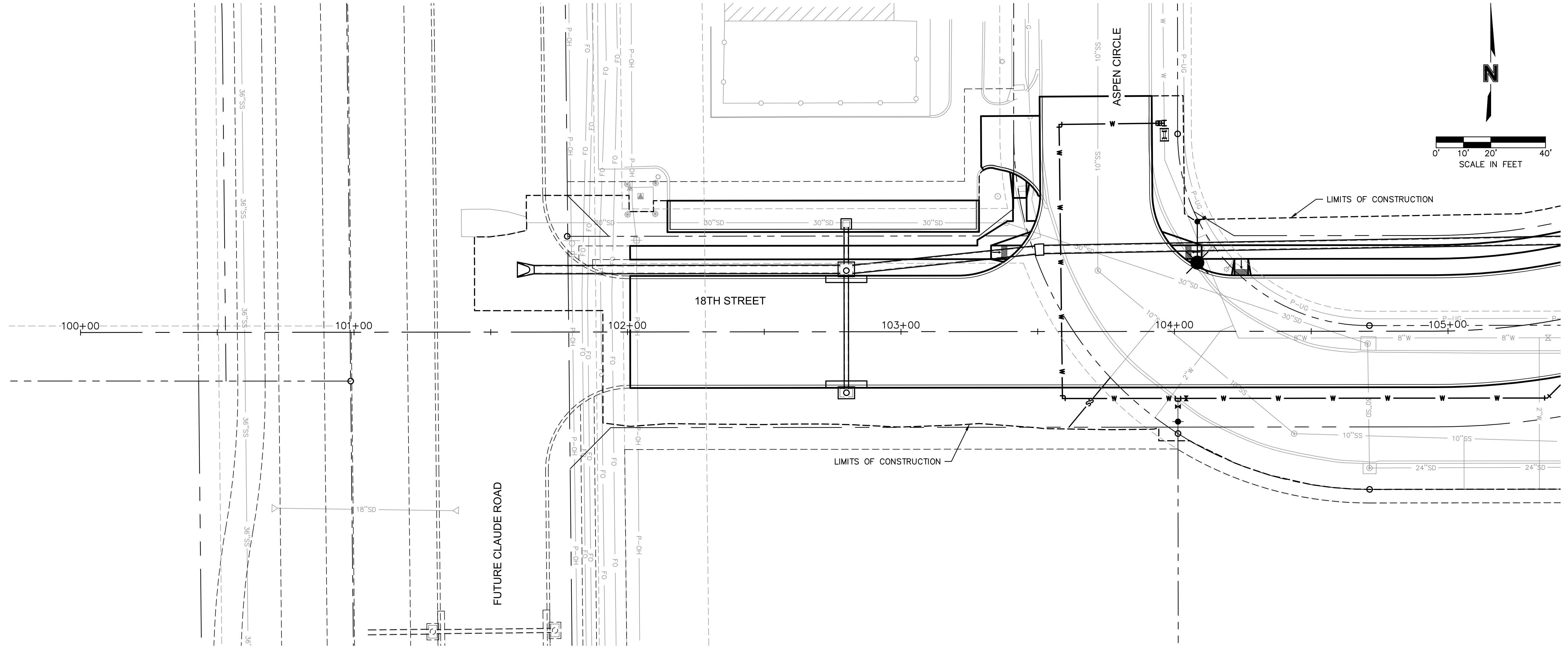

olsson

201 East 2nd Street
Grand Island, NE 68801 TEL 308.384.8750 www.olsson.com

| REV. NO. | DATE | REVISIONS DESCRIPTION |
|----------|------|-----------------------|
| | | |
| | | |
| | | |
| | | |

PLAN AND PROFILE
STA. 100+00 TO STA. 105+00

2022

18TH STREET - MOORES CREEK TO DIERS AVENUE
ROADWAY IMPROVEMENTS; PROJECT #2022-P-8

GRAND ISLAND, NEBRASKA

SHEET
12 of 35

drawn by: _____
 checked by: _____
 approved by: _____
 QA/QC by: _____
 project no.: 021-07494
 drawing no.: _____
 date: 12.12.2022

DWG: F:\2021\07001-07500\021-07494\40-Design\AutoCAD\Final Plans\Sheets\GNCV\18th Street\18th St_02107494.dwg
 DATE: Dec 19, 2022 2:28pm
 XREFS: V_XT050_LDP_02107494 C_PBASE-Link_02107494 C_PBASE-Claude_02107494
 USER: zloomis
 C_TTLBLK-18TH_02107494 V_XRWAY_LDP_02107494

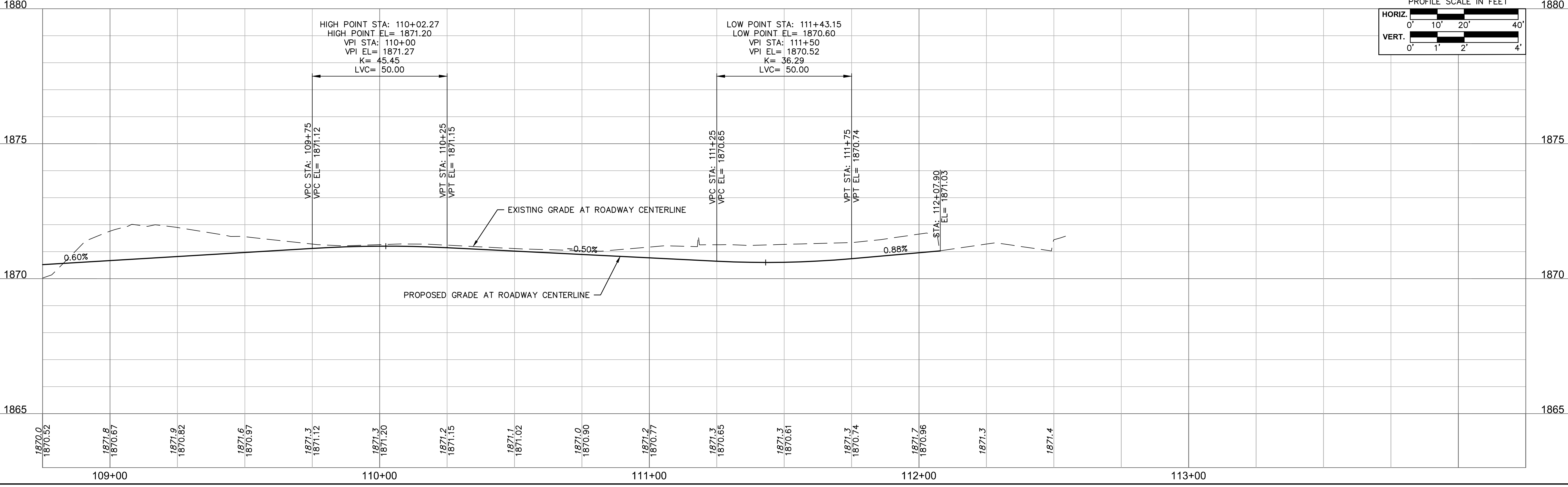
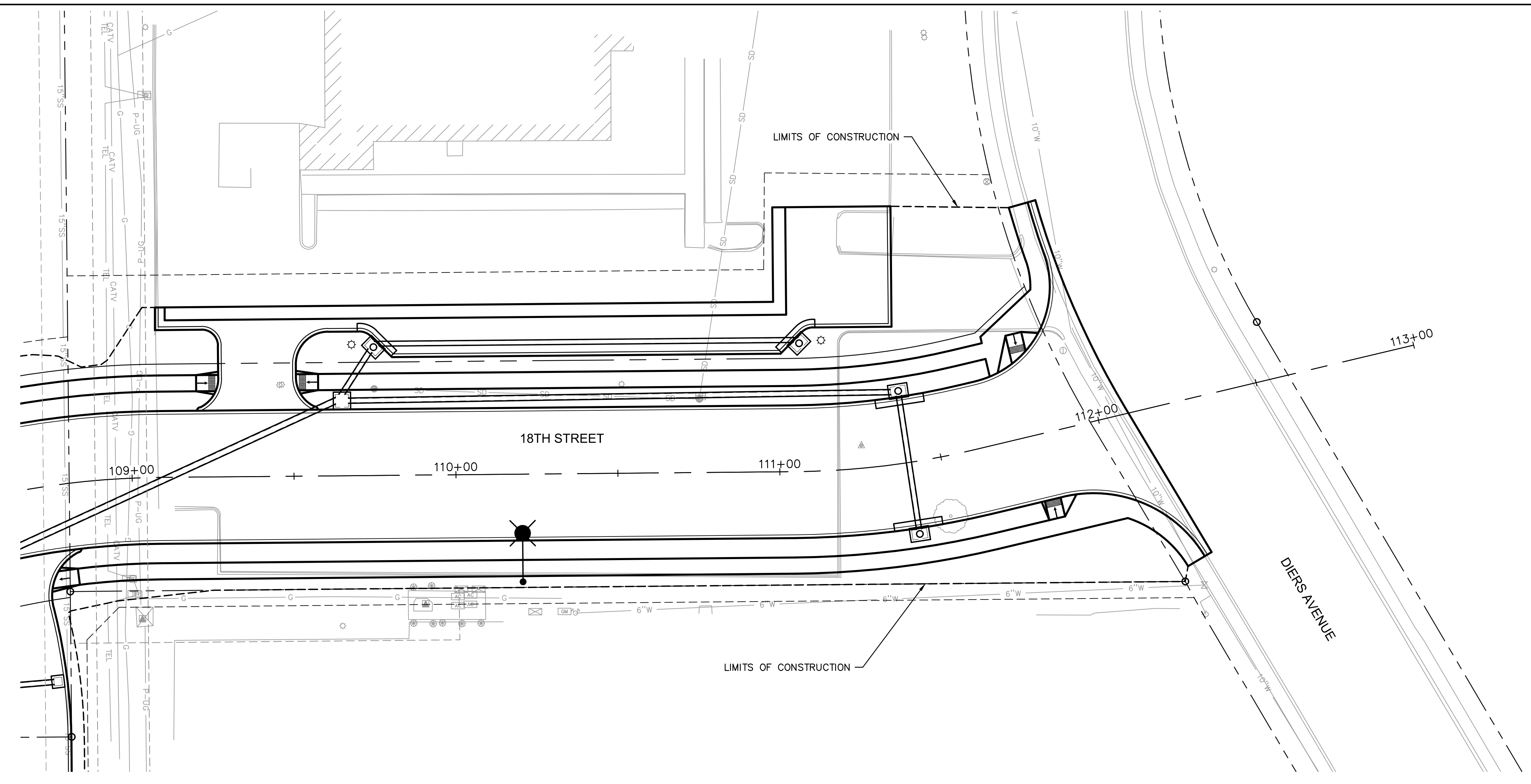

201 East 2nd Street
Grand Island, NE 68801 TEL 308.384.8750 www.olsson.com

| REV. NO. | DATE | REVISIONS DESCRIPTION |
|----------|------|-----------------------|
| | | |
| | | |
| | | |
| | | |

PLAN AND PROFILE
STA. 110+00 TO STA. 113+00

18TH STREET - MOORES CREEK TO DIERS AVENUE
ROADWAY IMPROVEMENTS; PROJECT #2022-P-8

GRAND ISLAND, NEBRASKA

2022

| | |
|--------------|------------|
| drawn by: | |
| checked by: | |
| approved by: | |
| QA/QC by: | |
| project no.: | 021-07494 |
| drawing no.: | |
| date: | 12.12.2022 |

SHEET
14 of 35

DWG: F:\2021\07001-07500\021-07494\40-Design\AutoCAD\Final Plans\Sheets\GNCV\18th Street\C_REM-18TH St_02107494.dwg
 DATE: Dec 19, 2022 2:28pm XREFS: V_XT050_LDP_02107494 C_PBASE-Link_02107494 C_TTLBLK-18TH_02107494 C_PBASE-Claude_02107494 V_XRWAY_LDP_02107494
 USER: zloomis C_PBASE-Claude_02107494

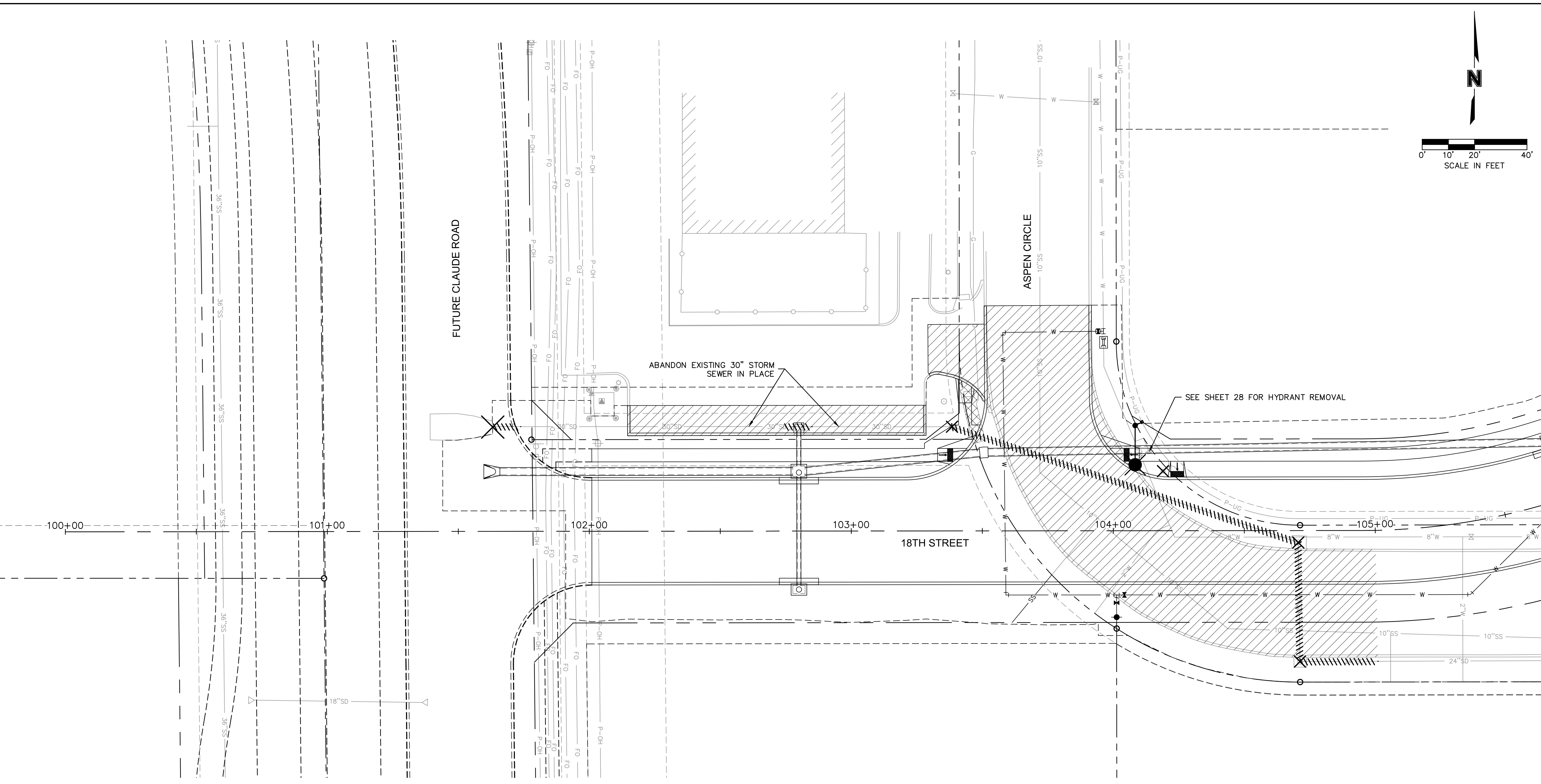

| REMOVE PAVEMENT | | |
|-----------------|-----------|----------|
| STA. TO STA. | SIDE | SQ. YDS. |
| 102+15 - 103+29 | LT. | 144 |
| 103+29 - 103+54 | LT. | 55 |
| 103+51 - 105+00 | LT. & RT. | 915 |

| REMOVE SIDEWALK | | |
|-----------------|------|----------|
| STA. TO STA. | SIDE | SQ. YDS. |
| 103+41 - 103+51 | LT. | 13 |

| REMOVE AND SALVAGE LIGHT POLE | | |
|-------------------------------|------|-----|
| STA. | SIDE | EA. |
| 104+19 | LT. | 1 |

| REMOVE STORM SEWER PIPE | | | |
|-------------------------|-----------|--|------|
| STA. TO STA. | SIDE | | L.F. |
| 101+64 - 101+74 | LT. | | 10 |
| 102+75 - 102+85 | LT. | | 10 |
| 103+38 - 104+71 | LT. & RT. | | 139 |
| 104+71 | RT. | | 45 |
| 104+71 - 105+00 | RT. | | 30 |

| REMOVE STORM SEWER MANHOLE | | |
|----------------------------|------|-----|
| STA. | SIDE | EA. |
| 103+38 | RT. | 1 |

| REMOVE STORM SEWER CURB INLET | | |
|-------------------------------|------|-----|
| STA. | SIDE | EA. |
| 104+71 | RT. | 1 |
| 104+71 | RT. | 1 |

| REMOVE FLARED END SECTION | | |
|---------------------------|------|-----|
| STA. | SIDE | EA. |
| 101+63 | LT. | 1 |

olsson

201 East 2nd Street
Grand Island, NE 68801 TEL 308.384.8750 www.olson.com

| REV. NO. | DATE | REVISIONS DESCRIPTION | REVISIONS |
|----------|------|-----------------------|-----------|
| | | | |
| | | | |
| | | | |
| | | | |
| | | | |

REMOVALS

STA. 100+00 TO STA. 105+00

18TH STREET - MOORES CREEK TO DIERS AVENUE
ROADWAY IMPROVEMENTS; PROJECT #2022-P-8

GRAND ISLAND, NEBRASKA

2022

drawn by: _____
 checked by: _____
 approved by: _____
 QA/QC by: _____
 project no.: 021-07494
 drawing no.: _____
 date: 10.17.2022

SHEET

16 of 35

DWG: F:\2021\07001-07500\021-07494\40-Design\AutoCAD\Final Plans\Sheets\GNCA\18th Street\18TH St_02107494.dwg
 DATE: Dec 19, 2022 2:28pm XREFS: V_XTOPO_LDP_02107494 C_PBASE-Link_02107494 C_PBASE-Link_02107494 C_TTLBLK-18TH_02107494
 USER: zloomis V_XRWAY_LDP_02107494 C_PBASE-Claude_02107494

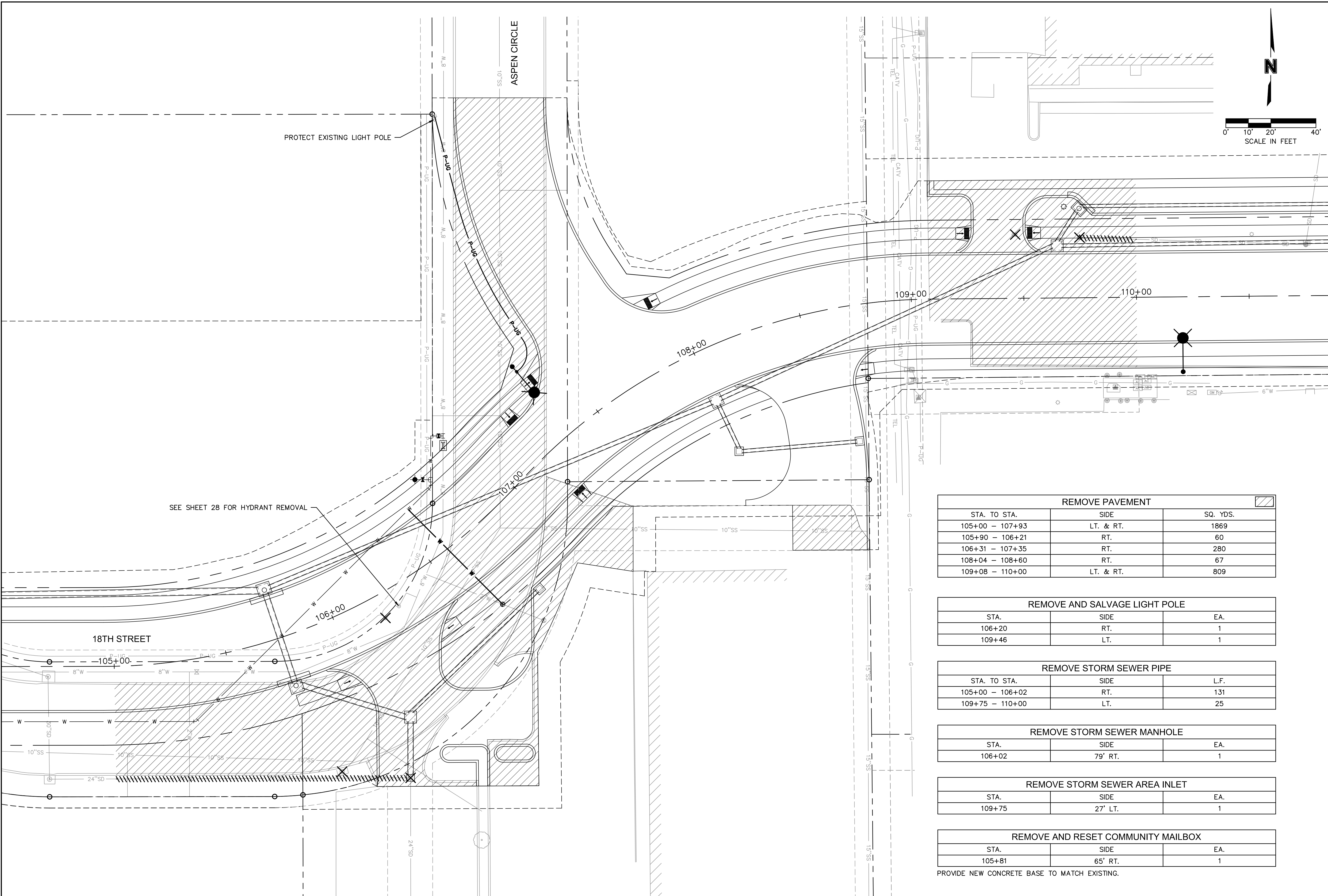

| REMOVE PAVEMENT | | |
|-----------------|-----------|----------|
| STA. TO STA. | SIDE | SQ. YDS. |
| 105+00 - 107+93 | LT. & RT. | 1869 |
| 105+90 - 106+21 | RT. | 60 |
| 106+31 - 107+35 | RT. | 280 |
| 108+04 - 108+60 | RT. | 67 |
| 109+08 - 110+00 | LT. & RT. | 809 |

| REMOVE AND SALVAGE LIGHT POLE | | |
|-------------------------------|------|-----|
| STA. | SIDE | EA. |
| 106+20 | RT. | 1 |
| 109+46 | LT. | 1 |

| REMOVE STORM SEWER PIPE | | |
|-------------------------|------|------|
| STA. TO STA. | SIDE | L.F. |
| 105+00 - 106+02 | RT. | 131 |
| 109+75 - 110+00 | LT. | 25 |

| REMOVE STORM SEWER MANHOLE | | |
|----------------------------|---------|-----|
| STA. | SIDE | EA. |
| 106+02 | 79' RT. | 1 |

| REMOVE STORM SEWER AREA INLET | | |
|-------------------------------|---------|-----|
| STA. | SIDE | EA. |
| 109+75 | 27' LT. | 1 |

| REMOVE AND RESET COMMUNITY MAILBOX | | |
|------------------------------------|---------|-----|
| STA. | SIDE | EA. |
| 105+81 | 65' RT. | 1 |

PROVIDE NEW CONCRETE BASE TO MATCH EXISTING.

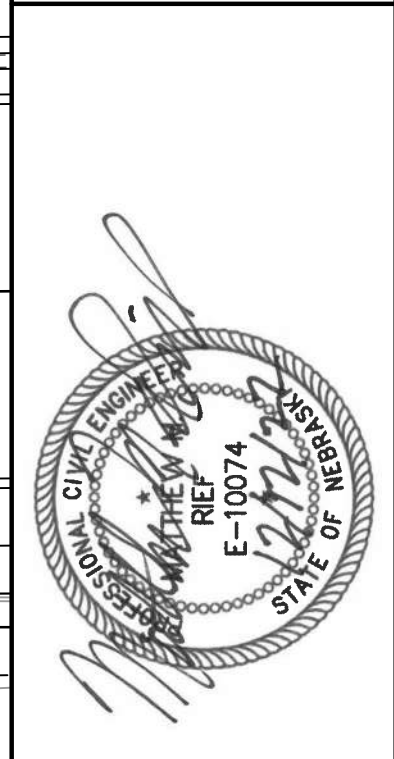

| REV. NO. | DATE | REVISIONS DESCRIPTION |
|----------|------|-----------------------|
| | | |
| | | |
| | | |
| | | |
| | | |

| REMOVALS | REVISIONS |
|--|-----------|
| STA. 105+00 TO STA. 110+00 | |
| 18TH STREET - MOORES CREEK TO DIERS AVENUE ROADWAY IMPROVEMENTS; PROJECT #2022-P-8 | |
| GRAND ISLAND, NEBRASKA | 2022 |

drawn by: _____
 checked by: _____
 approved by: _____
 QA/QC by: _____
 project no.: 021-07494
 drawing no.: _____
 date: 10.17.2022

DWG: F:\2021\07001-07500\021-07494\40-Design\AutoCAD\Final Plans\Sheets\GNCV\18th Street\C-CON-18TH St_02107494.dwg
 DATE: Dec 19, 2022 2:29pm
 USER: zloomis
 C_PBASE=Claude_02107494
 V_XRWAY_LDP_02107494

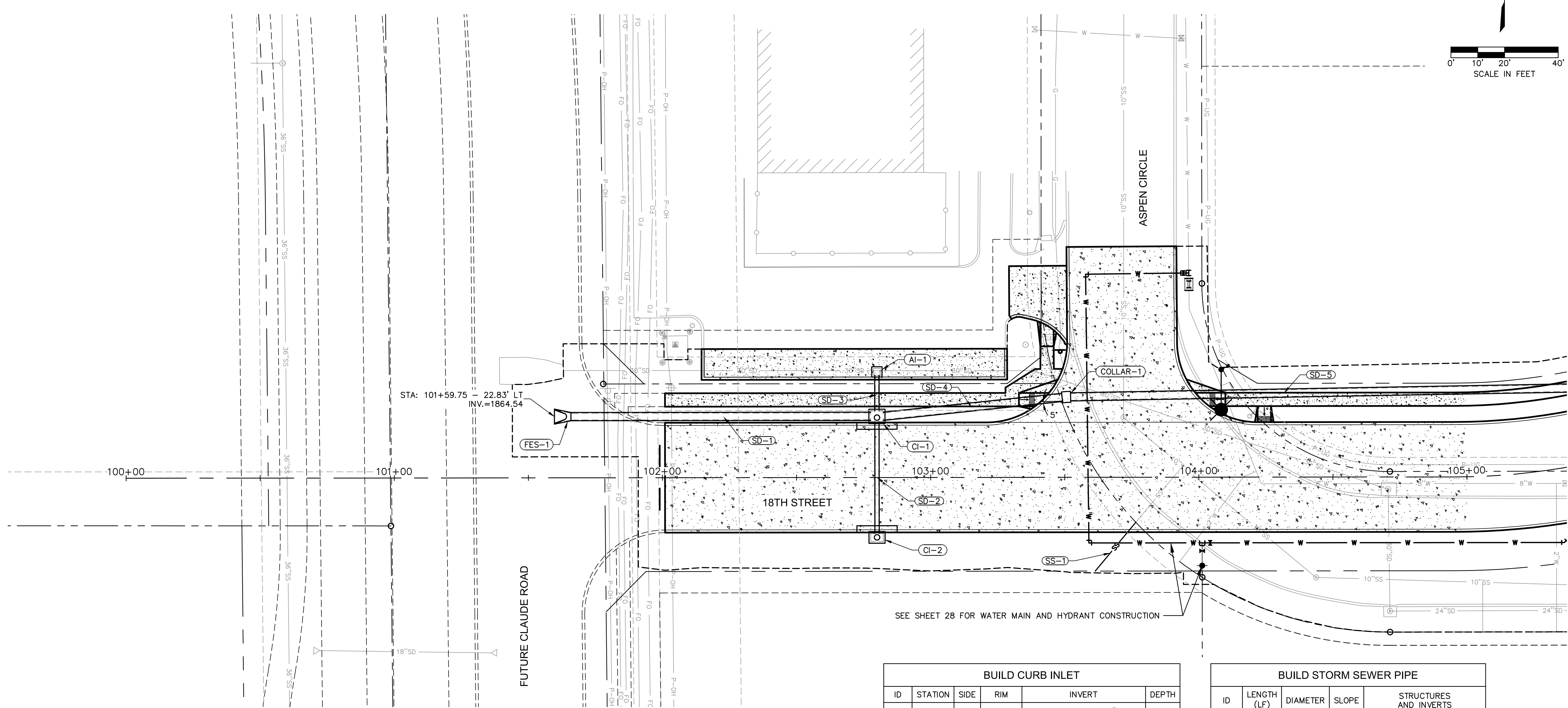

| BUILD 8" CONCRETE PAVEMENT | | |
|----------------------------|---------|------|
| STA. TO STA. | SIDE | SY |
| 102+01 - 105+00 | LT & RT | 1362 |
| 103+21 - 104+22 | LT | 342 |

| BUILD 6" CONCRETE PAVEMENT | | |
|----------------------------|------|-----|
| STA. TO STA. | SIDE | SY |
| 102+15 - 103+29 | LT | 146 |
| 103+39 - 103+52 | LT | 52 |

| BUILD 5" CONCRETE SIDEWALK | | |
|----------------------------|------|-----|
| STA. TO STA. | SIDE | SY |
| 102+01 - 103+52 | LT | 103 |
| 103+92 - 105+00 | LT | 62 |

| INSTALL STREET SIGN AND POST | | |
|------------------------------|---------|---|
| STA. | SIDE | SIGNS |
| 103+48 | 47' LT. | STOP (R1-1) STREET NAME, 18TH STREET (D3-1) STREET NAME, TBD (D3-1) |

SIGN POST SHALL BE TELESPAR, 2" SQUARE, 12" GAUGE INSTALLED USING A TELESPAR 12 GAUGE ANCHOR (2-1/4" OD X 36") OR APPROVED EQUAL. HARDWARE TO INSTALL SIGN ON POST IS SUBSIDIARY TO THIS ITEM. WASHERS SHALL BE USED ON BOTH SIDE OF SIGN.

| BUILD CURB RAMP | | |
|-----------------|------|---------------------|
| STA. | SIDE | WARNING PANELS (SF) |
| 103+33 | LT | 10 |
| 103+43 | LT. | - |
| 104+10 | LT | 10 |
| 104+24 | LT | 10 |

*CONCRETE CONSTRUCTION OF CURB RAMPS SHALL BE SUBSIDIARY TO CONCRETE SIDEWALK. DETECTABLE WARNING PANELS SHALL BE PAID FOR SEPARATELY.

| ADJUST MANHOLE TO GRADE | | | |
|-------------------------|---------|---------|---------|
| STA. | SIDE | EG EL | FG EL |
| 103+72 | 22' LT. | 1869.60 | 1869.17 |
| 104+44 | 37' RT. | 1869.14 | 1870.09 |

| INSTALL TYPE III BARRICADE WITH POSTS | | | |
|---------------------------------------|------|-----|--|
| STA. | SIDE | EA. | |
| 101+99 | LT. | 1 | |
| 101+99 | RT. | 1 | |

EACH TYPE III BARRICADE SHALL INCLUDE TWO SIGN POSTS. SIGN POST SHALL BE TELESPAR, 2" SQUARE, 12" GAUGE INSTALLED USING A TELESPAR 12 GAUGE ANCHOR (2-1/4" OD X 36") OR APPROVED EQUAL. HARDWARE TO INSTALL SIGN ON POST IS SUBSIDIARY TO THIS ITEM. WASHERS SHALL BE USED ON BOTH SIDE OF SIGN.

| BUILD CURB INLET | | | | | |
|------------------|---------|------|---------|---|-------|
| ID | STATION | SIDE | RIM | INVERT | DEPTH |
| CI-1 | 102+80 | LT | 1869.23 | IN INV.=1864.72 30" RCP IN INV.=1864.91 15" RCP OUT INV.=1864.72 30" RCP IN INV.=1864.91 15" RCP | 4.51 |
| CI-2 | 102+80 | RT | 1869.23 | OUT INV.=1865.73 15" RCP | 3.50 |

| BUILD AREA INLET | | | | | |
|------------------|---------|----------|---------|--------------------------|-------|
| ID | STATION | SIDE | RIM | INVERT | DEPTH |
| * AI-1 | 102+80 | 39.4' LT | 1870.15 | OUT INV.=1866.15 15" RCP | 4.00 |

*NYLOPLAST CURB INLET IS AN ACCEPTABLE ALTERNATIVE.

| BUILD CONCRETE COLLAR | | | |
|-----------------------|---------|----------|----------------------|
| ID | STATION | SIDE | INVERT |
| COLLAR-1 | 103+51 | 30.0' LT | INV.=1864.83 30" RCP |

| 6" SANITARY SEWER SERVICE | | | | | | |
|---------------------------|-------------|-------|------------------------------|------------------|---------------------------|---------------|
| ID | LENGTH (LF) | SLOPE | BEGINNING STATION AND OFFSET | BEGINNING INVERT | ENDING STATION AND OFFSET | ENDING INVERT |
| SS-1 | 24 | 1.00% | 103+76.5' - 16.8 RT | 1863.61 | 103+61.3 - 35.0' RT | 1863.85 |

6" SANITARY SEWER SERVICE SHALL INCLUDE REMOVAL OF EXISTING CAP, CONNECTION TO EXISTING SERVICE, 6" PVC SERVICE LINE AND 6" PVC CAP

| BUILD STORM SEWER PIPE | | | | |
|------------------------|-------------|----------|-------|--|
| ID | LENGTH (LF) | DIAMETER | SLOPE | STRUCTURES AND INVERTS |
| SD-1 | 114 | 30" RCP | 0.15% | START: FES-1 1864.55 END: CI-1 1864.72 |
| SD-2 | 45 | 15" RCP | 1.84% | START: CI-1 1864.91 END: CI-2 1865.73 |
| SD-3 | 17 | 15" RCP | 7.26% | START: CI-1 1864.91 END: AI-1 1866.15 |
| SD-4 | 71 | 30" RCP | 0.15% | START: CI-1 1864.72 END: COLLAR-1 1864.83 |
| SD-5 | 216 | 30" RCP | 0.15% | START: COLLAR-1 1864.83 END: CI-3 1865.15 |

| BUILD FLARED END SECTION | | | | |
|--------------------------|---------|---------|----------|--------------|
| ID | STATION | SIDE | DIAMETER | INVERT |
| FES-1 | 101+66 | 22.8 LT | 30" RC | INV.=1864.55 |

olsson
 201 East 2nd Street
 Grand Island, NE 68801 TEL 308.384.8750 www.olsoson.com

| REV. NO. | DATE | REVISIONS DESCRIPTION |
|----------|------|-----------------------|
| | | |
| | | |

CONSTRUCTION
 STA. 100+00 TO STA. 105+00
 18TH STREET - MOORES CREEK TO DIERS AVENUE
 ROADWAY IMPROVEMENTS; PROJECT #2022-P-8
 GRAND ISLAND, NEBRASKA

drawn by: _____
 checked by: _____
 approved by: _____
 QA/QC by: _____
 project no.: 021-07494
 drawing no.: _____
 date: 11.10.2022

DWG: F:\2021\07001-07500\021-07494\40-Design\AutoCAD\Final Plans\Sheets\GNCV\18th Street\C_CON-18TH St_02107494.dwg
 DATE: Dec 19, 2022 2:29pm
 USER: zoomis
 C:\PBASE-Cloud_02107494
 V_XRWAY_LDP_02107494
 XREFS: V_XT050_LDP_02107494 C_PBASE-Link_02107494 C_TLBLK-18TH_02107494 C_PBASE-Link_02107494

| BUILD 8" CONCRETE PAVEMENT | | |
|----------------------------|---------|------|
| STA. TO STA. | SIDE | SY |
| 105+00 - 110+00 | LT & RT | 2278 |
| 200+71 - 201+95 | LT & RT | 599 |

| BUILD 7" CONCRETE PAVEMENT | | |
|----------------------------|------|-----|
| STA. TO STA. | SIDE | SY |
| 105+88 - 107+34 | RT | 550 |
| 108+22 - 108+63 | RT | 357 |

| BUILD 6" CONCRETE PAVEMENT | | |
|----------------------------|------|-----|
| STA. TO STA. | SIDE | SY |
| 109+08 - 110+00 | LT | 173 |

| BUILD 5" CONCRETE SIDEWALK | | |
|----------------------------|------|-----|
| STA. TO STA. | SIDE | SY |
| 105+00 - 107+47 | LT | 130 |
| 105+74 - 106+00 | RT | 16 |
| 106+35 - 108+26 | RT | 105 |
| 107+82 - 109+27 | LT | 88 |
| 108+70 - 110+00 | RT | 70 |
| 109+51 - 110+00 | LT | 28 |

| BUILD CURB RAMP | | |
|-----------------|------|---------------------|
| STA. | SIDE | WARNING PANELS (SF) |
| 105+91 | RT | - |
| 106+46 | RT | - |
| 107+20 | RT | 10 |
| 108+80 | RT | - |
| 107+20 | LT | 10 |
| 107+32 | LT | 10 |
| 107+96 | LT | 10 |
| 109+20 | LT | 10 |
| 109+58 | LT | 10 |

*CONCRETE CONSTRUCTION OF CURB RAMPS SHALL BE SUBSIDIARY TO CONCRETE SIDEWALK. DETECTABLE WARNING PANELS SHALL BE PAID FOR SEPARATELY.

| PARKING LOT PAVEMENT MARKING | | | |
|------------------------------|------|--|------|
| STA. TO STA. | SIDE | | L.S. |
| 109+08 - 111+49 | LT. | | 1 |

PARKING LOT PAVEMENT MARKINGS SHALL BE 4" WHITE PAINT.

SEE SHEET 28 FOR WATER MAIN AND HYDRANT CONSTRUCTION

| INSTALL STREET SIGN AND POST | | |
|------------------------------|---------|---|
| STA. | SIDE | SIGNS |
| 107+40 | 45' LT. | STOP (R1-1) STREET NAME, 18TH STREET (D3-1) STREET NAME, TBD (D3-1) |

SIGN POST SHALL BE TELESAR, 2" SQUARE, 12" GAUGE INSTALLED USING A TELESAR 12 GAUGE ANCHOR (2-1/4" OD X 36") OR APPROVED EQUAL. HARDWARE TO INSTALL SIGN ON POST IS SUBSIDIARY TO THIS ITEM. WASHERS SHALL BE USED ON BOTH SIDE OF SIGN.

| BUILD CURB INLET | | | | | |
|------------------|---------|------|---------|--|-------|
| ID | STATION | SIDE | RIM | INVERT | DEPTH |
| CI-3 | 105+75 | LT | 1869.21 | IN INV.=1865.15 24" RCP OUT INV.=1865.15 30" RCP IN INV.=1865.15 18" RCP | 4.06 |
| CI-4 | 105+75 | RT | 1869.21 | OUT INV.=1865.24 24" RCP IN INV.=1865.24 24" RCP | 3.97 |
| * CI-7 | 109+75 | LT | 1871.40 | OUT INV.=1867.15 15" RCP IN INV.=1867.15 15" RCP | 4.25 |

*NYLOPLAST CURB INLET IS AN ACCEPTABLE ALTERNATIVE.

| BUILD STORM SEWER MANHOLE | | | | | |
|---------------------------|---------|----------|---------|--|-------|
| ID | STATION | SIDE | RIM | INVERT | DEPTH |
| MH-1 | 106+11 | 54.8' RT | 1869.42 | OUT INV.=1865.48 24" RCP IN INV.=1865.48 15" RCP IN INV.=1865.48 24" RCP | 3.94 |
| MH-2 | 108+00 | 23.2' RT | 1870.16 | IN INV.=1865.80 18" RCP OUT INV.=1865.80 18" RCP IN INV.=1865.80 15" RCP | 4.36 |
| MH-3 | 109+65 | 23.2' LT | 1871.15 | OUT INV.=1866.46 18" RCP IN INV.=1866.46 15" RCP IN INV.=1866.46 15" RCP | 4.69 |

| BUILD AREA INLET | | | | | |
|------------------|---------|----------|---------|---|-------|
| ID | STATION | SIDE | RIM | INVERT | DEPTH |
| * AI-2 | 106+78 | 39.9' RT | 1869.73 | OUT INV.=1865.98 15" RCP | 3.75 |
| AI-3 | 107+99 | 47.8' RT | 1869.00 | OUT INV.=1866.00 15" RCP IN INV.=1866.00 15" RCP | 3.00 |
| * AI-4 | 108+66 | 60.1' RT | 1869.30 | OUT INV.=1866.30 15" RCP | 3.00 |

*NYLOPLAST CURB INLET IS AN ACCEPTABLE ALTERNATIVE.

| BUILD CONCRETE COLLAR | | | |
|-----------------------|---------|----------|----------------------|
| ID | STATION | SIDE | INVERT |
| COLLAR-2 | 106+02 | 79.1' RT | INV.=1865.60 24" RCP |

| BUILD STORM SEWER PIPE | | | | |
|------------------------|-------------|----------|-------|--|
| ID | LENGTH (LF) | DIAMETER | SLOPE | STRUCTURES AND INVERTS |
| SD-6 | 45 | 24" RCP | 0.20% | START: CI-3 1865.15 END: CI-4 1865.24 |
| SD-7 | 53 | 24" RCP | 0.45% | START: CI-4 1865.24 END: MH-1 1865.48 |
| SD-8 | 27 | 24" RCP | 0.45% | START: MH-1 1865.48 END: COLLAR-2 1865.60 |
| SD-9 | 81 | 15" RCP | 0.62% | START: MH-1 1865.48 END: AI-2 1865.98 |
| SD-10 | 218 | 18" RCP | 0.30% | START: CI-3 1865.15 END: MH-2 1865.80 |
| SD-11 | 166 | 18" RCP | 0.40% | START: MH-2 1865.80 END: MH-3 1866.46 |
| SD-12 | 25 | 15" RCP | 0.81% | START: MH-2 1865.80 END: AI-3 1866.00 |
| SD-13 | 54 | 15" RCP | 0.56% | START: AI-3 1866.00 END: AI-4 1866.30 |
| SD-16 | 19 | 15" RCP | 3.60% | START: MH-3 1866.46 END: CI-7 1867.15 |

| ADJUST MANHOLE TO GRADE | | | |
|-------------------------|----------|---------|---------|
| STA. | SIDE | EG EL | FG EL |
| 105+86 | 63' RT | 1869.35 | 1869.68 |
| 108+60 | 100' RT. | 1869.94 | 1869.62 |

RESET PARKING LOT LIGHT POLE
 STA. 109+68 SIDE 40.5' LT.
 PROVIDE NEW CONCRETE BASE TO MATCH EXISTING. INTERCEPT EXISTING CIRCUIT AND EXTEND TO NEW POLE LOCATIONS. CONNECT TO EXISTING CIRCUITING.

| RECONSTRUCT MANHOLE | | | |
|---------------------|-------|---------|---------|
| STA. | SIDE | EG EL | FG EL |
| 106+83 | 8' RT | 1870.16 | 1869.38 |

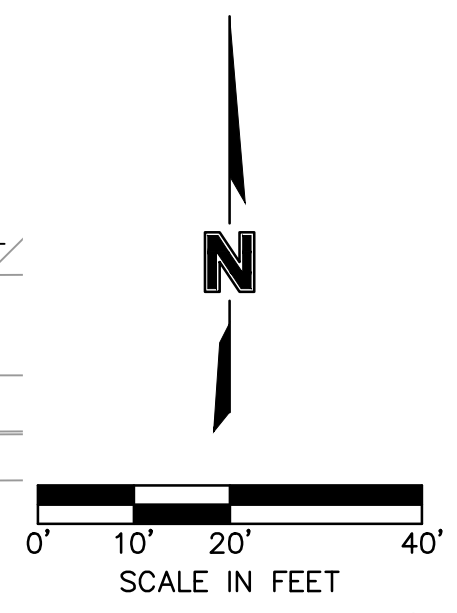
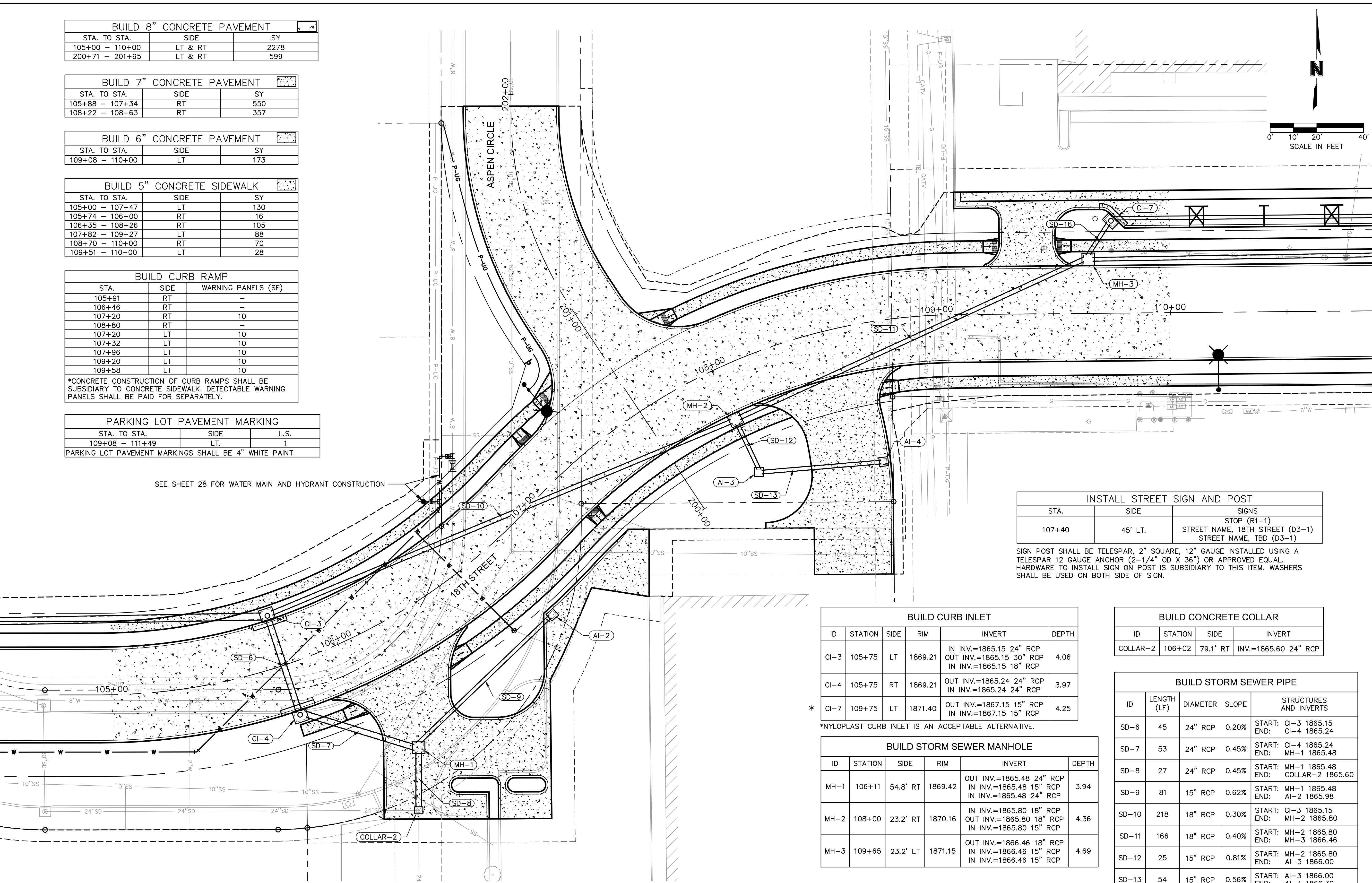

olsson
 201 East 2nd Street
 Grand Island, NE 68801
 TEL 308.384.8750
 www.olsson.com

| REV. NO. | DATE | REVISIONS DESCRIPTION |
|----------|------|-----------------------|
| | | |
| | | |
| | | |

CONSTRUCTION STA. 105+00 TO STA. 110+00
 18TH STREET - MOORES CREEK TO DIERS AVENUE
 ROADWAY IMPROVEMENTS; PROJECT #2022-P-8
 GRAND ISLAND, NEBRASKA
 2022

drawn by: _____
 checked by: _____
 approved by: _____
 QA/QC by: _____
 project no.: 021-07494
 drawing no.: _____
 date: 11.10.2022

SHEET 20 of 35

DWG: F:\2021\07001-07500\021-07494\40-Design\AutoCAD\Final Plans\Sheets\GNV\18th Street\C_GEO-18TH St_02107494.dwg
 DATE: Dec 19, 2022 2:29pm XREFS: C_PBASE-Link_02107494 C_TLBLK-18TH_02107494 USER: zoomis

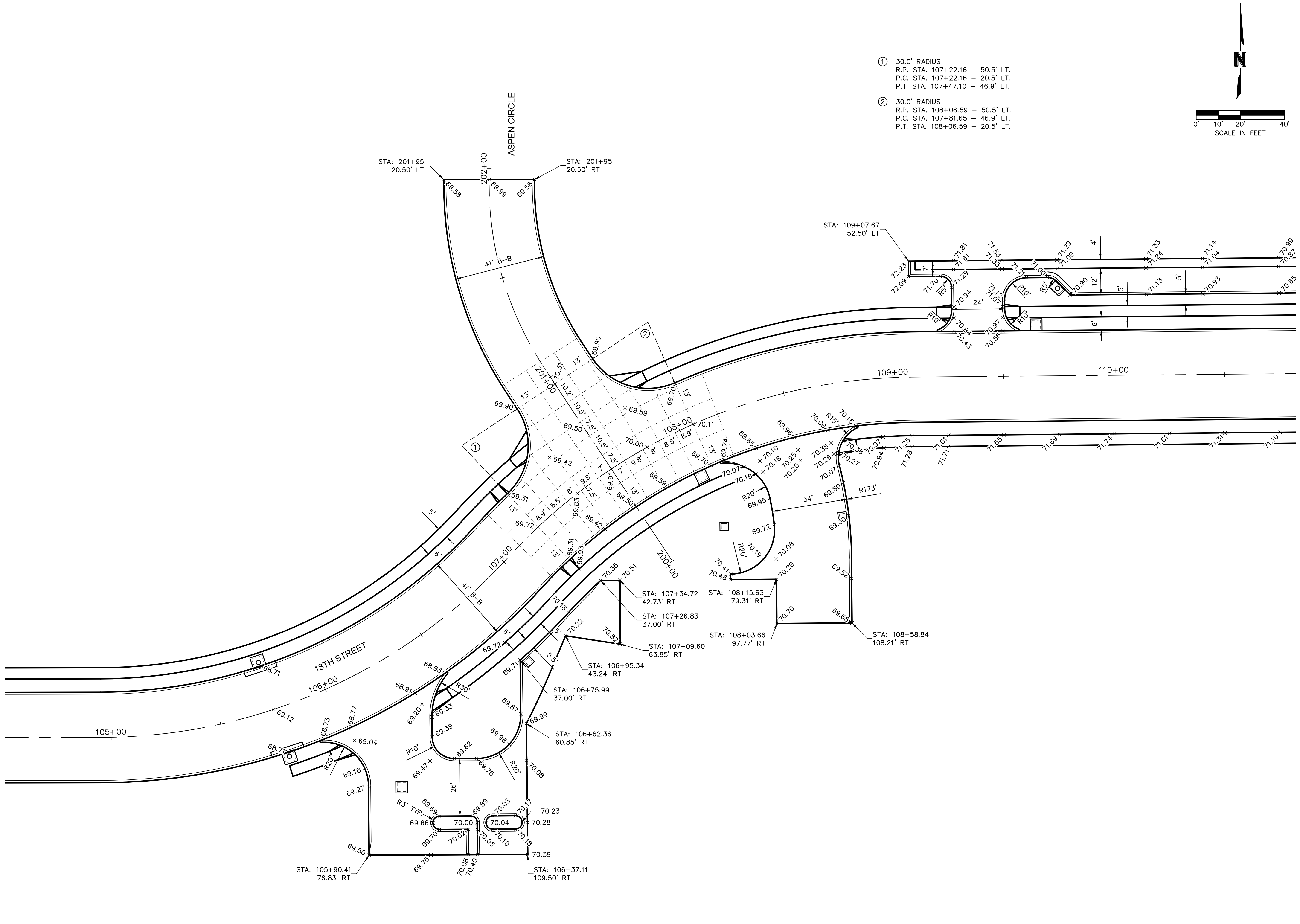

- ① 30.0' RADIUS
 R.P. STA. 107+22.16 - 50.5' LT.
 P.C. STA. 107+22.16 - 20.5' LT.
 P.T. STA. 107+47.10 - 46.9' LT.
- ② 30.0' RADIUS
 R.P. STA. 108+06.59 - 50.5' LT.
 P.C. STA. 107+81.65 - 46.9' LT.
 P.T. STA. 108+06.59 - 20.5' LT.

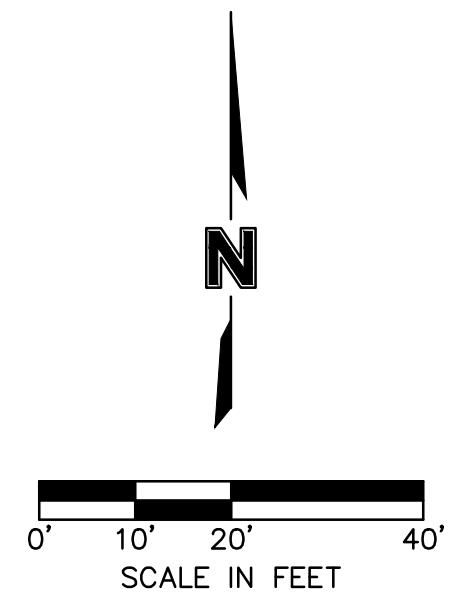

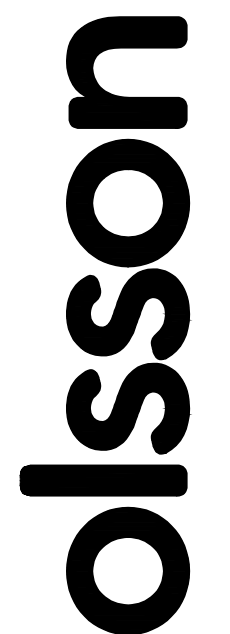

201 East 2nd Street
Grand Island, NE 68801 TEL 308.384.8750 www.olson.com

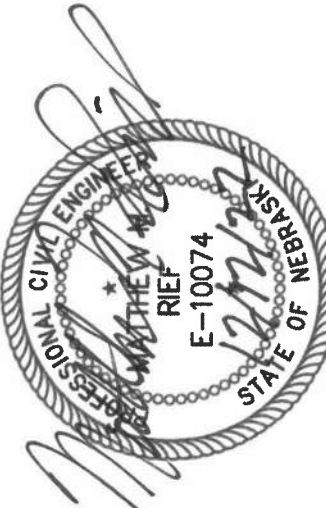

| REV. NO. | DATE | REVISIONS DESCRIPTION |
|----------|------|-----------------------|
| | | |
| | | |
| | | |
| | | |

GEOMETRICS, JOINTS & GRADES
 STA. 105+00 TO STA. 110+00

18TH STREET - MOORES CREEK TO DIERS AVENUE
 ROADWAY IMPROVEMENTS; PROJECT #2022-P-8

GRAND ISLAND, NEBRASKA

2022

REVISIONS

| | |
|------------------------|-----|
| drawn by: _____ | HLM |
| checked by: _____ | |
| approved by: _____ | |
| QA/QC by: _____ | |
| project no.: 021-07494 | |
| drawing no.: _____ | |
| date: 12.19.2022 | |

SHEET
23 of 35

18TH STREET - MOORES CREEK TO DIERS AVENUE WATER MAIN PROJECT #2023-W-5 GRAND ISLAND, NEBRASKA 2022

GENERAL NOTES:

1. ALL WORK SHALL BE IN ACCORDANCE WITH THE CITY OF GRAND ISLAND STANDARD PLANS AND SPECIFICATIONS-DIVISION VI.
2. THE LOCATION OF ALL AERIAL AND UNDERGROUND UTILITY FACILITIES MAY NOT BE INDICATED ON THESE PLANS. UNDERGROUND UTILITIES, WHETHER INDICATED OR NOT WILL BE LOCATED AND FLAGGED BY THE UTILITIES AT THE REQUEST OF THE CONTRACTOR. NO EXCAVATION WILL BE PERMITTED IN THE AREA OF UNDERGROUND UTILITY FACILITIES UNTIL ALL SUCH FACILITIES HAVE BEEN LOCATED AND IDENTIFIED TO THE SATISFACTION OF ALL PARTIES. THE EXCAVATION MUST BE ACCOMPLISHED WITH EXTREME CARE IN ORDER TO AVOID ANY POSSIBILITY OF DAMAGE TO THE UTILITY FACILITY. THE CONTRACTOR SHALL BE RESPONSIBLE FOR ALL DAMAGES.
3. CONTRACTOR SHALL PRESERVE ALL PROPERTY CORNER MONUMENTS OR RE-ESTABLISH THEM IF THEY ARE DISTURBED DURING CONSTRUCTION.
4. THE CONTRACTOR SHALL OBTAIN AND PAY THE COST OF ALL REQUIRED PERMITS AND FEES.
5. CONTRACTOR TO PROVIDE ALL INCIDENTAL FITTINGS NECESSARY TO COMPLETE WORK.
6. CONTRACTOR SHALL BE RESPONSIBLE FOR ALL COSTS OF TESTS AS REQUIRED INCLUDING WATER LINE TESTING AND DISINFECTION.
7. TRENCH EXCAVATION SHALL MEET ALL OSHA REGULATIONS, AND BE AT MINIMUM 6' WIDE X 6' LONG. IF TRENCH IS LESS THAN 6' IN EITHER DIRECTION, THE CONTRACTOR SHALL SUPPLY AND INSTALL A TRENCH BOX OR SHORING.
8. TRENCH EXCAVATION & BACKFILL SHALL BE MECHANICALLY TAMPED BY THE CONTRACTOR & TESTED. COMPACTION REQUIREMENTS SHALL BE IN ACCORDANCE WITH THE CITY OF GRAND ISLAND SPECIFICATIONS.
9. ALL BENDS SHALL BE BLOCKED OR UTILIZE RESTRAINED JOINTS AS APPROVED BY ENGINEER. FOR DETAILS OF THRUST BLOCKS, ANCHORS, AND TEE BLOCKS, SEE G.I. STANDARD PLAN 134.
10. NEW WATER MAIN SHALL BE DUCTILE IRON PIPE.
11. ALL DUCTILE IRON PIPE SHALL BE 8 MIL POLYETHYLENE ENCASED, PER G.I. STD. PLAN 155, UNLESS WAIVER IS GRANTED BY THE UTILITY, POLYETHYLENE ENCASEMENT SHALL BE SUBSIDIARY TO PIPE.
12. CONCRETE BLOCKING FOR FITTINGS SHALL BE SUBSIDIARY TO THE FITTINGS.
13. THE GROUNDWATER ELEVATION AS OF 8/31/22 WAS 1860.92 RECORDED AT WELL 8 NEAR THE INTERSECTION OF US-281 AND 13TH STREET. THE RECORD HIGH ELEVATION IS 1865.61 AT THIS LOCATION ON 5/25/84.
14. ALL FIRE HYDRANTS AND VALVES REMOVED FOR THIS PROJECT SHALL BE SALVAGED TO THE GRAND ISLAND WATER DEPARTMENT.

WATER MAIN TAP:

1. UNDER THE SUPERVISION OF G.I. UTILITY ENGINEERING OR WATER SHOP PERSONNEL, THE CONTRACTOR MAY INSTALL WET VALVES, WET TEES, HYDRANT EXTENSIONS, WET PLUGS, AND WET CAPS. ALL TAPS ARE TO BE PERFORMED BY THE WATER SHOP (308.385.5436). ALL INSTALLATIONS OF PIPE SECTIONS LENGTHS OF 20' OR GREATER REQUIRE FULL TESTING BEFORE BEING PLACED BACK IN SERVICE.
2. CONTRACTOR WILL BE RESPONSIBLE FOR:
 - 2.1. PROVIDING ALL NECESSARY FITTINGS AND VALVES.
 - 2.2. EXCAVATING, BACKFILLING, AND RESTORING THE LOCATION.
 - 2.3. PUMPING OUT THE PIT DURING INSTALLATION.
 - 2.4. SHORING PIT (IF DEEMED NECESSARY BY THE UTILITY).
 - 2.5. THRUST BLOCKING ALL TAPPING VALVES.
3. CONTRACTOR MUST COORDINATE INSTALLATION WITH UTILITY ENGINEERING (308.385.5463) OR A UTILITY ENGINEERING REPRESENTATIVE. CONTACT MUST BE MADE AT LEAST 48 HOURS PRIOR TO COMMENCEMENT OF WORK.



| DRAWING INDEX | |
|---------------|-----------------------------|
| 25 | COVER SHEET |
| 27-26 | WATER DETAILS |
| 28 | WATER MAIN PLAN AND PROFILE |

| SUMMARY OF QUANTITIES | | |
|---------------------------------|------|----------|
| ITEM DESCRIPTION | UNIT | QUANTITY |
| 8" D.I. WATER MAIN | L.F. | 492 |
| TYPE 1 FIRE HYDRANT ASSEMBLY | EA. | 1 |
| TYPE 2 FIRE HYDRANT ASSEMBLY | EA. | 1 |
| 8" GATE VALVE W/BOX | EA. | 1 |
| DUCTILE IRON FITTINGS | LBS. | 1165 |
| 8" TAPPING SLEEVE & VALVE W/BOX | EA. | 2 |
| IN-LINE I BEAM BLOCK | EA. | 2 |
| 2" CORPORATION STOP | EA. | 1 |
| 2" CURB STOP | EA. | 1 |
| 2" SERVICE TUBING | L.F. | 59 |
| RECONNECT WATER SERVICE | EA. | 1 |
| CONCRETE JOINT ENCASEMENT | EA. | 4 |
| TESTING & SAMPLING TAP | EA. | 2 |
| REMOVE AND SALVAGE FIRE HYDRANT | EA. | 2 |
| ABANDON VALVE | EA. | 1 |

WATER MAIN PROJECT 2023-W-5
CITY OF GRAND ISLAND APPROVALS

PUBLIC WORKS
APPROVED

FIRE DEPARTMENT
APPROVED

UTILITIES DIRECTOR

DATE

| ALIGNMENT CONTROL | | | | | |
|-------------------|------------------------|------------------------------|------------------------------|-------------|-------------|
| LINE ID # | STATION RANGE | START COORD. | END COORD. | DIRECTION | LENGTH (FT) |
| L1 | 804+75 805+36.53 | N: 107531.71 E: 111154.50 | N: 107530.95 E: 111092.98 | S89°17'43"W | 61.53 |
| L2 | 805+36.53 806+36.79 | N: 107530.95 E: 111092.98 | N: 107430.69 E: 111094.22 | S0°42'17"E | 100.27 |
| L3 | 806+36.79 808+14.09 | N: 107430.69 E: 111094.22 | N: 107430.87 E: 111271.51 | N89°56'31"E | 177.29 |
| L4 | 808+14.09 809+61.14 | N: 107430.87 E: 111271.51 | N: 107534.71 E: 111375.63 | N45°04'42"E | 147.05 |
| L5 | 809+61.14 809+84.08 | N: 107534.71 E: 111375.63 | N: 107557.65 E: 111375.66 | N0°04'42"E | 22.94 |
| L6 | 809+84.08 810+50 | N: 107557.65 E: 111375.66 | N: 107557.56 E: 111441.58 | S89°55'18"E | 65.92 |

HALL CO LDP
ALL SURVEY INFORMATION BASED ON HALL CO. LOW DISTORTION PROJECTION (LDP) FROM NEBRASKA STATE SURVEYOR'S OFFICE

BENCHMARKS
BMK A
CHISELED 'X' ON NW BOLT ON FIRE HYDRANT NORTH OF 13TH STREET, EAST OF MOORES CREEK ELEV 1873.42
BMK B
CHISELED 'X' ON NW BOLT ON FIRE HYDRANT NORTH OF 13TH STREET, 1ST FIRE HYDRANT WEST OF MOORES CREEK ELEV 1876.07
BMK C
CHISELED 'X' ON NW BOLT ON FIRE HYDRANT, NE CORNER OF MEADOW RD & SAGEWOOD AVE. ELEV 1876.39

PROJECTION: TRAVERSE MERCATOR
SCALE FACTOR: 1.0000868
CENTRAL MERIDIAN: 98°26'00" WEST
STAND PARALLEL: 40°52'00" NORTH
FALSE N/E: 25000/30000
SPHEROID: GRS80
DATUM: NAD 83
VERTICAL DATUM: NAVD 88

DWG: F:\2021\07001-07500\021-07494\40-Design\AutoCAD\Final Plans\Sheets\GNCV\18th Street\C_COV-18TH St-WAT_02107494.dwg
 DATE: Dec 19, 2022 2:29pm
 USER: zlocemis
 XREFS: C:\ITLBIK\18TH_02107494

201 East 2nd Street
Grand Island, NE 68801 TEL 308.384.8750 www.olsson.com

| REVISIONS DESCRIPTION | DATE | REV. NO. | REVISIONS |
|-----------------------|------|----------|-----------|
| | | | |

WATER MAIN COVER SHEET

18TH STREET - MOORES CREEK TO DIERS AVENUE
ROADWAY IMPROVEMENTS; PROJECT #2022-P-8

GRAND ISLAND, NEBRASKA

drawn by: _____
 checked by: _____
 approved by: _____
 QA/QC by: _____
 project no.: 021-07494
 date: 12.19.2022

SHEET
 25 of 35

DWG: F:\2021\07001-07494\40-Design\AutoCAD\Final Plans\Sheets\GNV\18th Street\C_DTL_WTR-18TH St_02107494.dwg
 DATE: Dec 19, 2022 2:30pm
 USER: zloomis
 XREFS: C:\TTLB\K-18TH_02107494

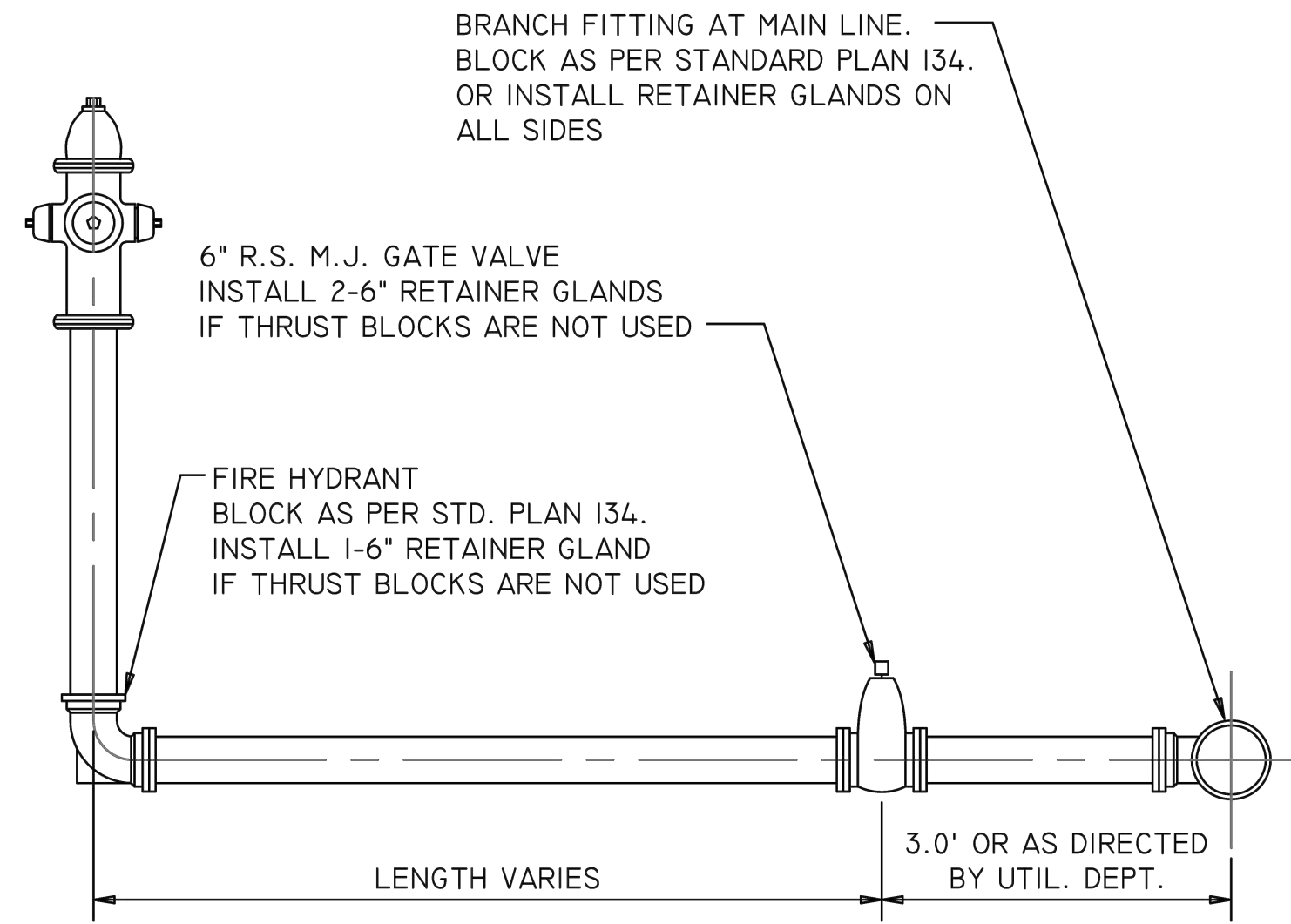

FIRE HYDRANT - TYPE 1
 GRAND ISLAND STANDARD PLAN 140
 NOT TO SCALE

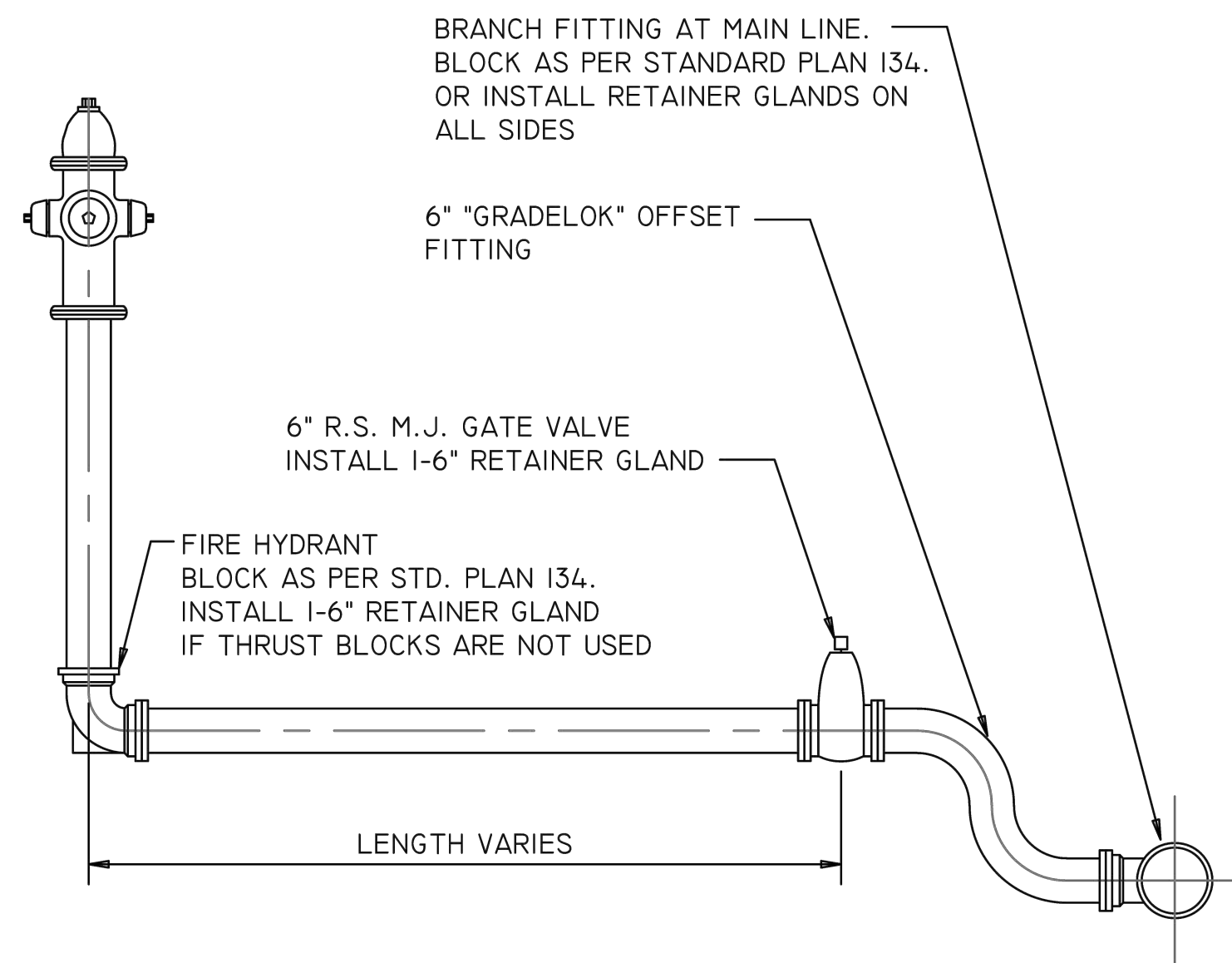

FIRE HYDRANT - TYPE 2
 GRAND ISLAND STANDARD PLAN 140
 NOT TO SCALE

HYDRANT NOTES

- IF RETAINER GLANDS ARE INSTALLED ON ALL JOINTS AND THRUST BLOCKS ARE NOT USED DOWNSTREAM OF THE BRANCH FITTING, RETAINER GLANDS SHALL BE INSTALLED ON ALL SIDES OF THE BRANCH FITTING. THE USE OF RETAINER GLANDS IN PLACE OF THRUST BLOCKS SHALL BE AT THE DISCRETION OF THE UTILITIES DEPT.
- EACH FIRE HYDRANT INSTALLATION SHALL BE ITEMIZED FOR PAYMENT AT CONTRACT UNIT PRICES FOR ALL INDIVIDUAL MATERIAL AND FITTINGS REQUIRED TO COMPLETE THE ASSEMBLY.
- THE CONTRACTOR SHALL SET OR TURN ALL FIRE HYDRANTS SO THE PUMPER NOZZLE FACES THE DRIVEN ROADWAY OR AS OTHERWISE DIRECTED BY THE UTILITIES DEPARTMENT.
- WHERE FIRE HYDRANTS ARE LOCATED IN A HARD SURFACED ISLAND OR PARKING AREA, THE CONTRACTOR SHALL PROVIDE AN 18" BLOCK-OUT AROUND THE HYDRANT BARREL FILLED WITH COMPACTED SOIL.
- FIRE HYDRANTS SHALL BE INSTALLED A MINIMUM OF 18" FROM THE EDGE OF ANY SIDEWALK AND A MINIMUM OF 6' FROM ANY DRIVING LANE.
- FIRE HYDRANT SHALL BE SET ON COMMON PAVER BLOCK TO ESTABLISH CORRECT ELEVATION.
- FITTINGS AND ETC... FOR VERTICAL ADJUSTMENT MAY BE USED DOWNSTREAM OF THE HYDRANT AUXILIARY VALVE WITH APPROVAL OF THE UTILITIES DEPT.

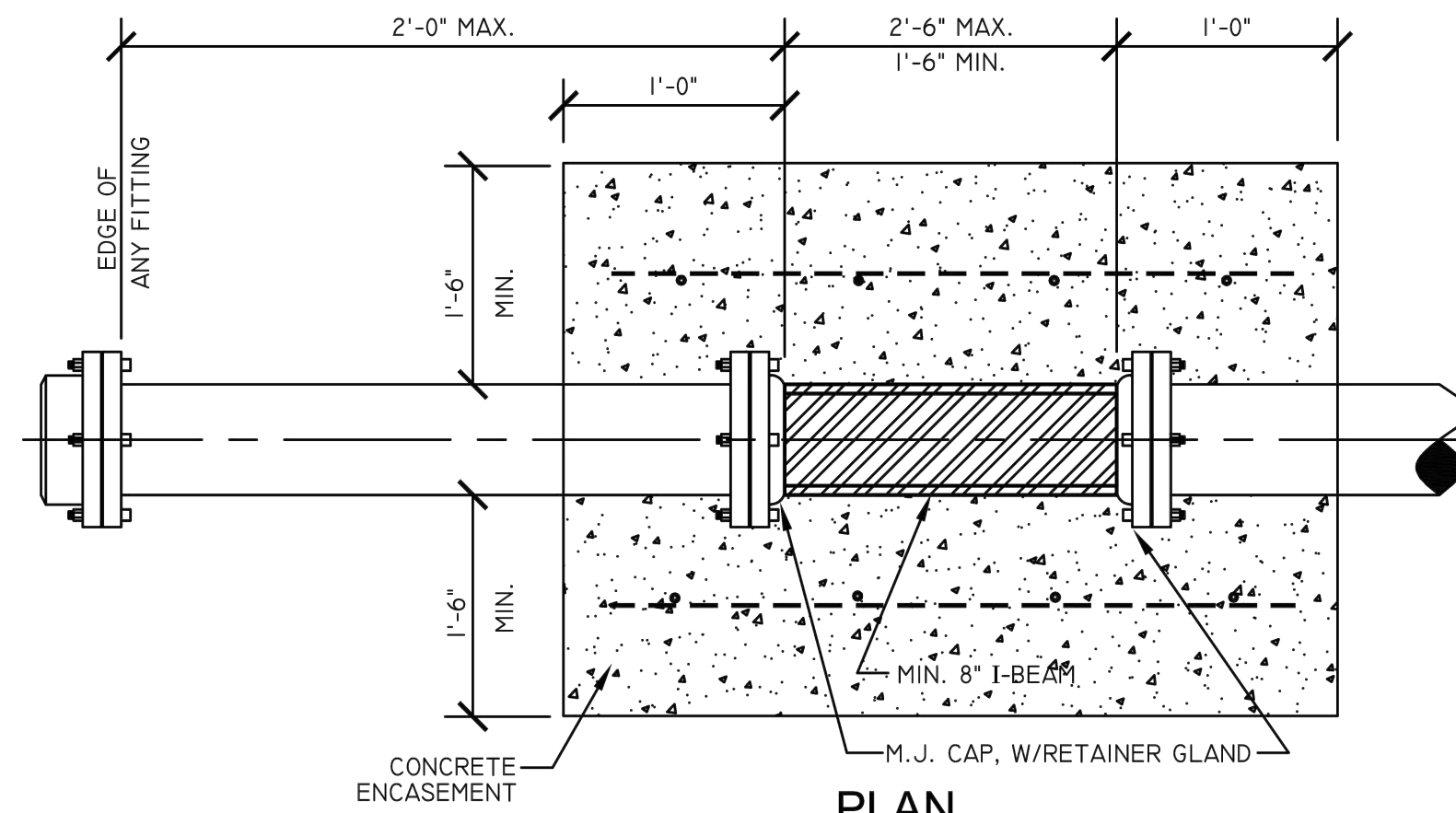

PLAN
 NO SCALE

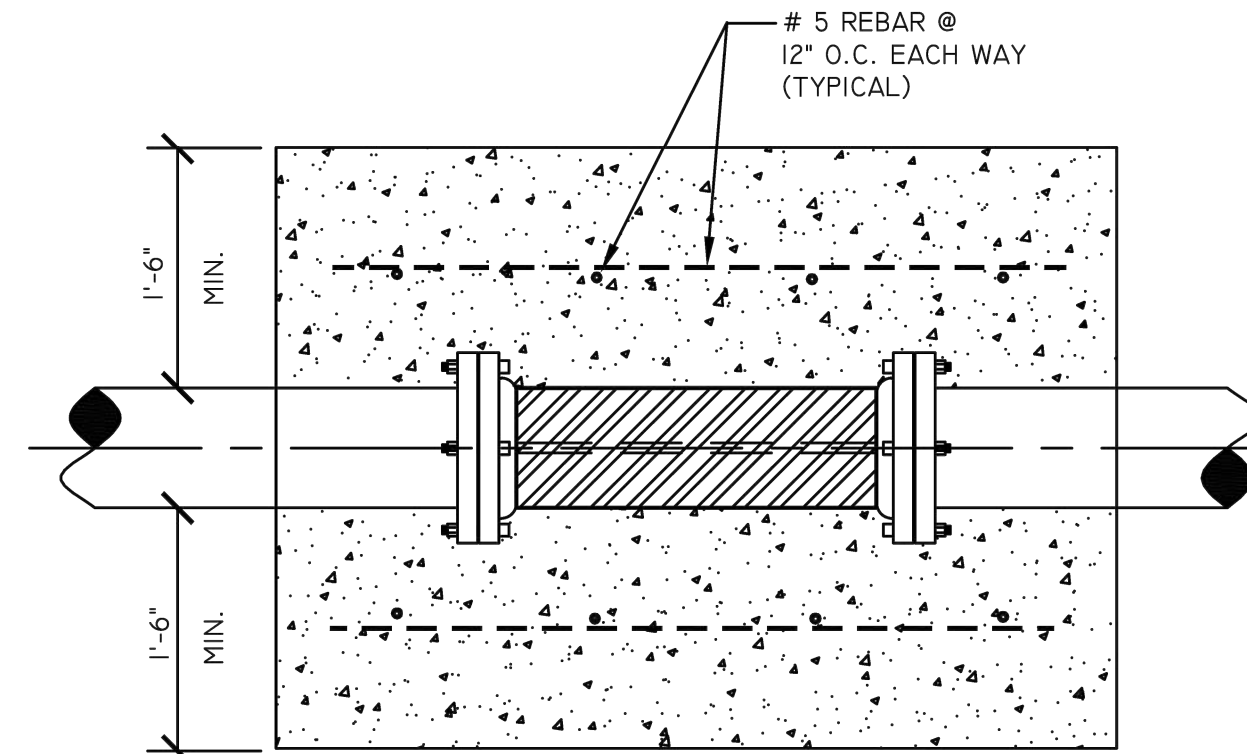

ELEVATION
 NO SCALE

GENERAL NOTES

- ALL THRUST BLOCKS TO BE TYPE 47-B MODIFIED POURED CONCRETE AS PER DIVISION II; "CONCRETE PAVING SPECIFICATIONS"; AND DIVISION VI "WATER MAINS".
- ALL THRUST BLOCKS ARE TO BE POURED AGAINST UNDISTURBED SOIL.

IN-LINE I BEAM BLOCK
 GRAND ISLAND STANDARD PLAN 156
 NOT TO SCALE

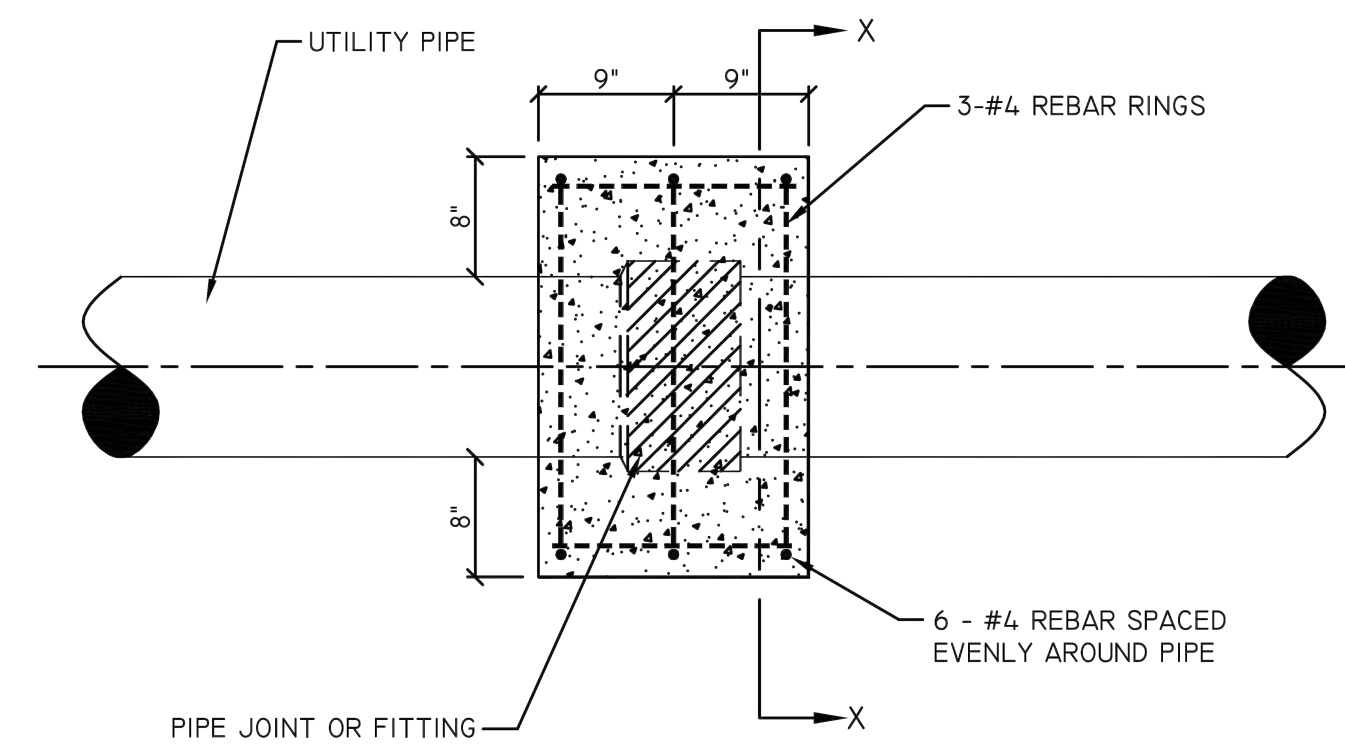

PLAN VIEW

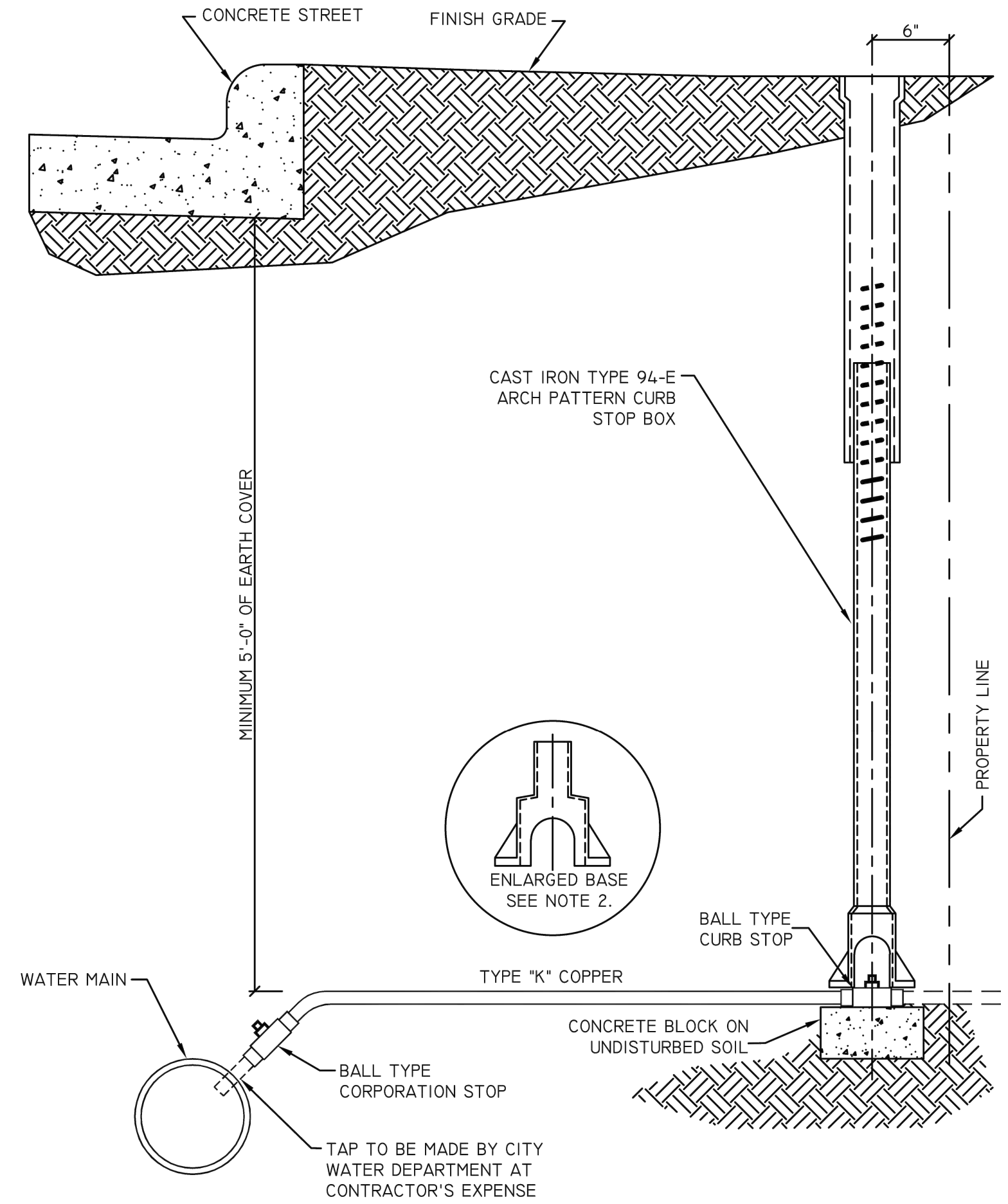

NOTES:

- A SERVICE SADDLE SHALL BE REQUIRED FOR ALL 1-1/2" AND LARGER TAPS ON ALL MAINS REGARDLESS OF PIPE THICKNESS CLASS.
- USE ADDITIONAL ENLARGED BASE WITH STANDARD 94-E BOX ON ALL 1-1/2" AND 2" CURB STOPS.

WATER SERVICE LINE
 GRAND ISLAND STANDARD PLAN 152
 NOT TO SCALE

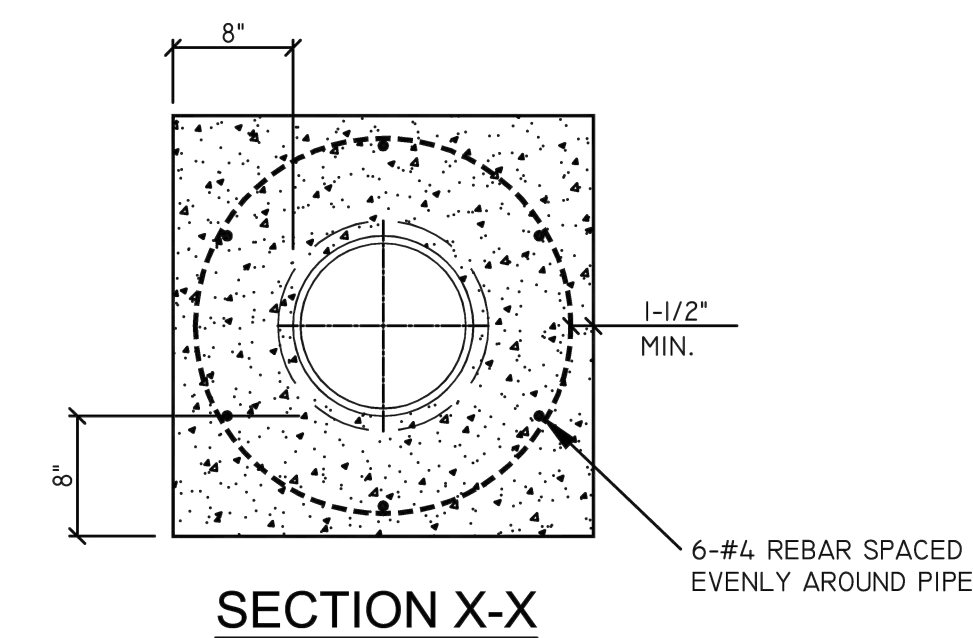

SECTION X-X

NOTES:

- ALL JOINT ENCASUREMENTS TO BE TYPE 47-B MODIFIED POURED CONCRETE AS PER DIVISION II; "CONCRETE PAVING SPECIFICATIONS"

JOINT ENCASUREMENT
 GRAND ISLAND STANDARD PLAN 133
 NOT TO SCALE

olsson

201 East 2nd Street
 Grand Island, NE 68801
 TEL 308.384.8750
 www.olsson.com

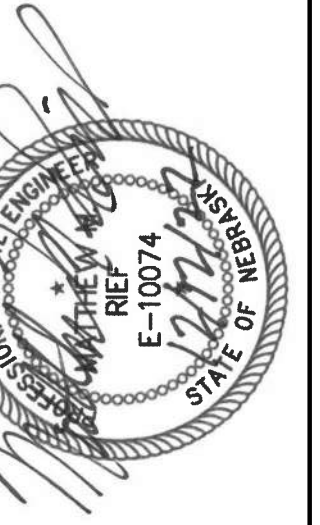

| REV. NO. | DATE | REVISIONS DESCRIPTION |
|----------|------|-----------------------|
| | | |
| | | |
| | | |
| | | |
| | | |
| | | |
| | | |
| | | |
| | | |

| | | |
|---------------------------|---|------|
| WATER MAIN DETAILS | 18TH STREET - MOORES CREEK TO DIERS AVENUE ROADWAY IMPROVEMENTS; PROJECT #2022-P-8 | 2022 |
| | GRAND ISLAND, NEBRASKA | |

| | |
|--------------|------------|
| drawn by: | ZLL |
| checked by: | ZLL |
| approved by: | MMR |
| QA/QC by: | |
| project no.: | 02107494 |
| drawing no.: | |
| date: | 12.19.2022 |

DWG: F:\2021\07001-07494\40-Design\AutoCAD\Final Plans\Sheets\18th Street\18TH ST_02107494.dwg
 DATE: Dec 19, 2022 2:30pm
 USER: zboomis
 C:\TTLBLK-18TH_02107494
 V_XRWAY_LDP_02107494

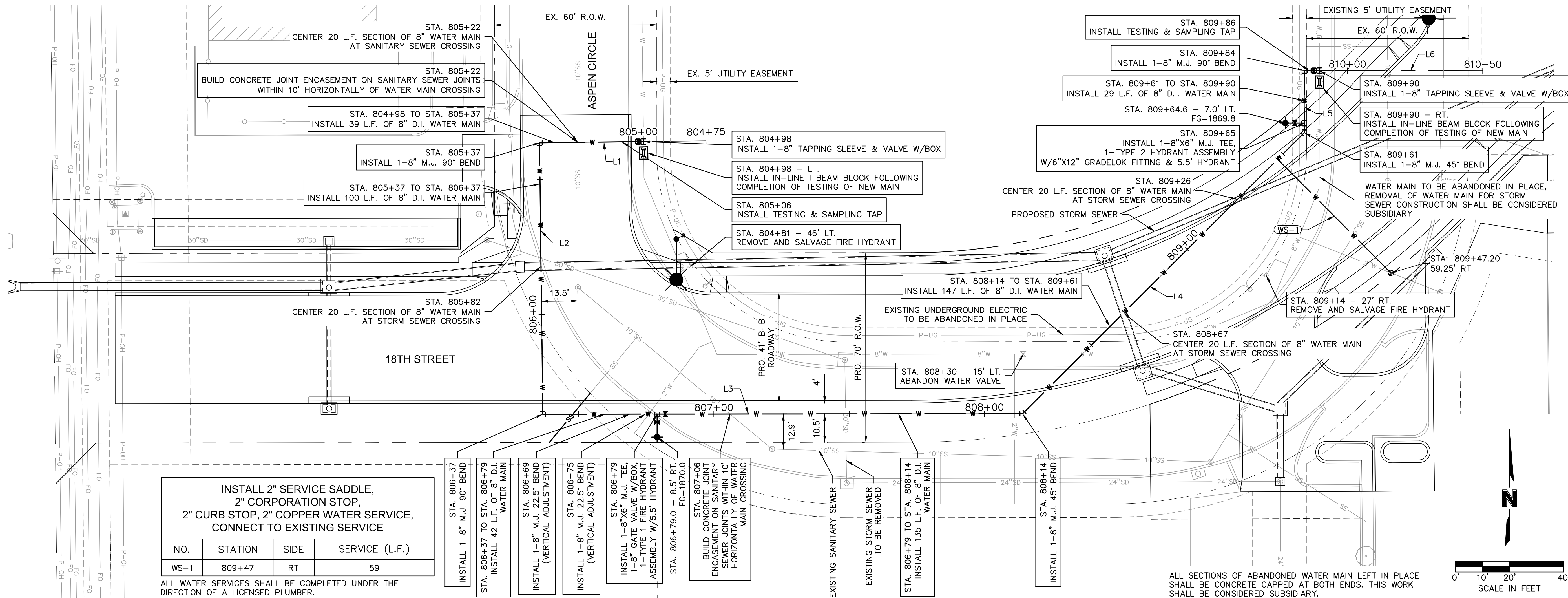

INSTALL 2" SERVICE SADDLE,
 2" CURB STOP, 2" COPPER WATER SERVICE,
 CONNECT TO EXISTING SERVICE

| NO. | STATION | SIDE | SERVICE (L.F.) |
|------|---------|------|----------------|
| WS-1 | 809+47 | RT | 59 |

ALL WATER SERVICES SHALL BE COMPLETED UNDER THE DIRECTION OF A LICENSED PLUMBER.

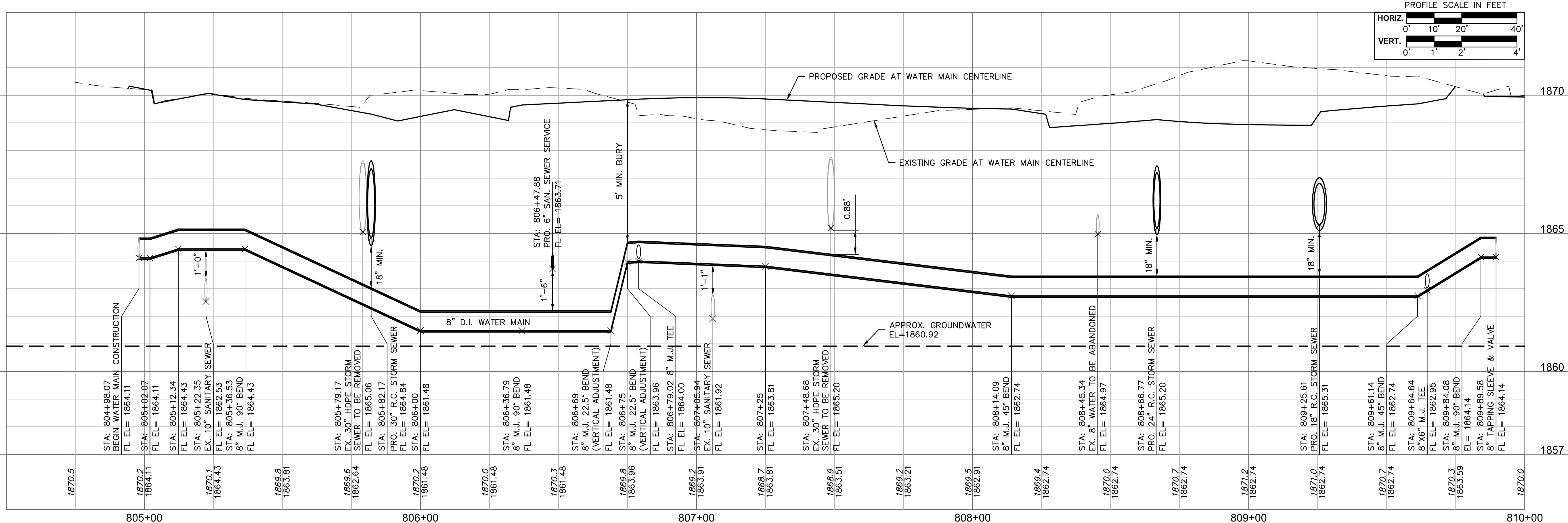

201 East 2nd Street
 Grand Island, NE 68801
 TEL 308.384.8750
 www.olson.com

| REV. NO. | DATE | REVISIONS DESCRIPTION |
|----------|------|-----------------------|
| | | |
| | | |

WATER MAIN PLAN AND PROFILE
 STA. 804+50 TO STA. 810+00

18TH STREET - MOORES CREEK TO DIERS AVENUE
 ROADWAY IMPROVEMENTS; PROJECT #2022-P-8

GRAND ISLAND, NEBRASKA

drawn by: _____
 checked by: _____
 approved by: _____
 project no.: 021-07494
 drawing no.: _____
 date: 12.19.2022

SHEET
 28 of 35

DWG: F:\2021\07001-07494\40-Design\AutoCAD\Final Plans\Sheets\GNCV\18th Street\C_ERC-18TH St_02107494.dwg
 DATE: Dec 19, 2022 2:31pm XREFS: V_XTOPO_LDP_02107494 C_PBASE-Link_02107494 C_TTLBLK-18TH_02107494 V_XRWAY_LDP_02107494 USER: zloomis

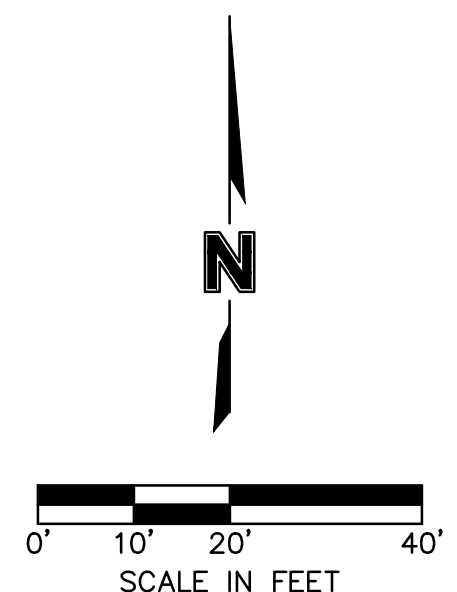
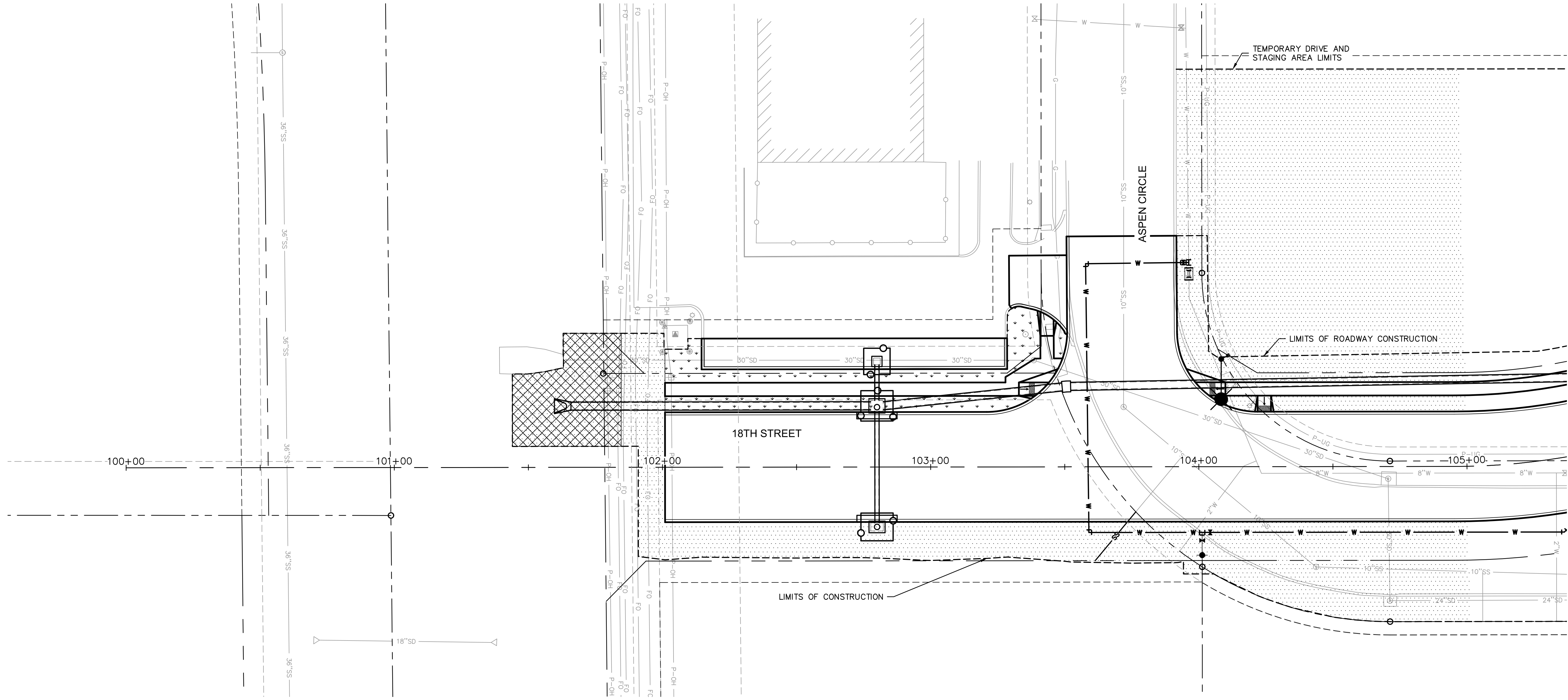

| SODDING | | |
|-----------------|------|-----|
| STA. TO STA. | SIDE | SY |
| 102+01 - 102+37 | LT. | 88 |
| 102+01 - 103+41 | LT. | 113 |
| 103+46 - 103+51 | LT. | 6 |

| SEEDING | | |
|-----------------|---------|------|
| STA. TO STA. | SIDE | SY |
| 101+44 - 105+00 | LT.&RT. | 959 |
| 104+05 - 104+22 | LT. | 8 |
| 104+27 - 105+00 | LT. | 48 |
| 103+92 - 105+00 | LT. | 1375 |

| EROSION CONTROL MAT, CLASS 1D | | |
|-------------------------------|------|-----|
| STA. TO STA. | SIDE | SY |
| 101+44 - 105+85 | LT. | 160 |

| INLET SEDIMENT FILTER | | |
|-----------------------|---------|----|
| STA. | SIDE | EA |
| 102+80 | 39' LT. | 1 |
| 102+80 | LT. | 1 |
| 102+80 | RT. | 1 |

| BUILD EROSION CONTROL LINEAR | | |
|------------------------------|---------|----|
| STA. TO STA. | SIDE | LF |
| 102+80 | 39' LT. | 39 |
| 102+80 | LT. | 47 |
| 102+80 | RT. | 45 |

| REV. NO. | DATE | REVISIONS DESCRIPTION |
|----------|------|-----------------------|
| | | |
| | | |
| | | |
| | | |

EROSION CONTROL
 STA. 100+00 TO STA. 105+00
 18TH STREET - MOORES CREEK TO DIERS AVENUE
 ROADWAY IMPROVEMENTS; PROJECT #2022-P-8
 GRAND ISLAND, NEBRASKA

drawn by: _____
 checked by: _____
 approved by: _____
 project no.: 021-07494
 drawing no.: _____
 date: 12.12.2022

olsson
 201 East 2nd Street
 Grand Island, NE 68801
 TEL 308.384.8750
 www.olsson.com

DWG: F:\2021\07001-07500\021-07494\40-Design\AutoCAD\Final Plans\Sheets\GNCV\18th Street\18TH St_02107494.dwg
 DATE: Dec 19, 2022 2:31pm XREFS: V_XTOPO_LDP_02107494 C_PBASE_Link_02107494 C_TTLBLK-18TH_02107494 V_XRWAY_LDP_02107494 USER: zloomis

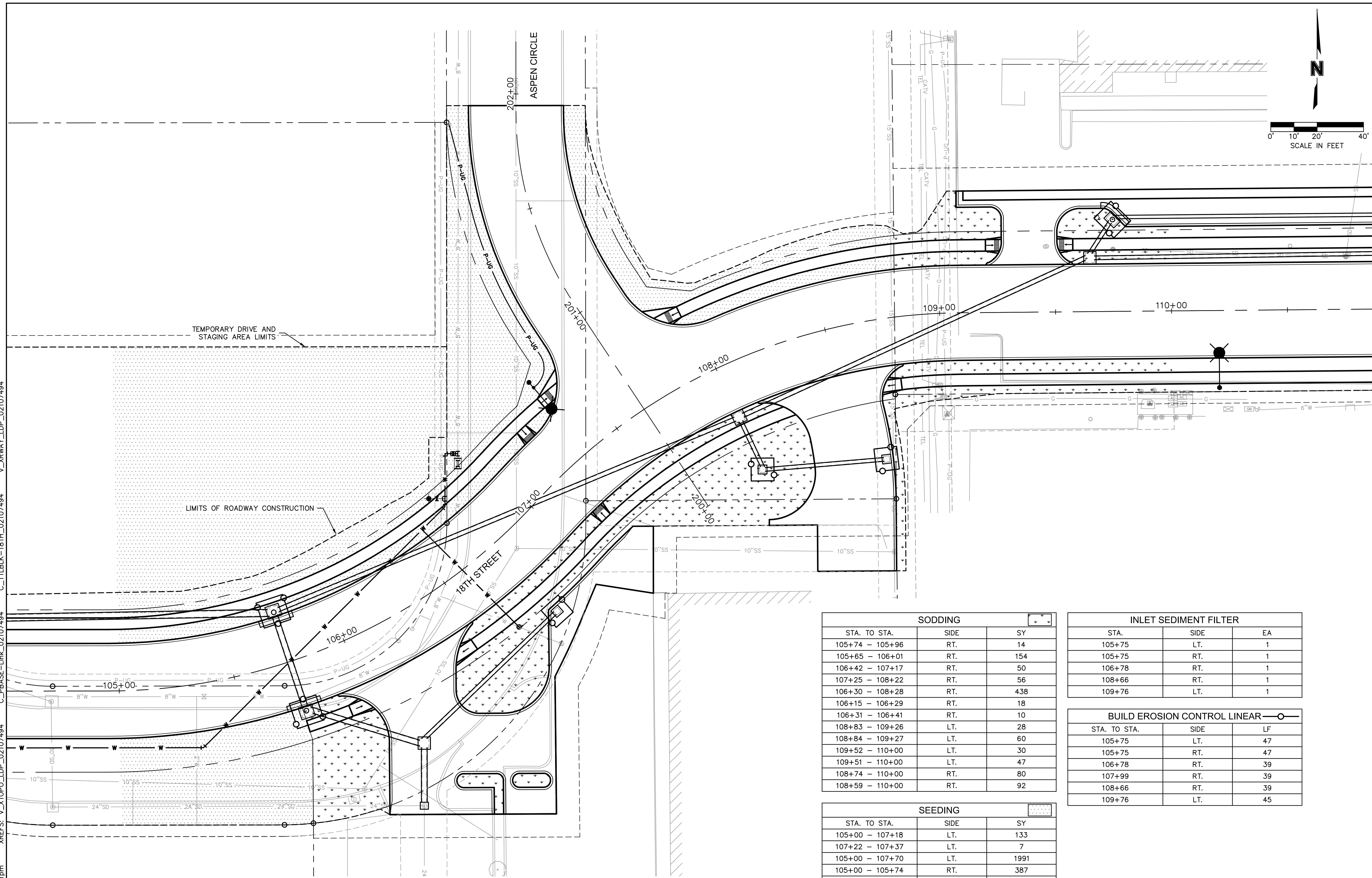

| SOODING | | |
|-----------------|------|-----|
| STA. TO STA. | SIDE | SY |
| 105+74 - 105+96 | RT. | 14 |
| 105+65 - 106+01 | RT. | 154 |
| 106+42 - 107+17 | RT. | 50 |
| 107+25 - 108+22 | RT. | 56 |
| 106+30 - 108+28 | RT. | 438 |
| 106+15 - 106+29 | RT. | 18 |
| 106+31 - 106+41 | RT. | 10 |
| 108+83 - 109+26 | LT. | 28 |
| 108+84 - 109+27 | LT. | 60 |
| 109+52 - 110+00 | LT. | 30 |
| 109+51 - 110+00 | LT. | 47 |
| 108+74 - 110+00 | RT. | 80 |
| 108+59 - 110+00 | RT. | 92 |

| SEEDING | | |
|-----------------|------|------|
| STA. TO STA. | SIDE | SY |
| 105+00 - 107+18 | LT. | 133 |
| 107+22 - 107+37 | LT. | 7 |
| 105+00 - 107+70 | LT. | 1991 |
| 105+00 - 105+74 | RT. | 387 |
| 107+92 - 108+83 | LT. | 63 |
| 107+82 - 108+84 | LT. | 225 |

| INLET SEDIMENT FILTER | | |
|-----------------------|------|----|
| STA. | SIDE | EA |
| 105+75 | LT. | 1 |
| 105+75 | RT. | 1 |
| 106+78 | RT. | 1 |
| 108+66 | RT. | 1 |
| 109+76 | LT. | 1 |

| BUILD EROSION CONTROL LINEAR | | |
|------------------------------|------|----|
| STA. TO STA. | SIDE | LF |
| 105+75 | LT. | 47 |
| 105+75 | RT. | 47 |
| 106+78 | RT. | 39 |
| 107+99 | RT. | 39 |
| 108+66 | RT. | 39 |
| 109+76 | LT. | 45 |

olsson
 201 East 2nd Street
 Grand Island, NE 68801 TEL 308.384.8750 www.olsson.com

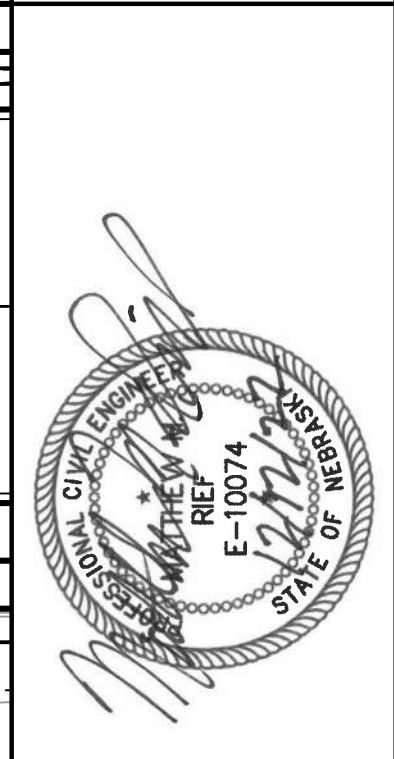

| REV. NO. | DATE | REVISIONS DESCRIPTION |
|----------|------|-----------------------|
| | | |
| | | |
| | | |
| | | |
| | | |

EROSION CONTROL
 STA. 105+00 TO STA. 110+00
 18TH STREET - MOORES CREEK TO DIERS AVENUE
 ROADWAY IMPROVEMENTS; PROJECT #2022-P-8
 GRAND ISLAND, NEBRASKA

drawn by: _____
 checked by: _____
 approved by: _____
 QA/QC by: _____
 project no.: 021-07494
 drawing no.: _____
 date: 12.12.2022

DWG: F:\2021\07001-07494\40-Design\AutoCAD\Final Plans\Sheets\GNCV\18th Street\ERC-18TH St_02107494.dwg
 DATE: Dec 19, 2022 2:31pm XREFS: V_XTOFO_LDP_02107494 C_PBASE-Link_02107494 C_TTLBLK-18TH_02107494 V_XRWAY_LDP_02107494 USER: zloomis

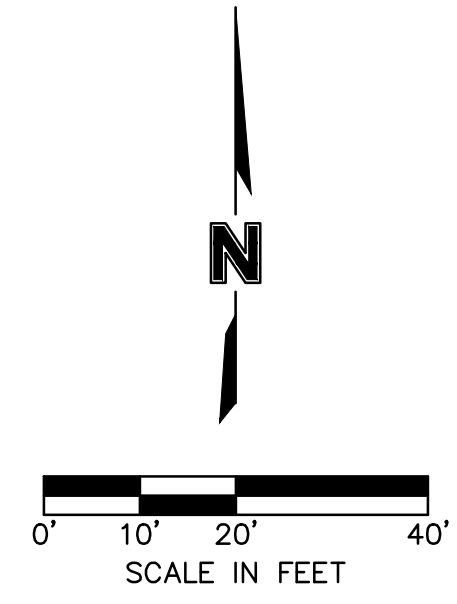
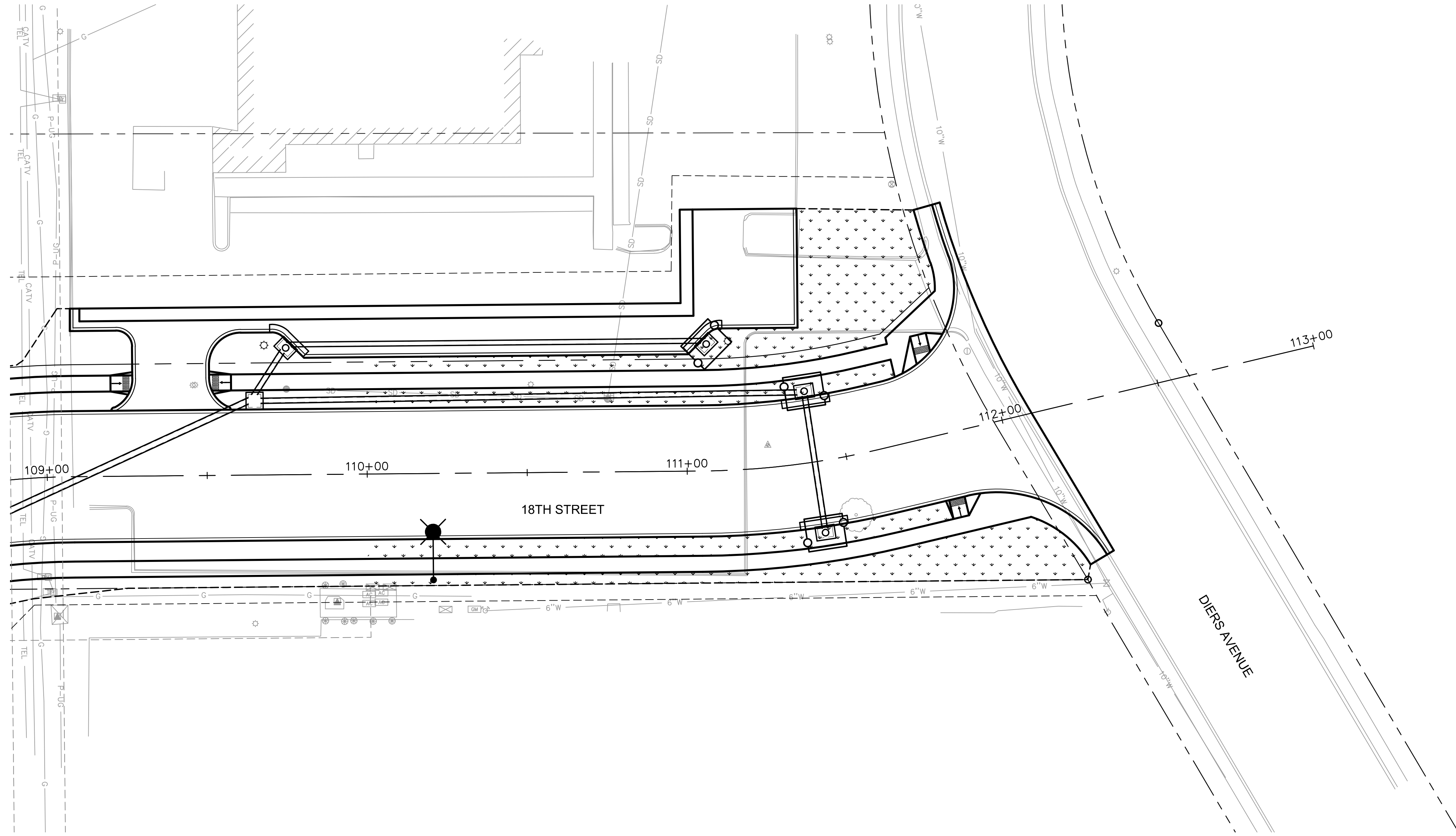

| SODDING | | |
|-----------------|------|-----|
| STA. TO STA. | SIDE | SY |
| 110+00 - 111+70 | LT. | 110 |
| 110+00 - 111+90 | LT. | 286 |
| 110+00 - 111+78 | RT. | 122 |
| 110+00 - 112+16 | RT. | 177 |

| INLET SEDIMENT FILTER | | |
|-----------------------|------|----|
| STA. | SIDE | EA |
| 111+05 | LT. | 1 |
| 111+40 | LT. | 1 |
| 111+40 | RT. | 1 |

| BUILD EROSION CONTROL LINEAR | | |
|------------------------------|------|----|
| STA. TO STA. | SIDE | LF |
| 111+05 | LT. | 45 |
| 111+40 | LT. | 45 |
| 111+40 | RT. | 45 |

drawn by: _____
 checked by: _____
 approved by: _____
 QA/QC by: _____
 project no.: 021-07494
 drawing no.: _____
 date: 12.12.2022

| | | | |
|---|-----------|------|-----------------------|
| CONSTRUCTION STA. 110+00 TO STA. 113+00 | REV. NO. | DATE | REVISIONS DESCRIPTION |
| | | | |
| 18TH STREET - MOORES CREEK TO DIERS AVENUE ROADWAY IMPROVEMENTS; PROJECT #2022-P-8 | REVISIONS | | |
| | 2022 | | |

| | | | |
|-----------|--|--|--|
| REVISIONS | | | |
| | | | |
| | | | |
| | | | |
| | | | |
| | | | |
| | | | |
| | | | |
| | | | |
| | | | |

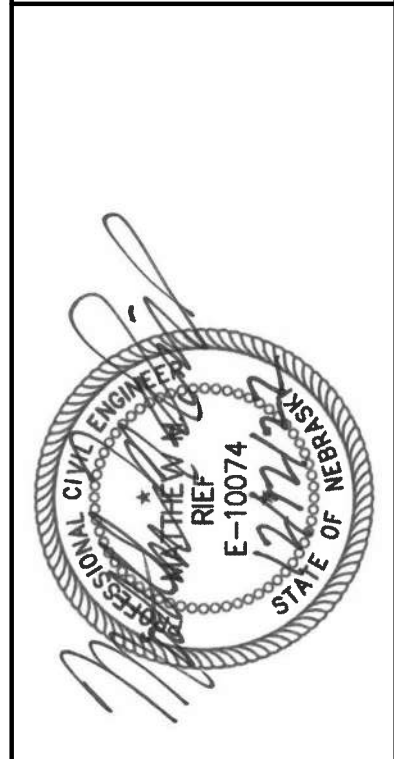

DWG: F:\2021\07001-07500\021-07494\40-Design\AutoCAD\Final Plans\Sheets\GNCV\18th Street\C_ROW-18TH_St_02107494.dwg
 DATE: Dec 19, 2022 2:31pm XREFS: V_XTOFO_LDP_02107494 C_PBASE-Link_02107494 C_TTLBLK-18TH_02107494 V_XRWAY_LDP_02107494 USER: zloomis

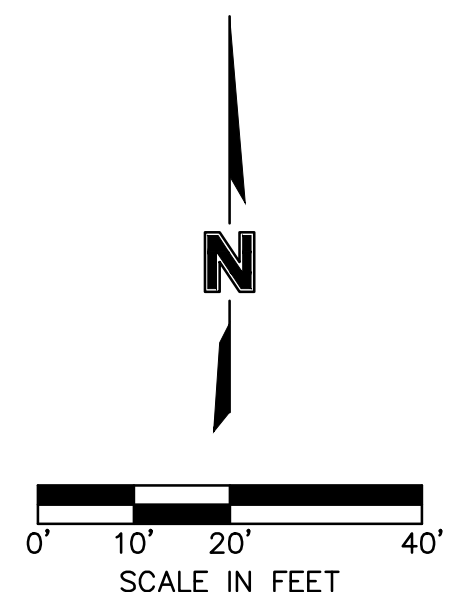
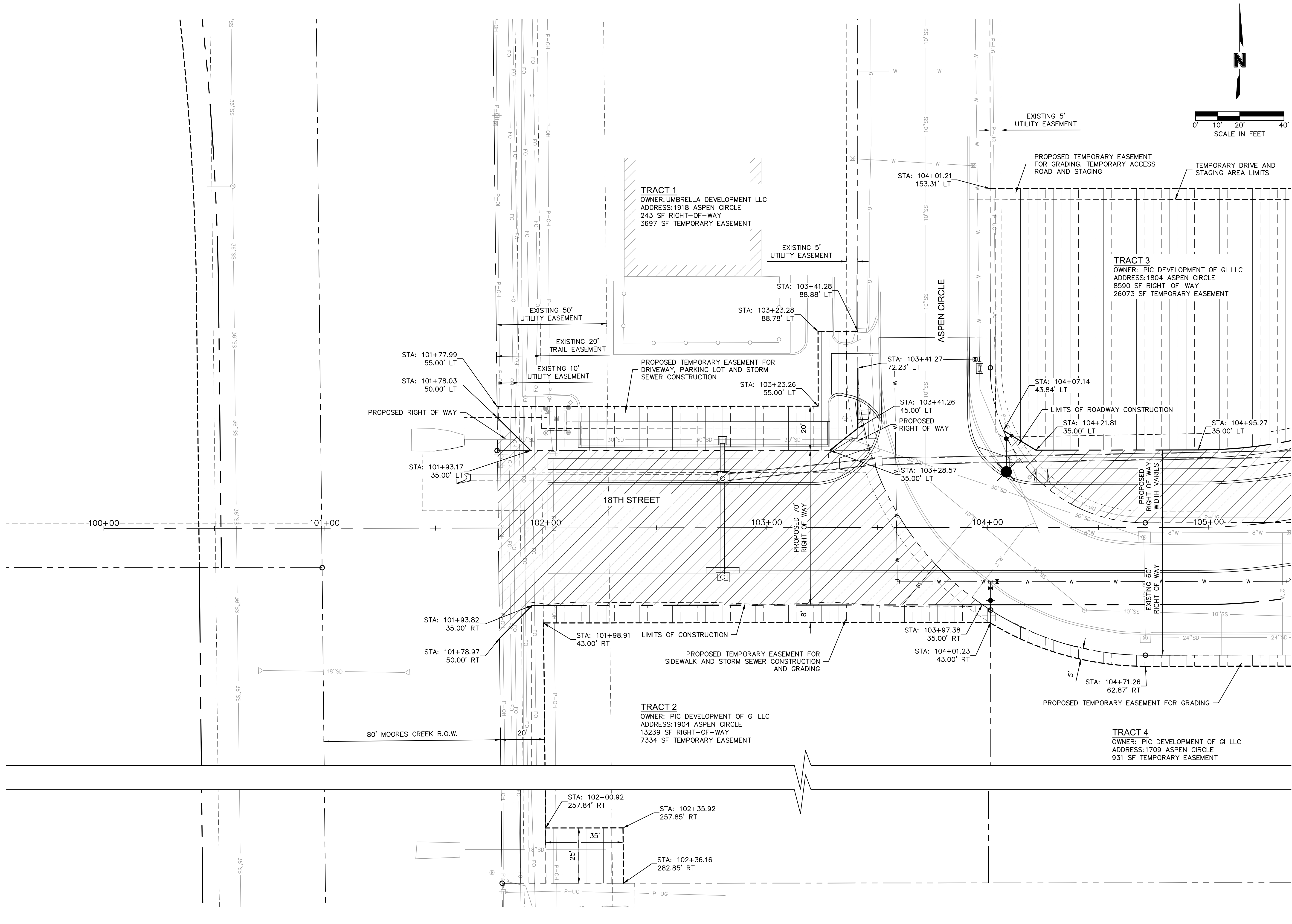

olsson
 201 East 2nd Street
 Grand Island, NE 68801
 TEL 308.384.8750
 www.olsson.com

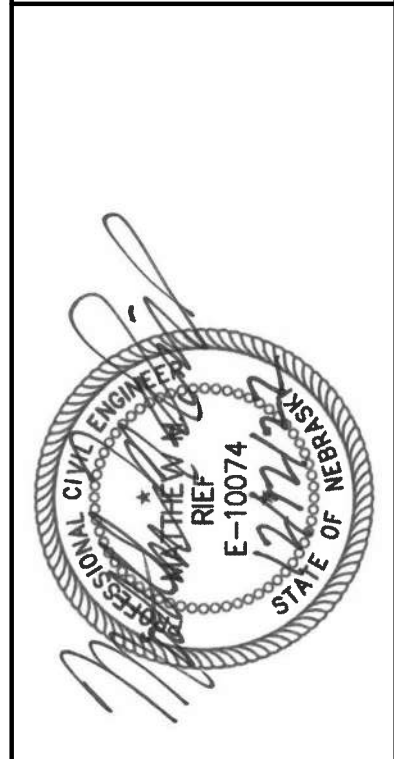

| REV. NO. | DATE | REVISIONS DESCRIPTION |
|----------|------|-----------------------|
| | | |
| | | |
| | | |
| | | |

RIGHT-OF-WAY
 STA. 100+00 TO STA. 105+00
 18TH STREET - MOORES CREEK TO DIERS AVENUE
 ROADWAY IMPROVEMENTS; PROJECT #2022-P-8
 GRAND ISLAND, NEBRASKA

drawn by: _____
 checked by: _____
 approved by: _____
 QA/QC by: _____
 project no.: 021-07494
 drawing no.: _____
 date: 10.17.2022

DWG: F:\2021\07001-07500\021-07494\40-Design\AutoCAD\Final Plans\Sheets\GNCV\18th Street\18TH St_02107494.dwg
 DATE: Dec 19, 2022 2:31pm
 XREFS: V_XTOPO_LDP_02107494 C_PBASE-Link_02107494 C_TTLBLK-18TH_02107494 V_XRWAY_LDP_02107494
 USER: zloomis

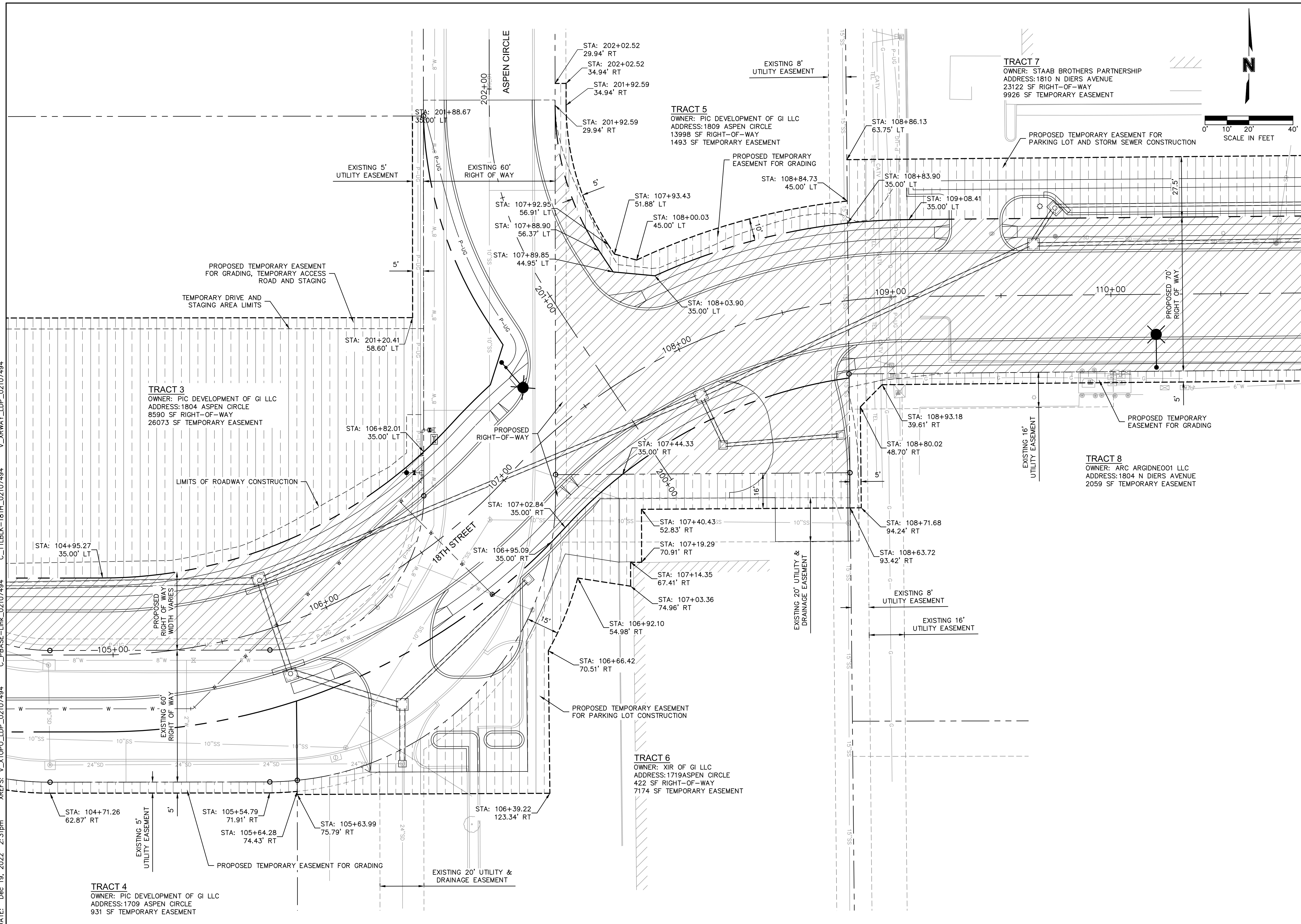

TRACT 4
 OWNER: PIC DEVELOPMENT OF GI LLC
 ADDRESS: 1709 ASPEN CIRCLE
 931 SF TEMPORARY EASEMENT

TRACT 3
 OWNER: PIC DEVELOPMENT OF GI LLC
 ADDRESS: 1804 ASPEN CIRCLE
 8590 SF RIGHT-OF-WAY
 26073 SF TEMPORARY EASEMENT

TRACT 5
 OWNER: PIC DEVELOPMENT OF GI LLC
 ADDRESS: 1809 ASPEN CIRCLE
 13998 SF RIGHT-OF-WAY
 1493 SF TEMPORARY EASEMENT

TRACT 6
 OWNER: XIR OF GI LLC
 ADDRESS: 1719 ASPEN CIRCLE
 422 SF RIGHT-OF-WAY
 7174 SF TEMPORARY EASEMENT

TRACT 7
 OWNER: STAAB BROTHERS PARTNERSHIP
 ADDRESS: 1810 N DIERS AVENUE
 23122 SF RIGHT-OF-WAY
 9926 SF TEMPORARY EASEMENT

TRACT 8
 OWNER: ARC ARGIDNE001 LLC
 ADDRESS: 1804 N DIERS AVENUE
 2059 SF TEMPORARY EASEMENT

olsson
 201 East 2nd Street
 Grand Island, NE 68801 TEL 308.384.8750 www.olson.com

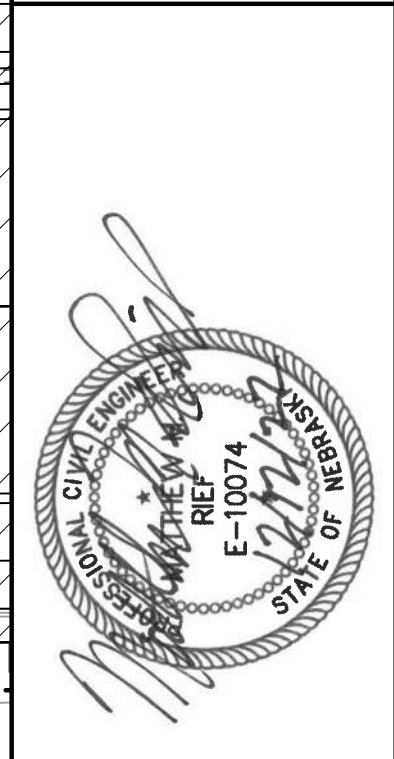

| REV. NO. | DATE | REVISIONS DESCRIPTION |
|----------|------|-----------------------|
| | | |
| | | |
| | | |
| | | |

| | | |
|---|------------|------|
| RIGHT-OF-WAY STA. 105+00 TO STA. 110+00 | | 2022 |
| 18TH STREET - MOORES CREEK TO DIERS AVENUE ROADWAY IMPROVEMENTS; PROJECT #2022-P-8 | | |
| GRAND ISLAND, NEBRASKA | | |
| drawn by: | | |
| checked by: | | |
| QA/QC by: | | |
| project no.: | 021-07494 | |
| date: | 10.17.2022 | |
| SHEET | | |
| 34 of 35 | | |

DWG: F:\2021\07001-07500\021-07494\40-Design\AutoCAD\Final Plans\Sheets\GNCV\18th Street\C_ROW-18TH St_02107494.dwg USER: zloomis
 DATE: Dec 19, 2022 2:31pm XREFS: V_XTOFO_LDP_02107494 C_PBASE-Link_02107494 C_TTLBLK-18TH_02107494 V_XRWAY_LDP_02107494

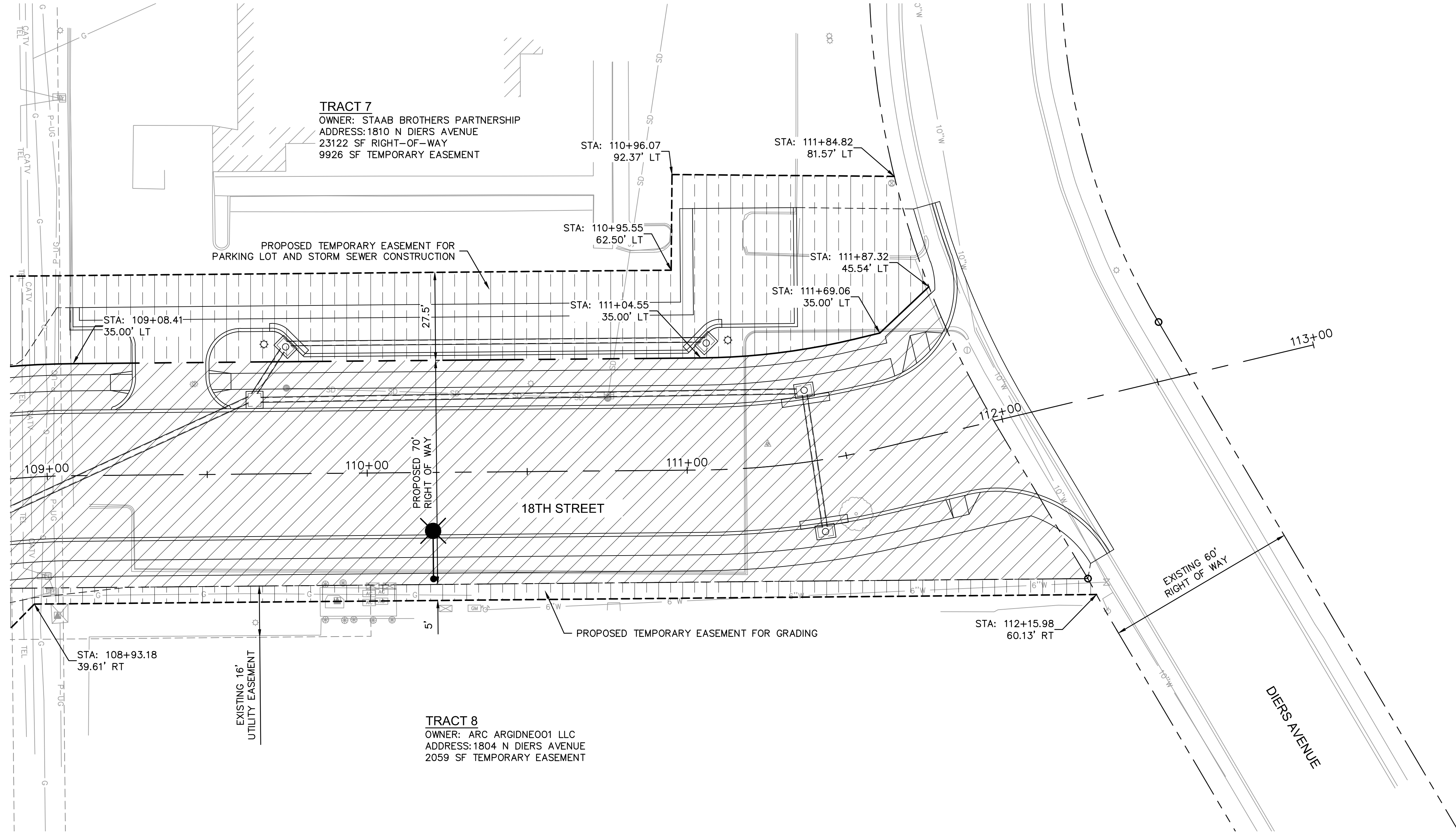

TRACT 7
 OWNER: STAAB BROTHERS PARTNERSHIP
 ADDRESS: 1810 N DIERS AVENUE
 23122 SF RIGHT-OF-WAY
 9926 SF TEMPORARY EASEMENT

TRACT 8
 OWNER: ARC ARGIDNEO01 LLC
 ADDRESS: 1804 N DIERS AVENUE
 2059 SF TEMPORARY EASEMENT

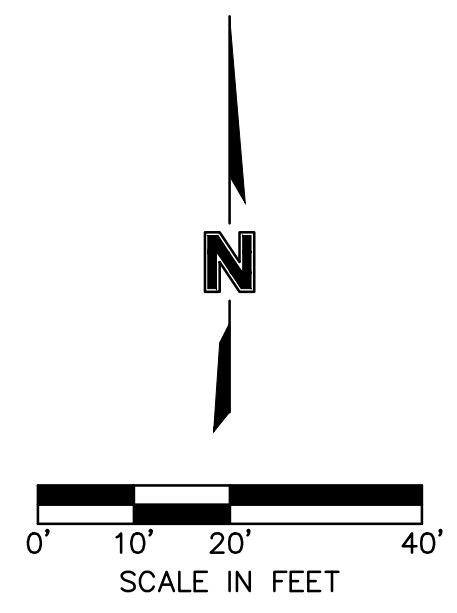

olsson

201 East 2nd Street
 Grand Island, NE 68801 TEL 308.384.8750 www.olson.com

| REV. NO. | DATE | REVISIONS DESCRIPTION |
|----------|------|-----------------------|
| | | |
| | | |
| | | |
| | | |

RIGHT-OF-WAY
 STA. 110+00 TO STA. 113+00

18TH STREET - MOORES CREEK TO DIERS AVENUE
 ROADWAY IMPROVEMENTS; PROJECT #2022-P-8

GRAND ISLAND, NEBRASKA

2022

REVISIONS

drawn by: _____
 checked by: _____
 approved by: _____
 QA/QC by: _____
 project no.: 021-07494
 drawing no.: _____
 date: 10.17.2022

SHEET
 35 of 35

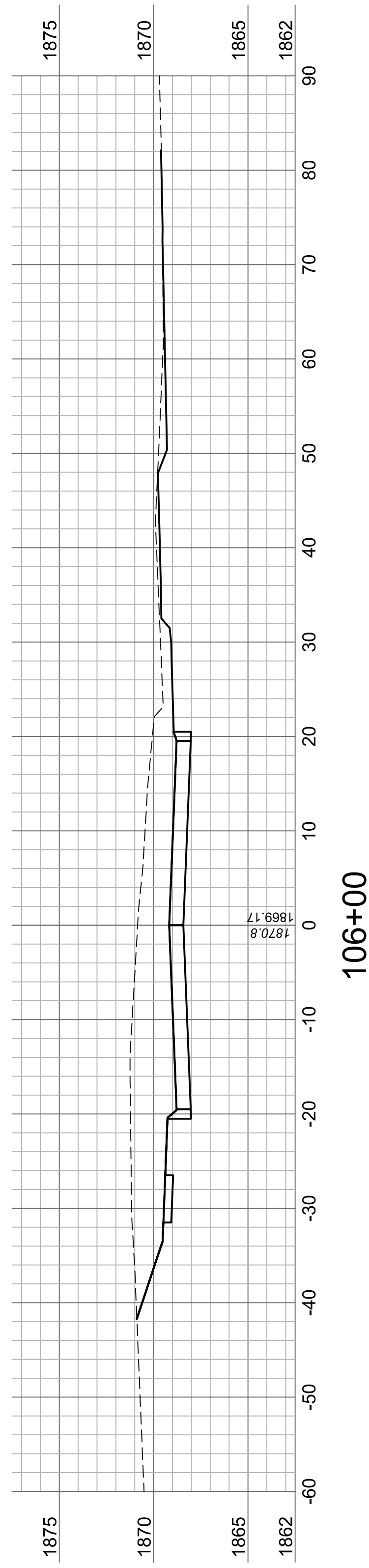

106+00

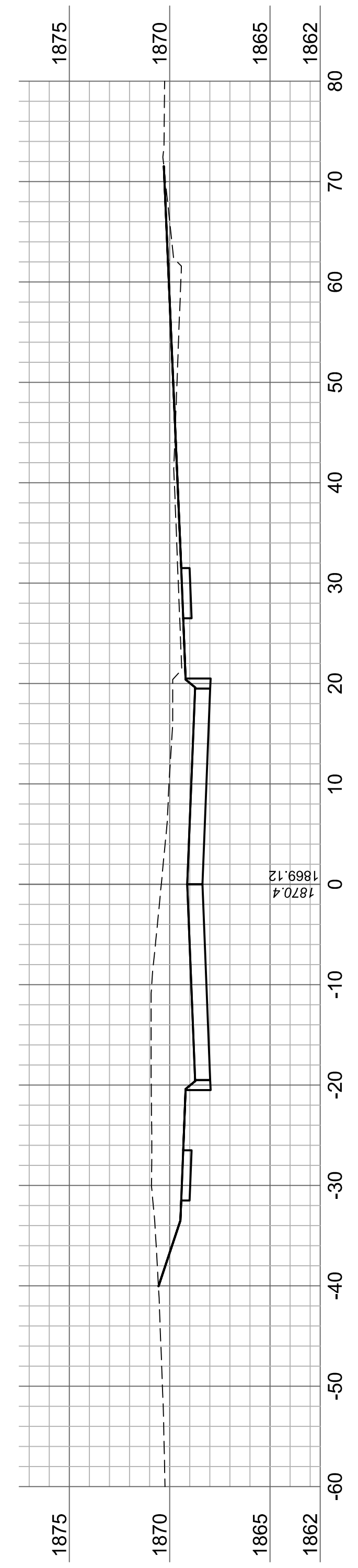

105+75

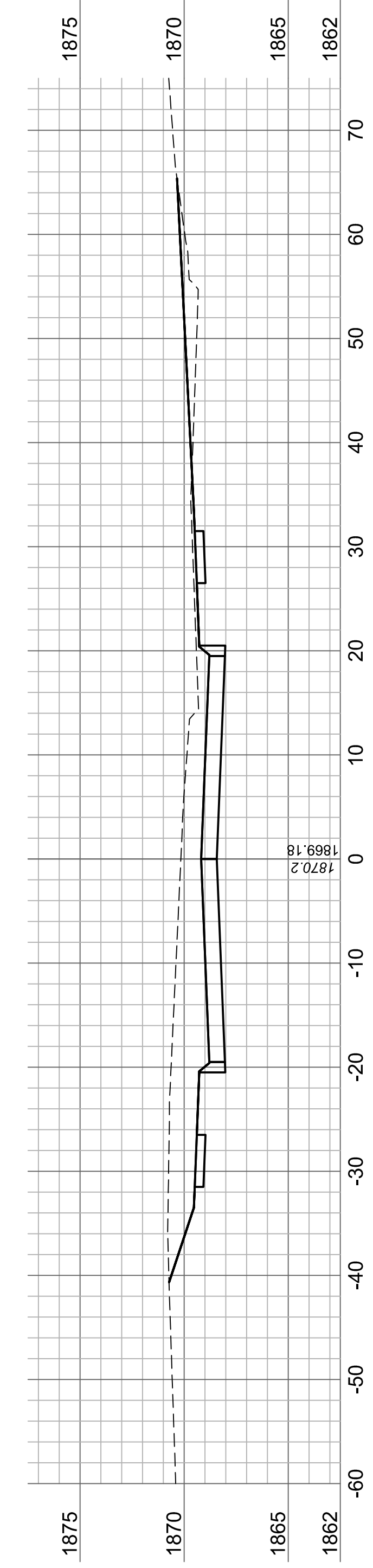

105+50

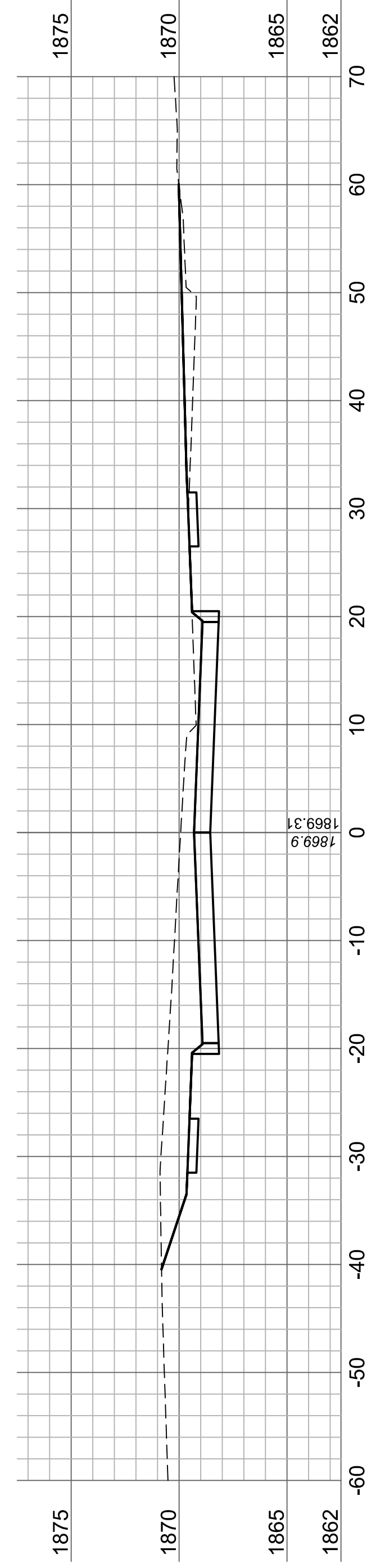

105+25

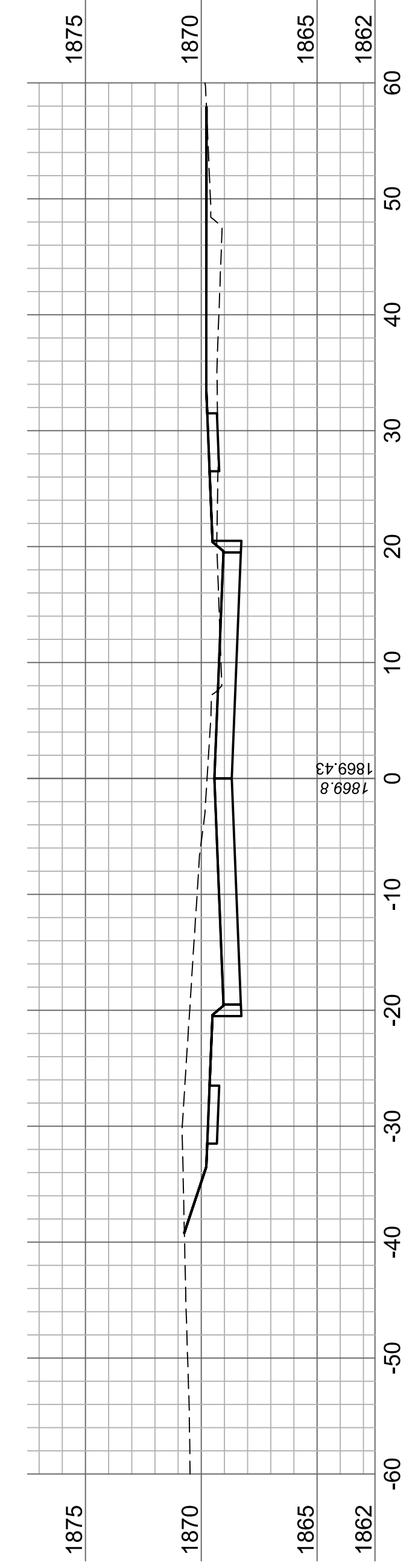

105+00

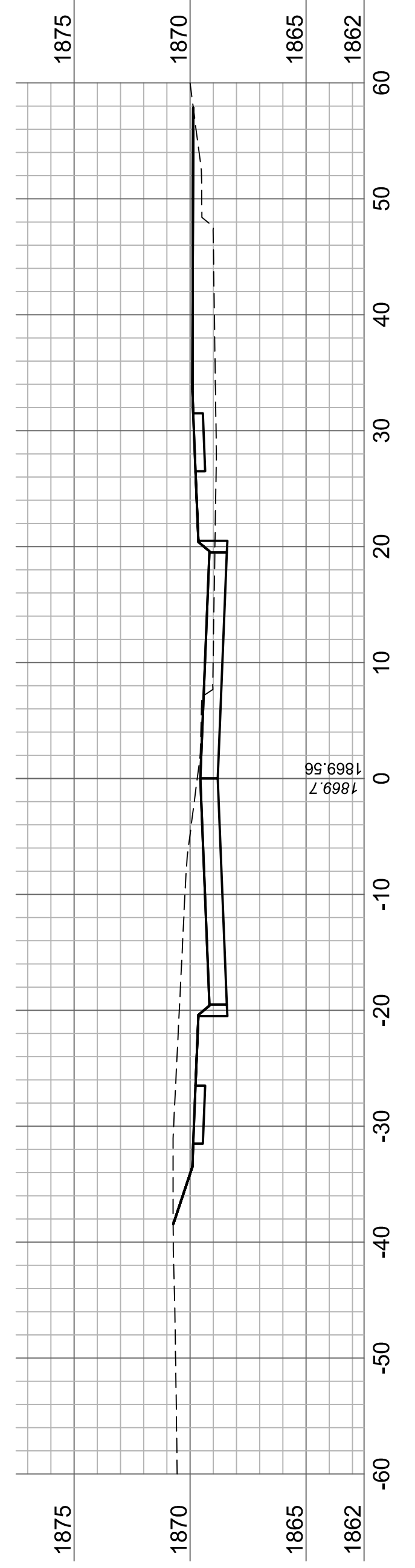

104+75

| | | | | |
|---|--|----------|------|-----------------------|
| CROSS SECTIONS STA. 104+75 TO STA. 106+00 | | REV. NO. | DATE | REVISIONS DESCRIPTION |
| 18TH STREET - MOORES CREEK TO DIERS AVENUE ROADWAY IMPROVEMENTS; PROJECT #2022-P-8 | | | | |
| GRAND ISLAND, NEBRASKA | | | | |
| | | | | REVISIONS |

drawn by: _____
 checked by: _____
 approved by: _____
 QA/QC by: _____
 project no.: 021-07494
 drawing no.: _____
 date: 10.17.2022

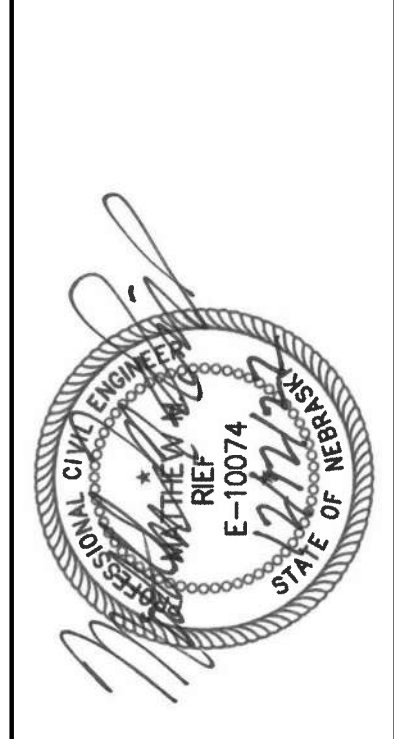

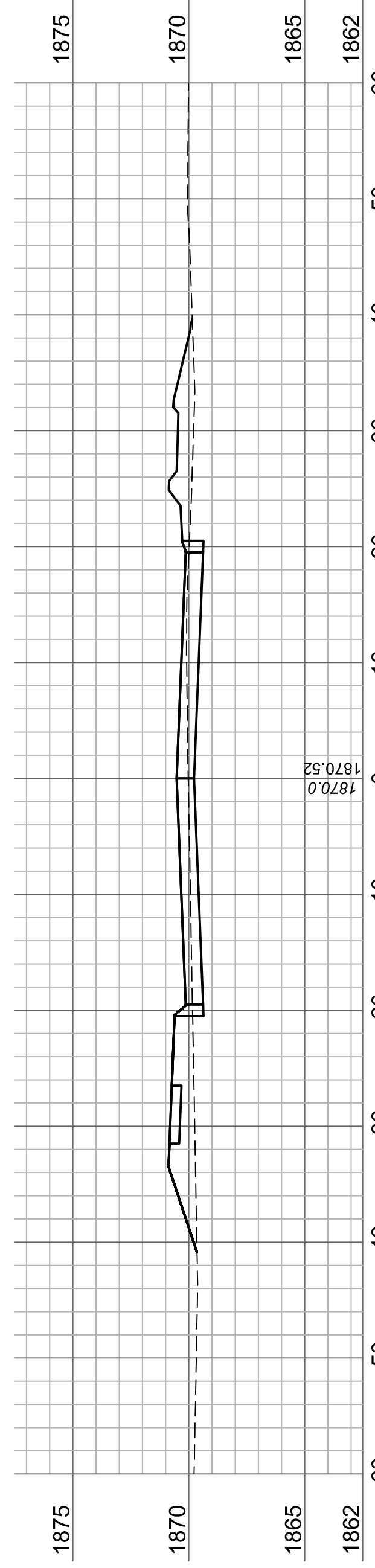

108+75

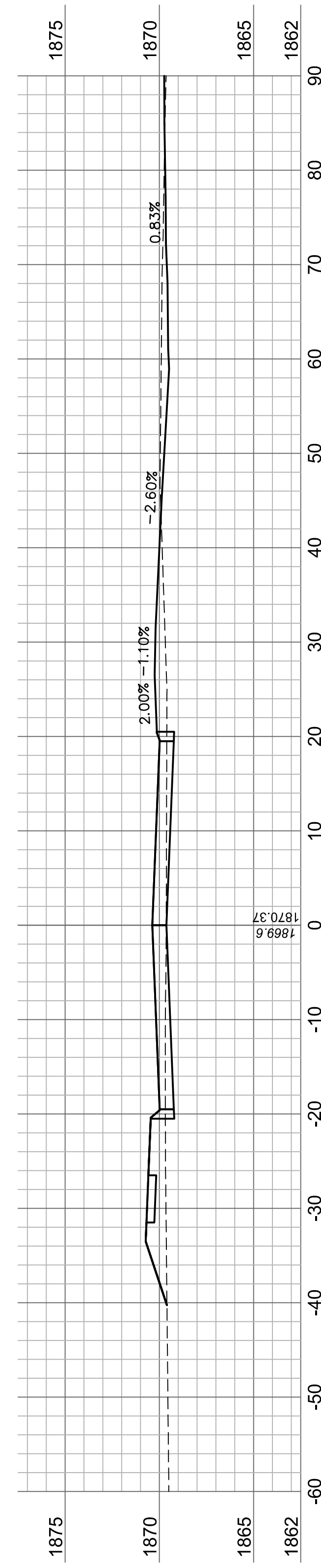

108+50

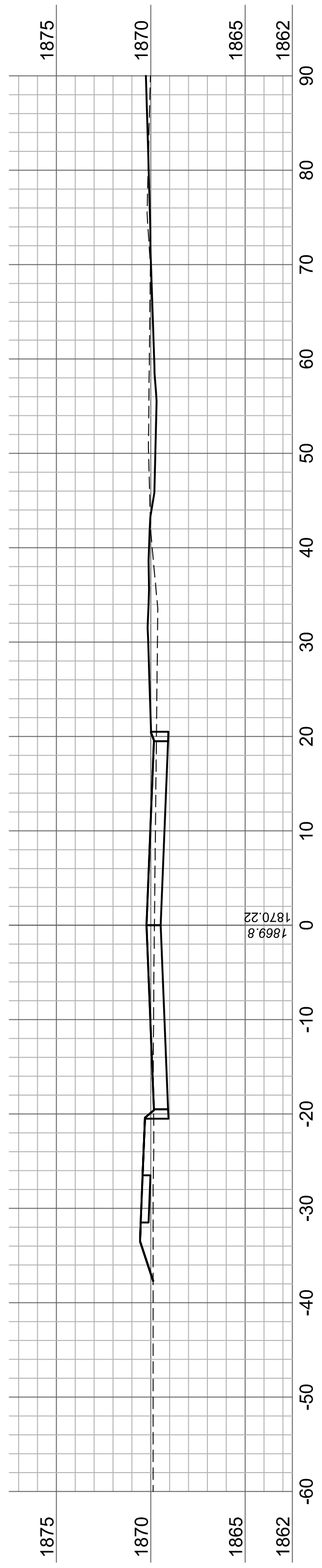

108+25

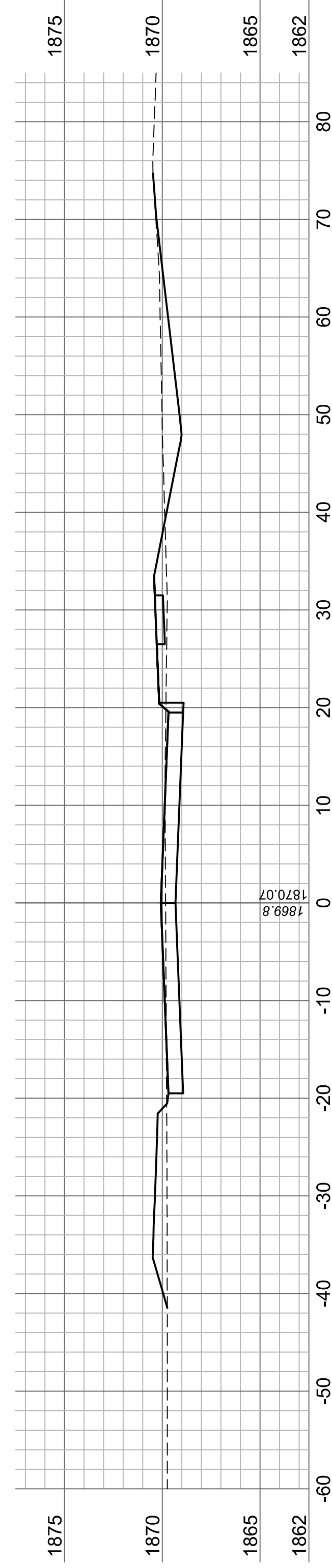

108+00

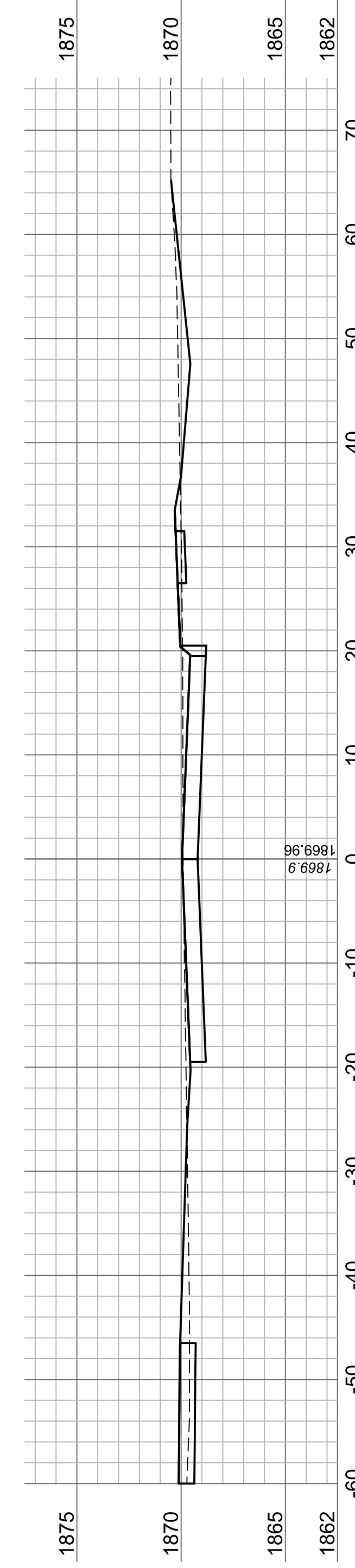

107+75

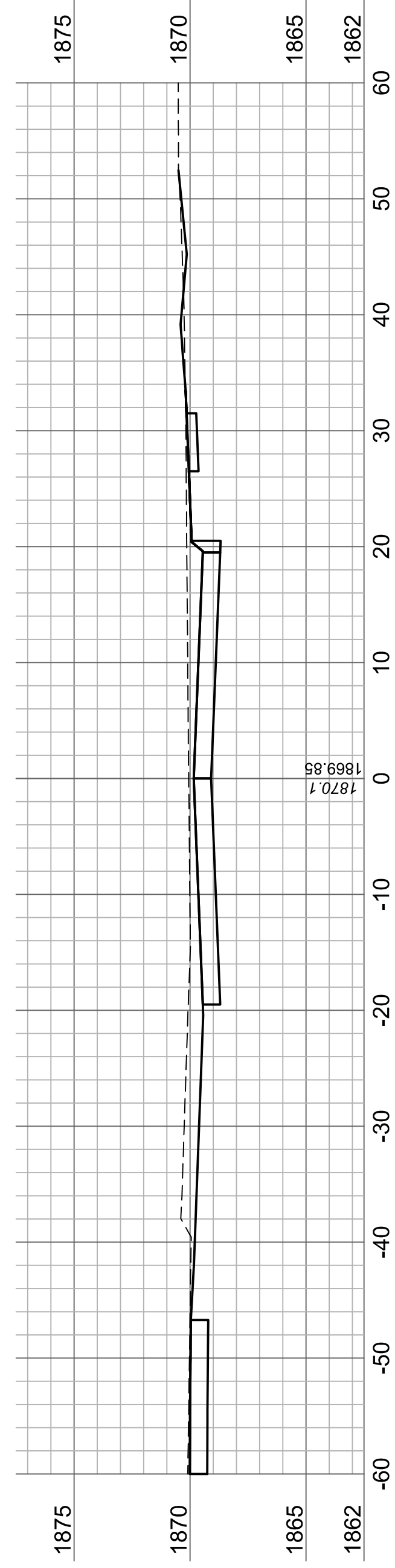

107+50

| | | | | |
|---|--|----------|------|-----------------------|
| CROSS SECTIONS STA. 107+50 TO STA. 108+50 | | REV. NO. | DATE | REVISIONS DESCRIPTION |
| 18TH STREET - MOORES CREEK TO DIERS AVENUE ROADWAY IMPROVEMENTS; PROJECT #2022-P-8 | | | | |
| GRAND ISLAND, NEBRASKA | | | | |
| | | | | REVISIONS |

| | |
|--------------|------------|
| drawn by: | |
| checked by: | |
| approved by: | |
| QA/QC by: | |
| project no.: | 021-07494 |
| drawing no.: | |
| date: | 10.17.2022 |

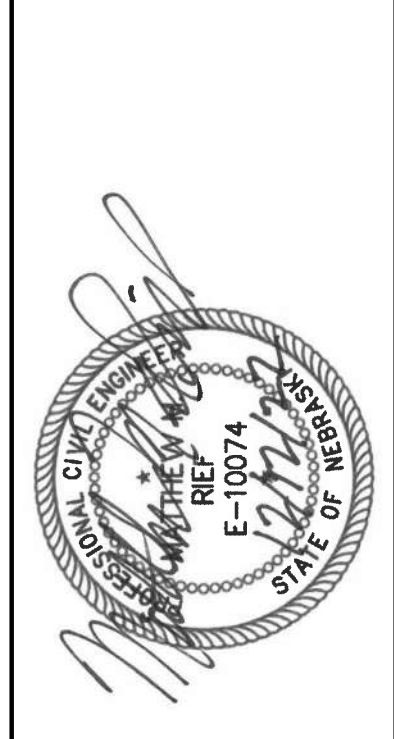

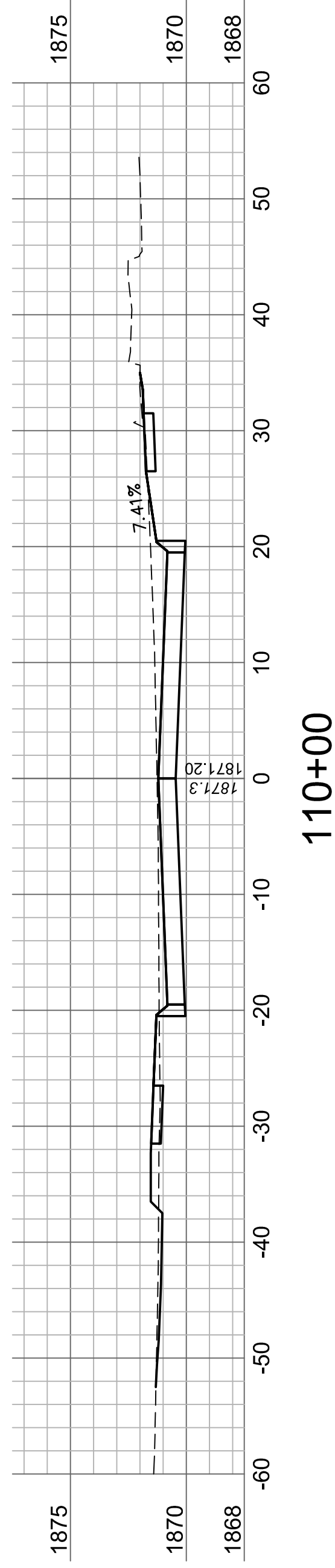

110+00

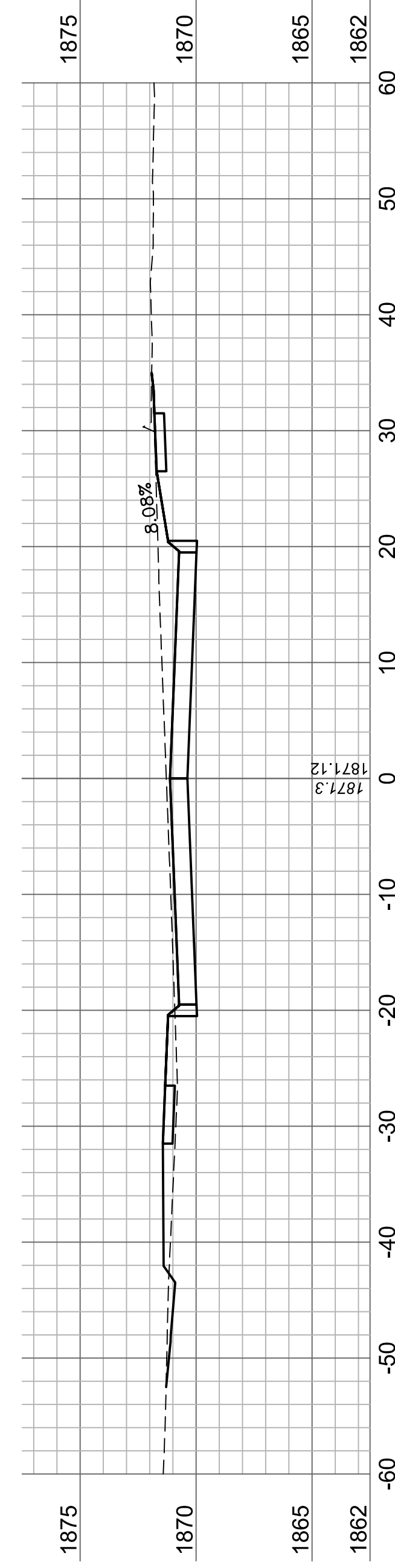

109+75

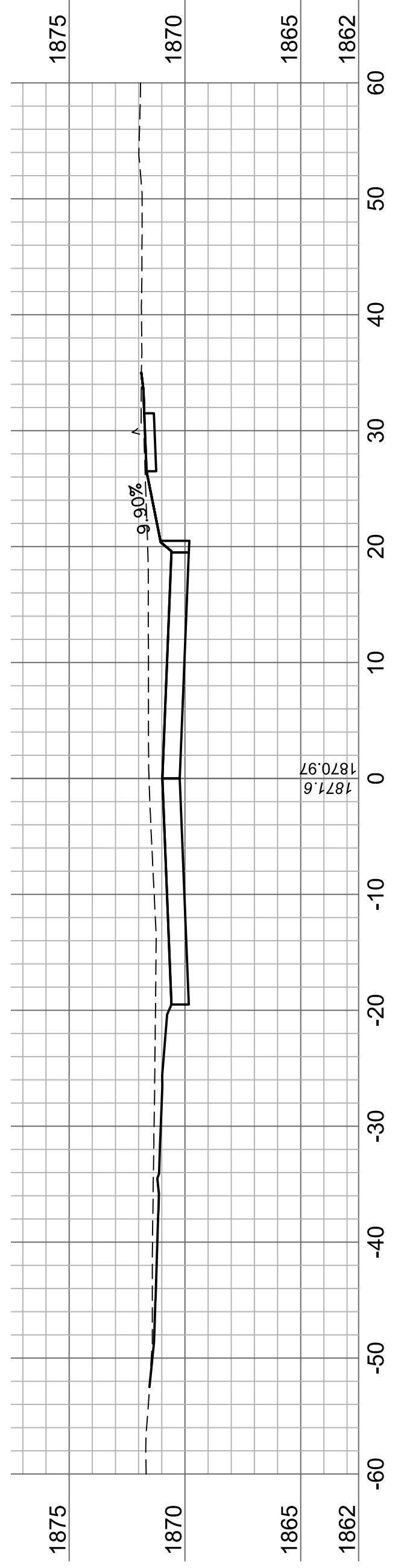

109+50

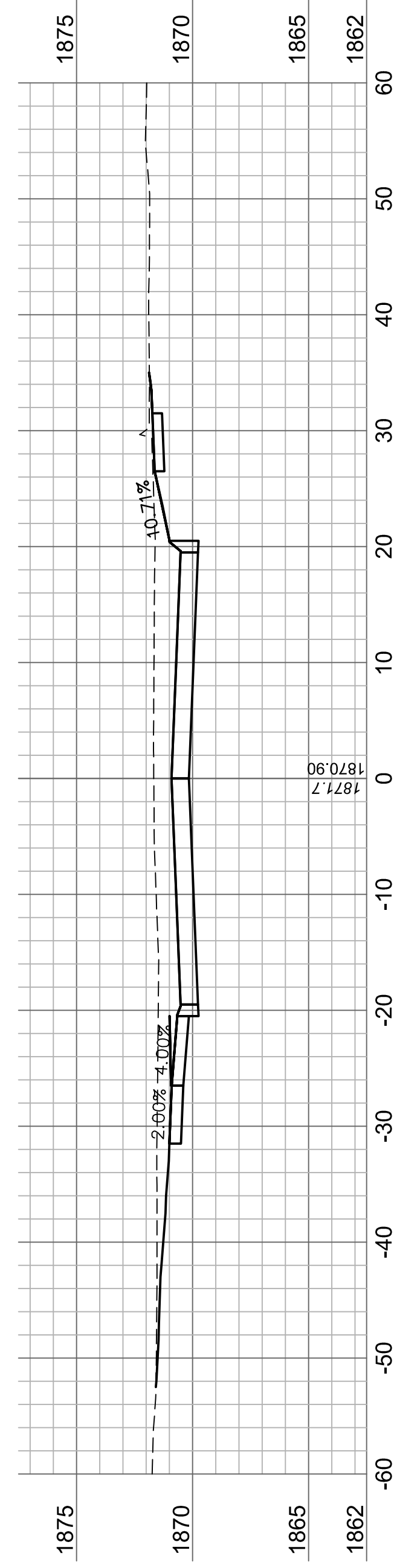

109+38.85

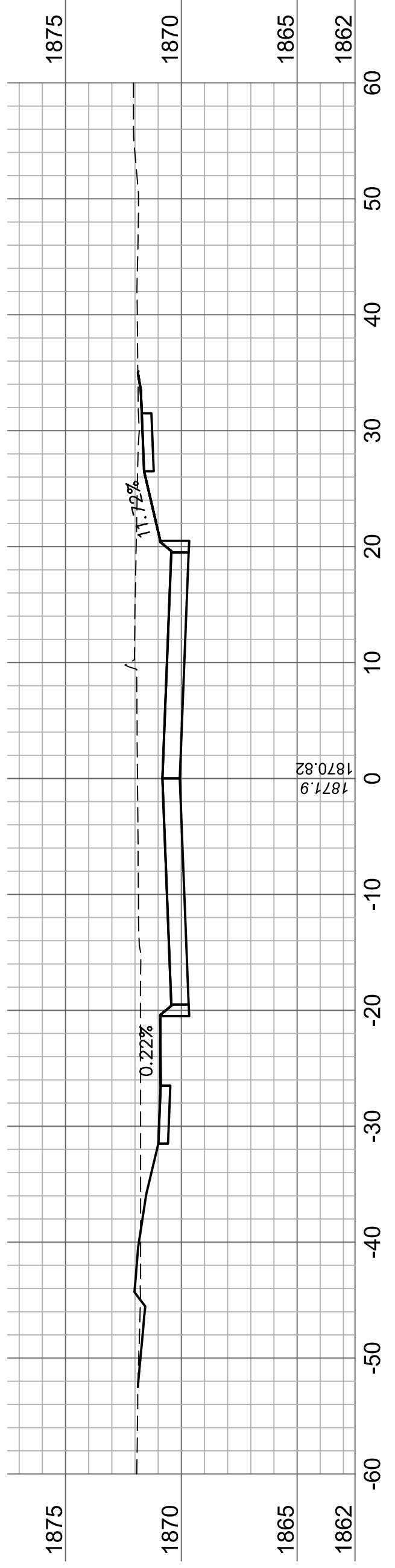

109+25

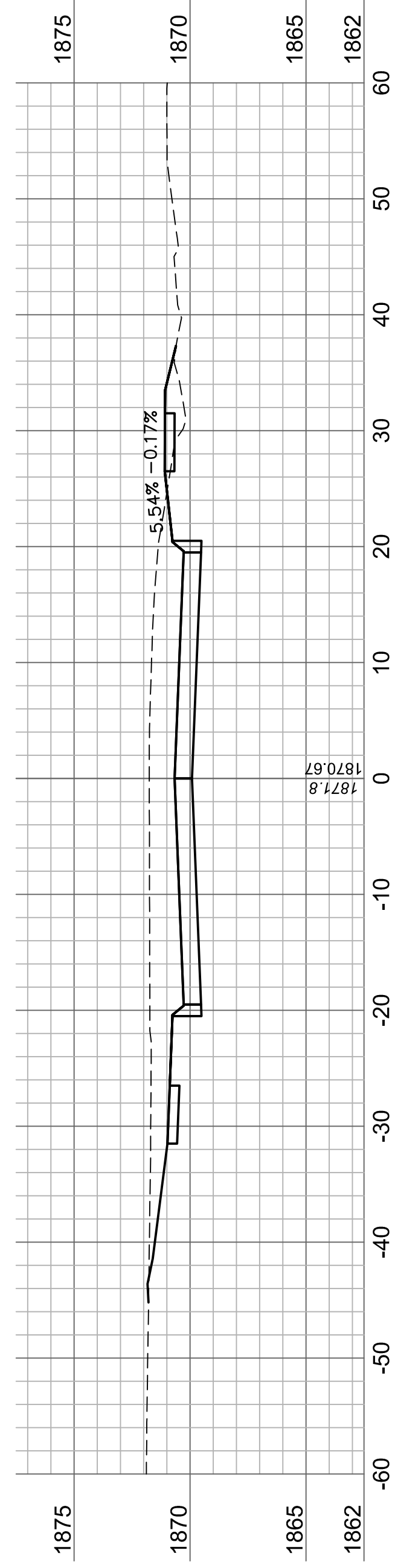

109+00

drawn by: _____
 checked by: _____
 approved by: _____
 QA/QC by: _____
 project no.: 021-07494
 drawing no.: _____
 date: 10.17.2022

| CROSS SECTIONS | | REV. NO. | DATE | REVISIONS DESCRIPTION |
|--|--|----------|------|-----------------------|
| STA. 108+75 TO STA. 109+75 | | | | |
| 18TH STREET - MOORES CREEK TO DIERS AVENUE | | | | |
| ROADWAY IMPROVEMENTS; PROJECT #2022-P-8 | | | | |
| GRAND ISLAND, NEBRASKA | | | | |
| | | | | REVISIONS |

| REV. NO. | DATE | REVISIONS DESCRIPTION |
|----------|------|-----------------------|
| | | |
| | | |
| | | |
| | | |
| | | |
| | | |
| | | |
| | | |
| | | |

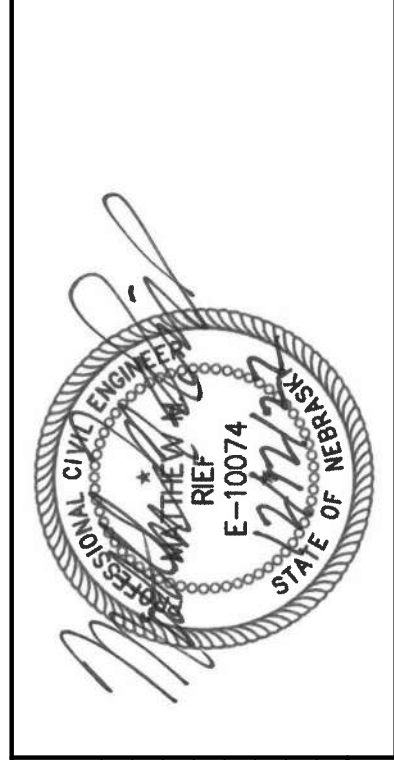

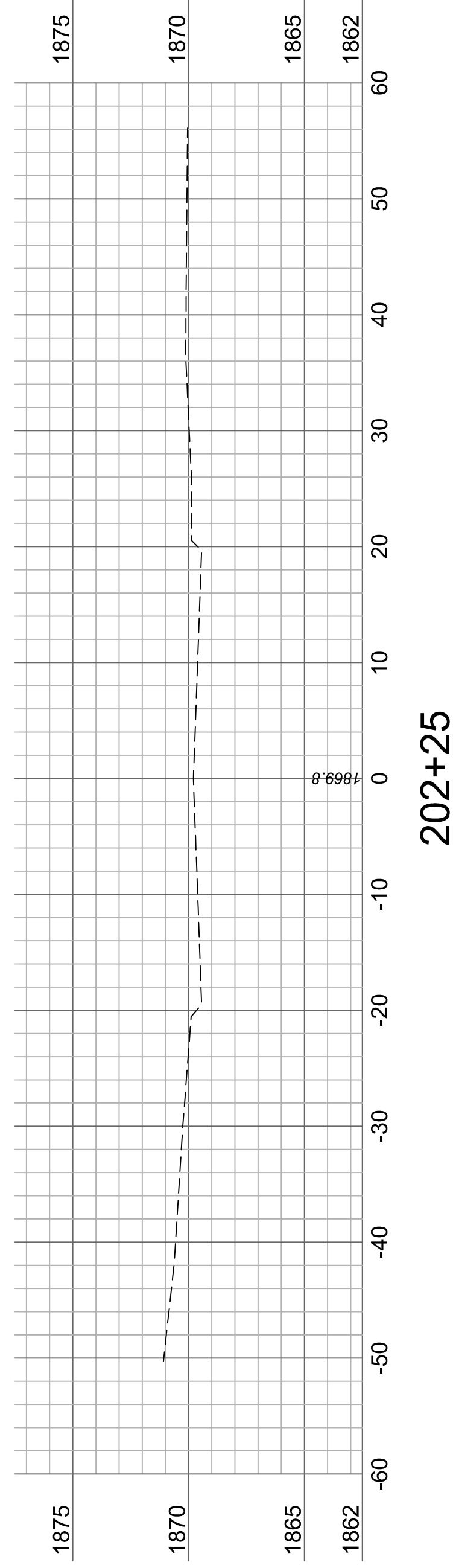

202+25

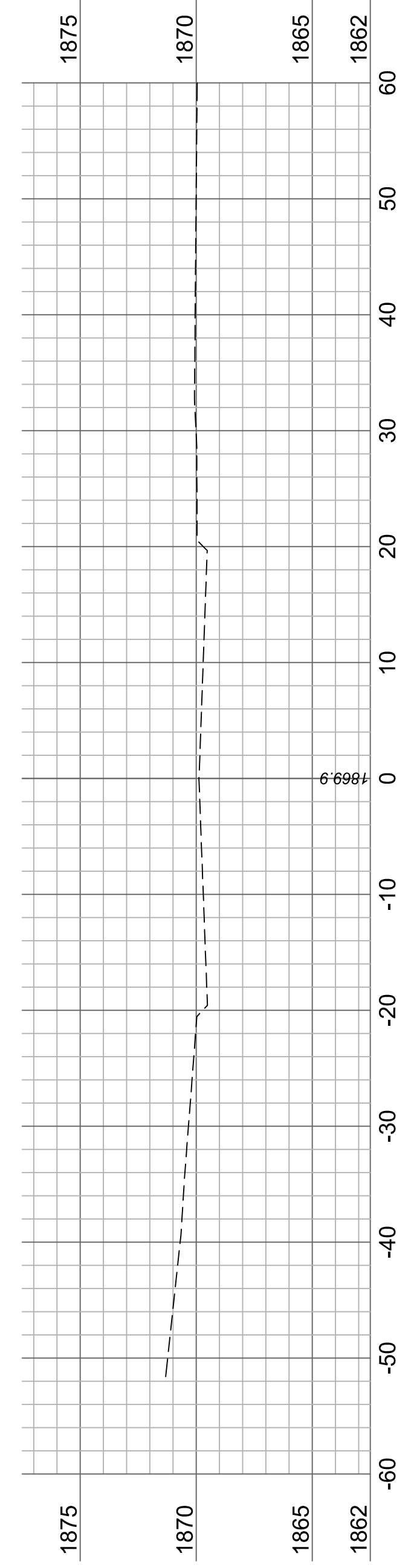

202+00

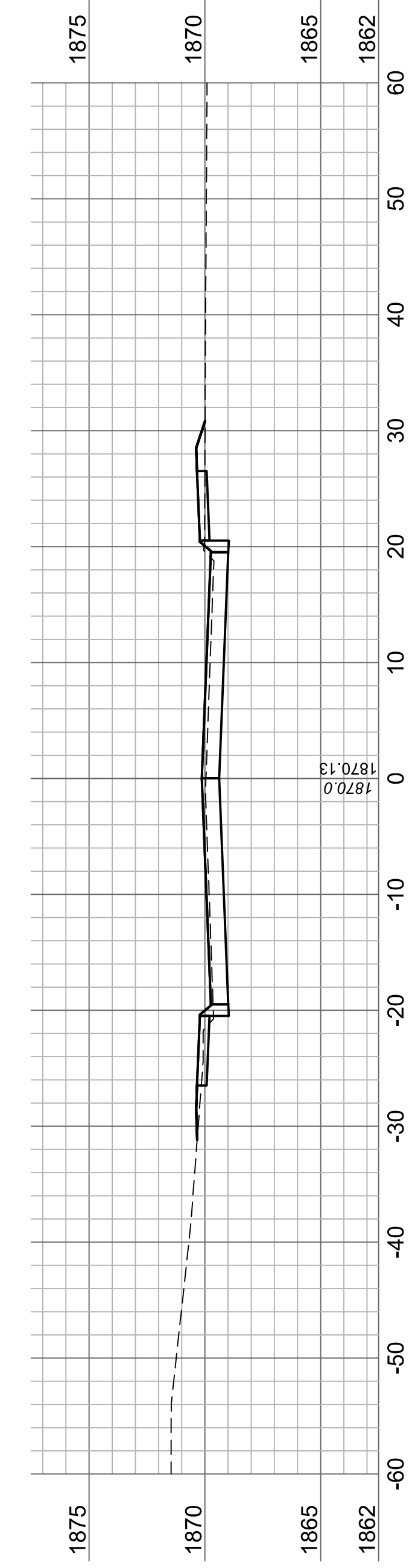

201+75

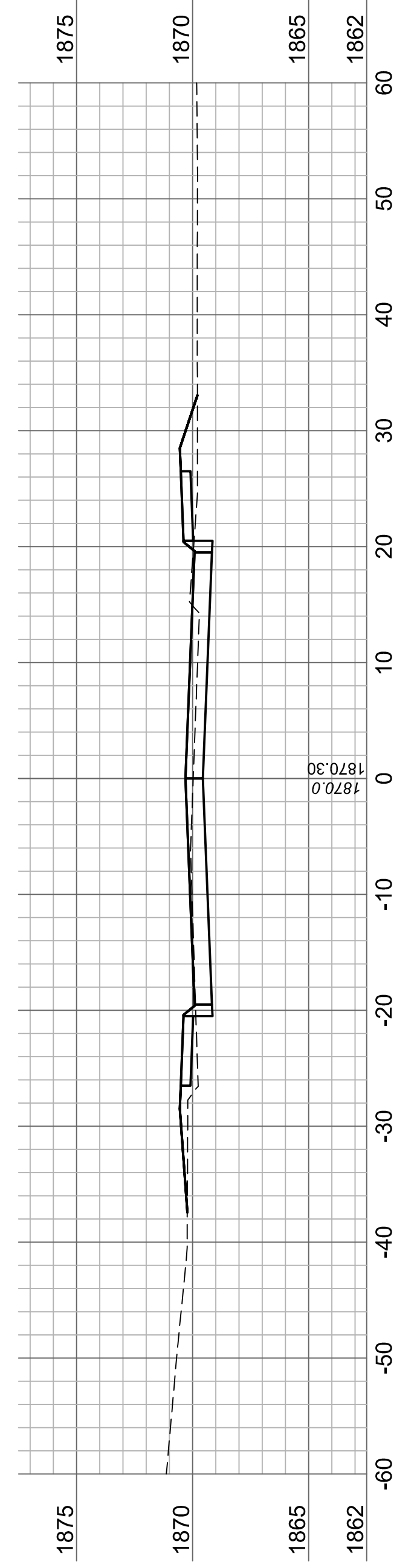

201+50

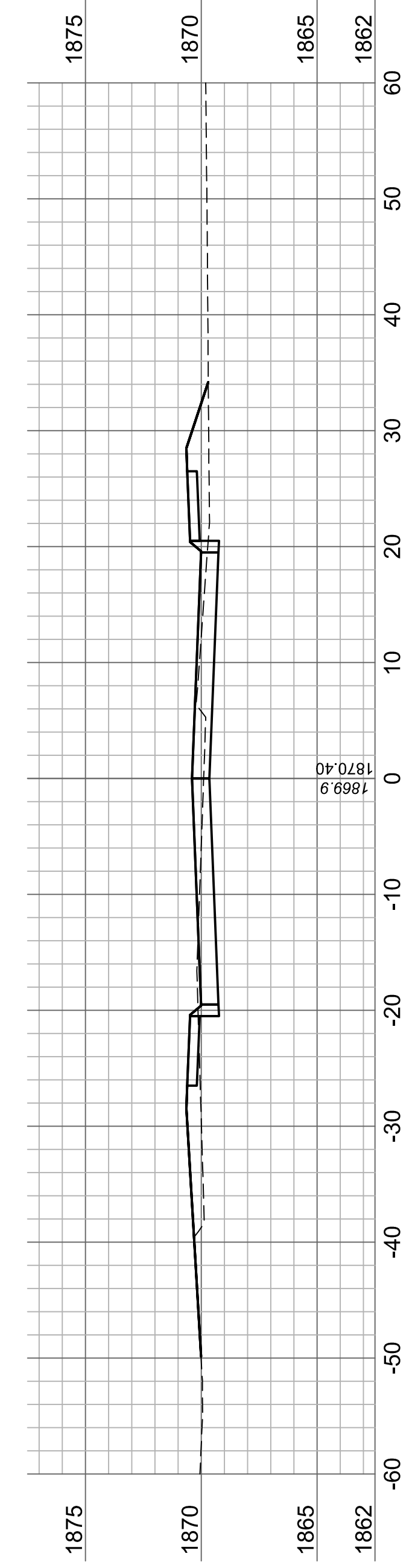

201+25

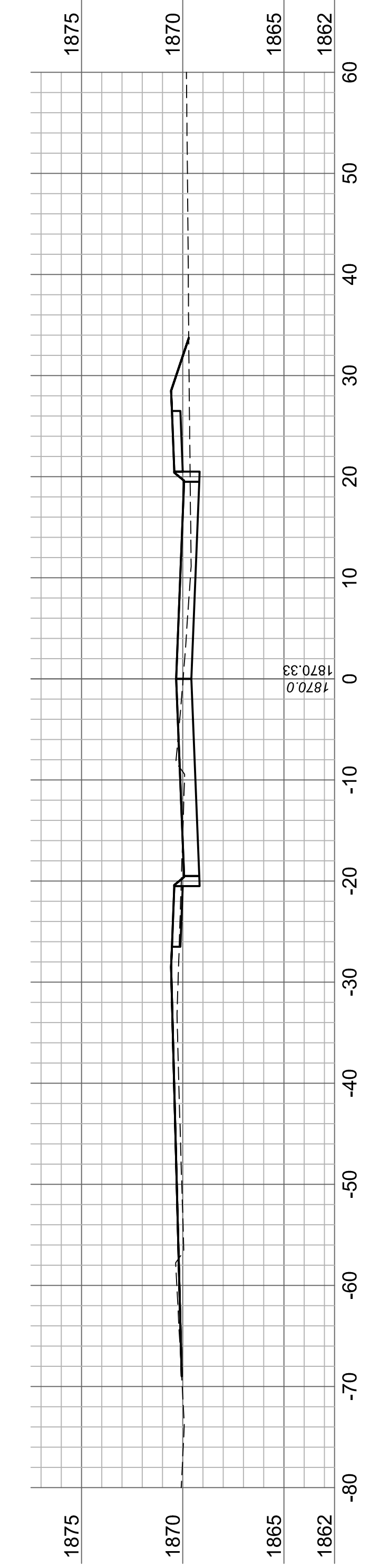

201+00

drawn by: _____
 checked by: _____
 approved by: _____
 QA/QC by: _____
 project no.: 021-07494
 drawing no.: _____
 date: 10.17.2022

| CROSS SECTIONS | | REV. NO. | DATE | REVISIONS DESCRIPTION |
|--|--|----------|------|-----------------------|
| STA. 201+00 TO STA. 202+25 | | | | |
| 18TH STREET - MOORES CREEK TO DIERS AVENUE | | | | |
| ROADWAY IMPROVEMENTS; PROJECT #2022-P-8 | | | | |
| GRAND ISLAND, NEBRASKA | | | | |
| | | | | REVISIONS |

| REV. NO. | DATE | REVISIONS DESCRIPTION |
|----------|------|-----------------------|
| | | |
| | | |
| | | |
| | | |
| | | |
| | | |
| | | |
| | | |
| | | |

